

SERVICE MANUAL

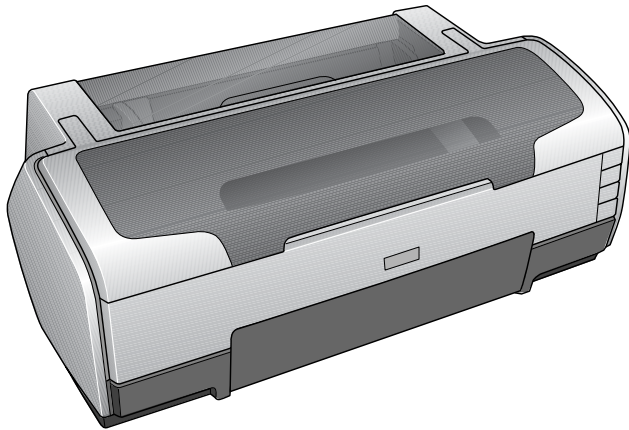

Color Inkjet Printer

EPSON Stylus Photo 1390/1400/1410

EPSON
EXCEED YOUR VISION

SEIJ06009

Notice:

- All rights reserved. No part of this manual may be reproduced, stored in a retrieval system, or transmitted in any form or by any means, electronic, mechanical, photocopying, recording, or otherwise, without the prior written permission of SEIKO EPSON CORPORATION.
- The contents of this manual are subject to change without notice.
- All effort have been made to ensure the accuracy of the contents of this manual. However, should any errors be detected, SEIKO EPSON would greatly appreciate being informed of them.
- The above notwithstanding, SEIKO EPSON CORPORATION can assume no responsibility for any errors in this manual or the consequences thereof.

EPSON is a registered trademark of SEIKO EPSON CORPORATION.

General Notice: Other product names used herein are for identification purpose only and may be trademarks or registered trademarks of their respective owners. EPSON disclaims any and all rights in those marks.

PRECAUTIONS

Precautionary notations throughout the text are categorized relative to 1) personal injury and 2) damage to equipment.

DANGER Signals a precaution which, if ignored, could result in serious or fatal personal injury. Great caution should be exercised in performing procedures preceded by DANGER Headings.

WARNING Signals a precaution which, if ignored, could result in damage to equipment.

The precautionary measures itemized below should always be observed when performing repair/maintenance procedures.

DANGER

1. ALWAYS DISCONNECT THE PRODUCT FROM THE POWER SOURCE AND PERIPHERAL DEVICES BEFORE PERFORMING ANY MAINTENANCE OR REPAIR PROCEDURES.
2. NO WORK SHOULD BE PERFORMED ON THE UNIT BY PERSONS UNFAMILIAR WITH BASIC SAFETY MEASURES AS DICTATED FOR ALL ELECTRONICS TECHNICIANS IN THEIR LINE OF WORK.
3. WHEN PERFORMING TESTING AS DICTATED WITHIN THIS MANUAL, DO NOT CONNECT THE UNIT TO A POWER SOURCE UNTIL INSTRUCTED TO DO SO. WHEN THE POWER SUPPLY CABLE MUST BE CONNECTED, USE EXTREME CAUTION IN WORKING ON POWER SUPPLY AND OTHER ELECTRONIC COMPONENTS.
4. WHEN DISASSEMBLING OR ASSEMBLING A PRODUCT, MAKE SURE TO WEAR GLOVES TO AVOID INJURIES FROM METAL PARTS WITH SHARP EDGES.

WARNING

1. REPAIRS ON EPSON PRODUCT SHOULD BE PERFORMED ONLY BY AN EPSON CERTIFIED REPAIR TECHNICIAN.
2. MAKE CERTAIN THAT THE SOURCE VOLTAGE IS THE SAME AS THE RATED VOLTAGE, LISTED ON THE SERIAL NUMBER/RATING PLATE. IF THE EPSON PRODUCT HAS A PRIMARY AC RATING DIFFERENT FROM AVAILABLE POWER SOURCE, DO NOT CONNECT IT TO THE POWER SOURCE.
3. ALWAYS VERIFY THAT THE EPSON PRODUCT HAS BEEN DISCONNECTED FROM THE POWER SOURCE BEFORE REMOVING OR REPLACING PRINTED CIRCUIT BOARDS AND/OR INDIVIDUAL CHIPS.
4. IN ORDER TO PROTECT SENSITIVE MICROPROCESSORS AND CIRCUITRY, USE STATIC DISCHARGE EQUIPMENT, SUCH AS ANTI-STATIC WRIST STRAPS, WHEN ACCESSING INTERNAL COMPONENTS.
5. DO NOT REPLACE IMPERFECTLY FUNCTIONING COMPONENTS WITH COMPONENTS WHICH ARE NOT MANUFACTURED BY EPSON. IF SECOND SOURCE IC OR OTHER COMPONENTS WHICH HAVE NOT BEEN APPROVED ARE USED, THEY COULD CAUSE DAMAGE TO THE EPSON PRODUCT, OR COULD VOID THE WARRANTY OFFERED BY EPSON.
6. WHEN USING COMPRESSED AIR PRODUCTS; SUCH AS AIR DUSTER, FOR CLEANING DURING REPAIR AND MAINTENANCE, THE USE OF SUCH PRODUCTS CONTAINING FLAMMABLE GAS IS PROHIBITED.

About This Manual

This manual describes basic functions, theory of electrical and mechanical operations, maintenance, and repair procedures of the printer. The instructions and procedures included herein are intended for the experienced repair technicians, and attention should be given to the precautions on the preceding page.

Manual Configuration

This manual consists of six chapters and Appendix.

CHAPTER 1. PRODUCT DESCRIPTIONS

Provides a general overview and specifications of the product.

CHAPTER 2. OPERATING PRINCIPLES

Describes the theory of electrical and mechanical operations of the product.

CHAPTER 3. TROUBLESHOOTING

Describes the step-by-step procedures for the troubleshooting.

CHAPTER 4. DISASSEMBLY / ASSEMBLY

Describes the step-by-step procedures for disassembling and assembling the product.

CHAPTER 5. ADJUSTMENT

Provides Epson-approved methods for adjustment.

CHAPTER 6. MAINTENANCE

Provides preventive maintenance procedures and the list of Epson-approved lubricants and adhesives required for servicing the product.

APPENDIX Provides the following additional information for reference:

- Connector summary
- Electric circuit diagrams

Symbols Used in this Manual

Various symbols are used throughout this manual either to provide additional information on a specific topic or to warn of possible danger present during a procedure or an action. Be aware of all symbols when they are used, and always read NOTE, CAUTION, and WARNING messages.



Indicates an operating or maintenance procedure, practice or condition that, if not strictly observed, could result in injury.



Indicates an operating or maintenance procedure, practice, or condition that, if not strictly observed, could result in damage to, or destruction of equipment.



May indicate an operating or maintenance procedure, practice or condition that is necessary to accomplish a task efficiently. It may also provide additional information that is related to a specific subject, or comment on the results achieved through a previous action.



Indicates a product reassembly procedure, practice or condition that must be executed in accordance with the specified standards to maintain the product's quality.



Indicates an operating or maintenance procedure, practice or condition that must be executed in accordance with the specified standards to maintain the product's quality.

Revision Status

Revision	Date of Issue	Description
A	October 20, 2006	First Release
B	January 17, 2007	<p>All Chapters:</p> <ul style="list-style-type: none"> • Check points and notes are added to provide information specific to Stylus Photo 1390. <p>Chapter 1:</p> <ul style="list-style-type: none"> • 1.1"Overview" (Page 9) Features are modified. • 1.6"Accessories" (Page 20) Information on the ink cartridge of Stylus Photo 1390 is added. <p>Chapter 4:</p> <ul style="list-style-type: none"> • 4.2"Disassembly/Assembly Procedures" (Page 76) Flowchart for Stylus Photo 1390 is added. • 4.3"Procedure Specific to Stylus Photo 1390" (Page 128) Disassembly procedures specific to Stylus Photo 1390 are added. <p>Chapter 5:</p> <ul style="list-style-type: none"> • 5.1.1"Servicing Adjustment Item List" (Page 132) Description of Bi-D Adjustment is corrected. <p>Chapter 7:</p> <ul style="list-style-type: none"> • 7.3"Electrical Circuit Diagrams" (Page 162) Electrical Circuit Diagrams of C655 Main1 is revised.

Contents

Chapter 1 PRODUCT DESCRIPTION

1.1 Overview	9
1.2 Printing Area	10
1.2.1 Printing Area (Cut sheet, Envelope)	11
1.3 PG Setting	16
1.4 Printer Function	17
1.4.1 Operator Controls	17
1.4.2 Buttons	17
1.4.3 LED Indicators	17
1.4.4 Panel Functions	17
1.4.5 Printer Condition and Panel LED Status	18
1.4.6 Errors	19
1.5 Size and Weight	20
1.6 Accessories	20

Chapter 2 OPERATING PRINCIPLES

2.1 Overview	22
2.2 Printer Mechanism	22
2.2.1 Carriage Mechanism	23
2.2.2 Printhead Specifications	26
2.2.3 Paper Feeding Mechanism	26
2.2.4 Paper Feeding Mechanism	30
2.2.5 Ink System Mechanism	31
2.2.6 Ink Sequence	33
2.2.7 Power-On Sequence	34
2.3 Electrical Circuit Operating Principles	35
2.3.1 Power Supply Circuit Operating Principle	36
2.3.2 C655 MAIN Circuit Operating Principle	37

Chapter 3 TROUBLESHOOTING

3.1 Overview	40
3.1.1 Troubleshooting according to Panel Messages	40
3.1.2 Troubleshooting based on Observed Faults	62

Chapter 4 DISASSEMBLY AND ASSEMBLY

4.1 Overview	72
4.1.1 Precautions	72
4.1.2 Tools	73
4.1.3 Screws	73
4.1.4 Work Completion Checklist	74
4.1.5 Sharp Metal Edges	75
4.1.6 Method for making CSIC board removal tool	75
4.2 Disassembly/Assembly Procedures	76
4.2.1 Removing the Housings	78
4.2.2 Waste Ink Pad	84
4.2.3 Front Paper Guide Pad	85
4.2.4 ASF Assy	86
4.2.5 Removing the Boards	90
4.2.6 Disassembling the Printer Mechanism	92
4.2.7 Removing the Motors	122
4.2.8 Removing the Sensors	124
4.3 Procedure Specific to Stylus Photo 1390	128
4.3.1 Upper Housing	128
4.3.2 Paper EJ Frame Assy	129

Chapter 5 ADJUSTMENT

5.1 Adjustment Items and Overview	132
5.1.1 Servicing Adjustment Item List.....	132
5.1.2 Replacement Part-Based Adjustment Priorities.....	135
5.1.3 Required Adjustment Tools	137
5.2 Adjustment	137
5.2.1 PF Belt Tension Adjustment.....	137
5.2.2 PG Adjustment.....	139
5.2.3 PF Roller Shaft Center Support Position Adjustment	144

Chapter 6 MAINTENANCE

6.1 Overview	149
6.1.1 ROM Replacement	149
6.1.2 Cleaning.....	149
6.1.3 Service Maintenance.....	150
6.1.4 Lubrication.....	151

Chapter 7 APPENDIX

7.1 Connector Summary	158
7.1.1 Connectors and Pin Layouts	158
7.2 Exploded Diagrams and Parts List	162
7.3 Electrical Circuit Diagrams	162

CHAPTER

1

PRODUCT DESCRIPTION

1.1 Overview

EPSON Stylus Photo 1390/1400/1410 is a color inkjet printer designed for a wide range of users, from home use to office use. The main features of this printer are:

Features of Stylus Photo 1390/1400/1410

- EPSON's latest dye ink ensures high levels of lightfastness and gasfastness
- Six individually replaceable ink cartridges
- Offers high resolution of up to 5760 x 1440 dpi (dots per inch).
- Supports borderless print on up to A3+ sized paper
- High-quality and high-speed printing

Features exclusive to Stylus Photo 1400/1410

- Direct print on CD-R with the CD/DVD tray
- Direct print from PictBridge- and USB Direct Print-compatible digital cameras

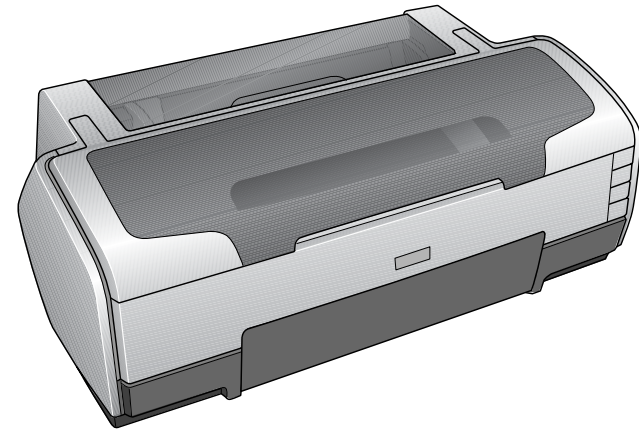

Figure 1-1. External View

1.2 Printing Area

The printing area for this printer is shown below.

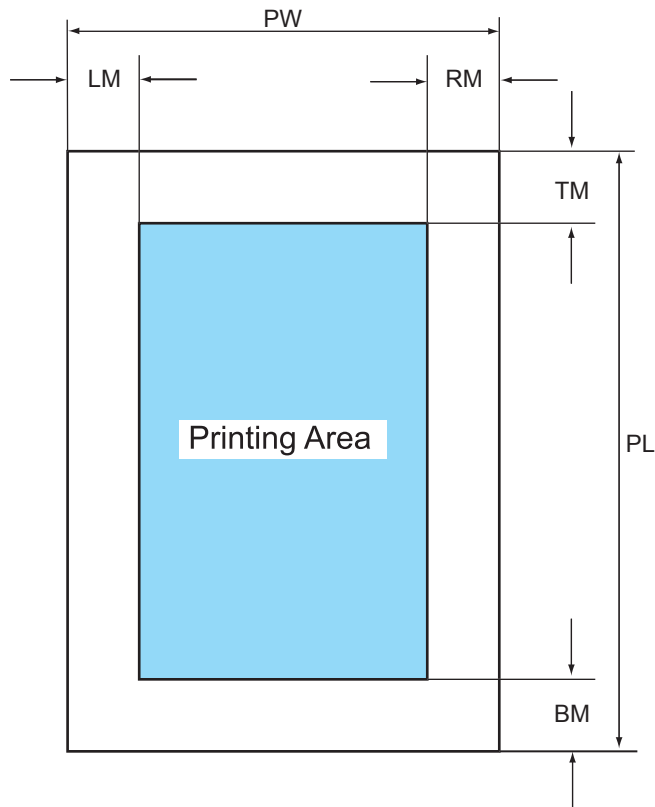

Figure 1-2. Printing Area

Table 1-1. Printing Area

Paper Size	Width (PW)	Length (PL)	Margin			
			Left (LM)	Right (RM)	Top (TM)	Bottom (BM) ^{*1}
A3+	329 mm (12.9 in.)	483 mm (19 in.)	3 mm (0.12 in.) or more	3 mm (0.12 in.) or more	3 mm (0.12 in.) or more	3 mm (0.12 in.) or more
A3	297 mm (11.7 in.)	420 mm (16.5 in.)				
US B ^{*2}	279.4 mm (11 in.)	431.8 mm (17 in.)				
B4	257 mm (10.1 in.)	364 mm (14.3 in.)				
US Legal	216 mm (8.5 in.)	356 mm (14 in.)				
US Letter	216 mm (8.5 in.)	279 mm (10.9 in.)				
A4	210 mm (8.3 in.)	297 mm (11.7 in.)				
B5 ^{*3}	182 mm (7.2 in.)	257 mm (10.1 in.)				
A5 ^{*3}	148 mm (5.8 in.)	210 mm (8.3 in.)				
Half letter ^{*2}	139.7 mm (5.5 in.)	215.9 mm (8.5 in.)				
A6	105 mm (4.1 in.)	148 mm (5.8 in.)				
8x10 ^{*2}	203.2 mm (8 in.)	254 mm (10 in.)				
5x7	127 mm (5 in.)	262 mm (10.3 in.)				
4x6	101.6 mm (4 in.)	152.4 mm (6 in.)				
16:9 Wide	101.6 mm (4 in.)	180.6 mm (7.1 in.)				

Note *1: Bottom margin can be reduced to 3 mm (minimum) by specifying the paper length via ESC (S command, however, print quality may not be acceptable in the area 3 mm to 43.3 mm (0.12 in. to 1.7 in.) from the bottom edge. When paper length is not specified, the bottom margin will be 3 mm or more.

*2: EAI models only.

*3: Except for EAI models.

Note 1: Under the specific conditions, margins on all sides can be reduced to 0 mm.

2: Under the specific conditions, margins on both left and right sides can be reduced to 0 mm.

1.2.1 Printing Area (Cut sheet, Envelope)

Printing area (Print with borders)

Figure 1-3 shows the printing area (A, B, and C) for cut sheet and envelope. Print quality may be fluctuated in printing area B, and both printing area B and C are subject to being rubbed off by the Printhead. Margins on all sides are designed to prevent the printed images from running off the paper.

Table 1-2. Printing Area

Paper Type	Printing Area B	Printing Area C
Cut sheet	43.3 mm (1.7 in.)	40.1 mm (1.58 in.)
Envelope	20 mm (0.79 in.)	40.1 mm (1.58 in.)

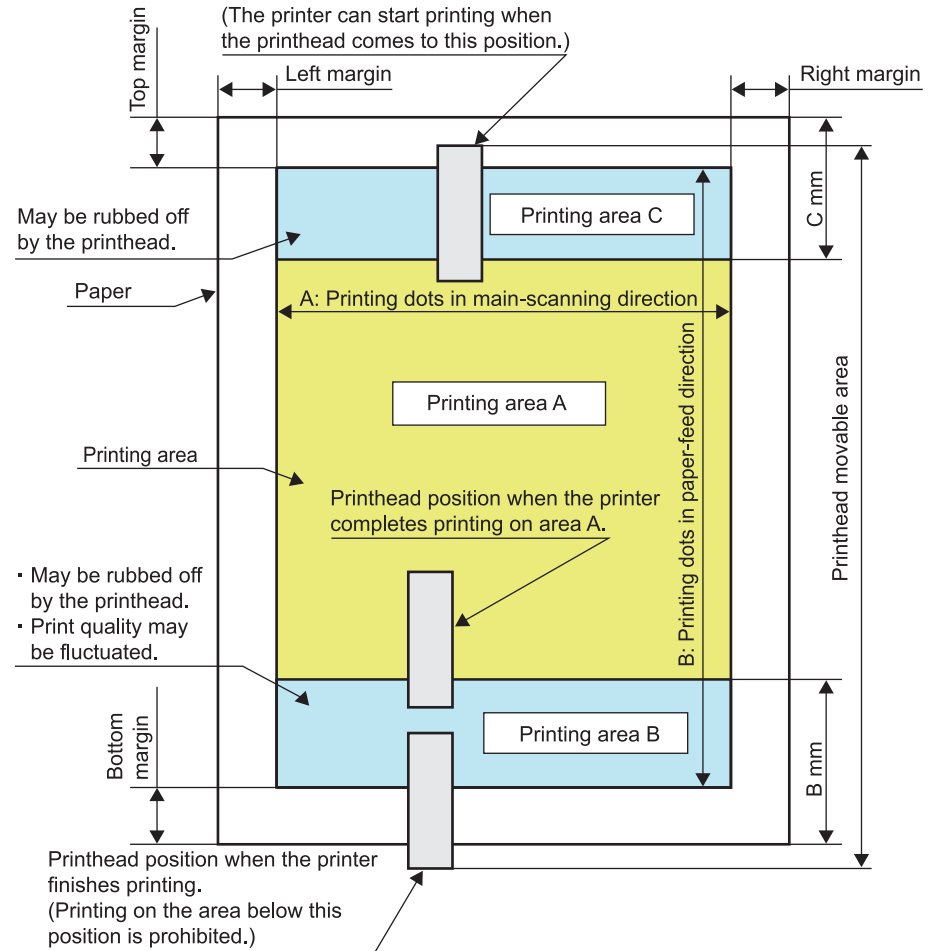

Figure 1-3. Printing Area (Print with Borders)

Printing area (Border-free printing)

Figure 1-4 shows the printing area (A, B, C, and D) when border-free printing is selected. Printing area D is supposed to be trimmed and may not be printed. Border-free printing is available on the following media sizes:

- Paper width
 - 54, 55, 89, 100, 127, 210 mm
 - 4, 5, 8, 8.5 inch

Table 1-3. Printing Area Off the Paper Edges

Margin	4x6	A4/Letter or smaller	A3+ or smaller
Top	19/360" (1.34 mm)	42/360" (2.96 mm)	42/360" (2.96 mm)
Left/ Right	36/360" (2.54 mm)	36/360" (2.54 mm)	49/360" (3.46 mm)
Bottom	36/360" (2.54 mm.)	57/360" (4.02 mm)	64/360" (4.52 mm)

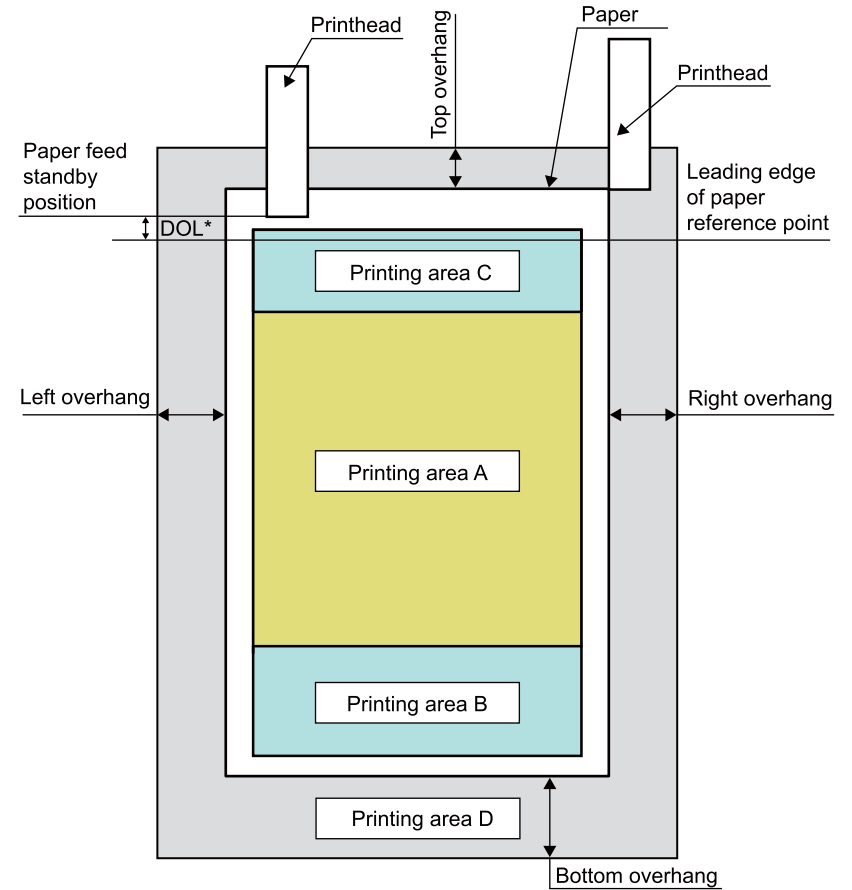

*: 2.96 mm (168/1440")
 Length from leading edge of paper reference point to paper feed standby position

Figure 1-4. Printing Area (Border-free Printing)

Printhead movable area

Figure 1-5 to Figure 1-9 show movable area of the printhead in relation to the printing area in sub-scanning (paper-feed) direction.

□ Top edge

(1) When top margin is set to 3 mm (0.12 in.)

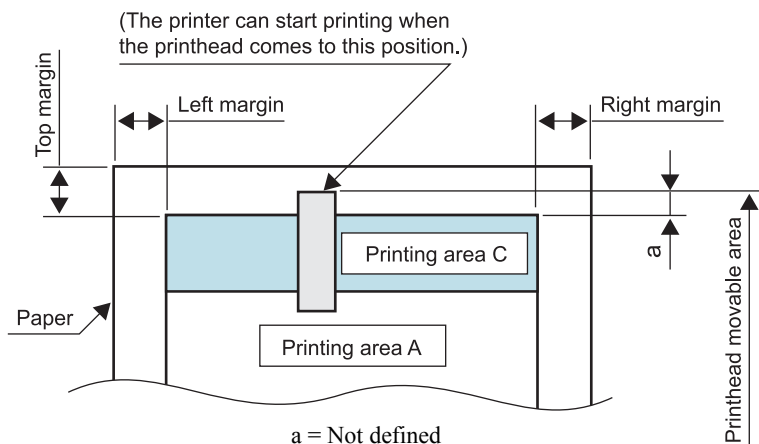

Figure 1-5. Printhead Movable Area (3-mm Top Margin)

(2) When top margin is set to 0 mm
 During printing the area indicated by the arrows a in the figure, some nozzles are controlled not to eject ink droplets. When #1 nozzle passes through printing area C, the control is cleared.

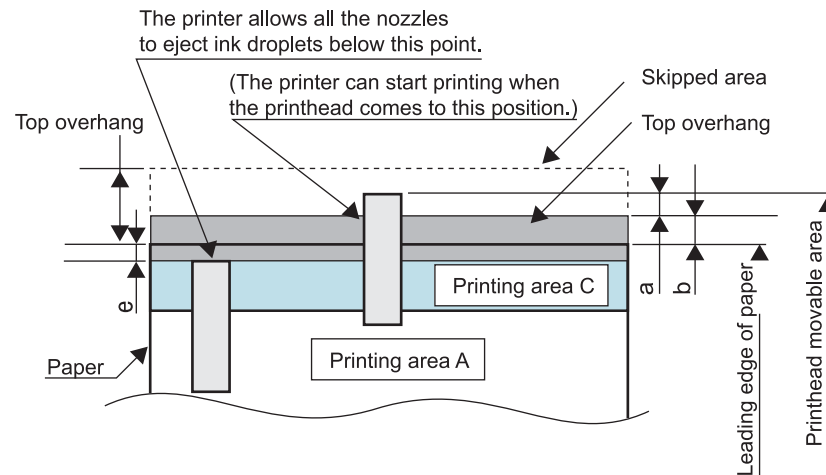

Figure 1-6. Printhead Movable Area (0-mm Top Margin)

Details on the length that the printhead moves off the paper edges (a), printing area off the paper edges (b), and points where the nozzle control is cleared (e) are shown in the table below.

	4x6 (Hi-speed)	4x6	A4/Letter or smaller	A3+ or smaller
a	68/360" (4.80 mm/0.19 in.)	68/360" (4.80 mm/0.19 in.)	68/360" (4.80 mm/0.19 in.)	68/360" (4.80 mm/0.19 in.)
b	13/360" (0.92 mm/0.04 in.)	9/360" (0.64 mm/0.03 in.)	9/360" (0.64 mm/0.03 in.)	9/360" (0.64 mm/0.03 in.)
e	-55/360" (-3.88 mm/-0.15 in.)	-50/360" (-3.52 mm/-0.14 in.)	-46/360" (-3.25 mm/-0.13 in.)	-38/360" (-2.68 mm/-0.1 in.)

Note : As for e values, areas off the paper edges are indicated by negative values.
 Nozzle positions for printing off the paper edge: #1 to #18 (18 nozzles in total)
 Nozzle pitch for printing off the paper edge: 68/360 (4.80mm)

□ Bottom edge

- (1) When bottom margin is set to 20 mm (0.79 in.)
(For envelope/when bottom margin is set automatically)

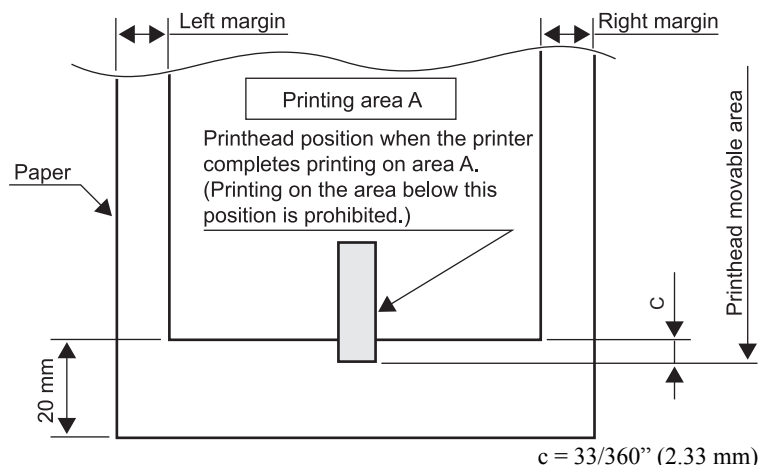

For reference: C= 20 mm - (length from upstream nozzle position to nip position + its variations (simple addition) + variations in the bottom area accumulated from the top)

Figure 1-7. Printhead Movable Area (20-mm Bottom Margin)

- (2) When bottom margin is set to 3 to 20 mm (0.12 to 0.79 in.)

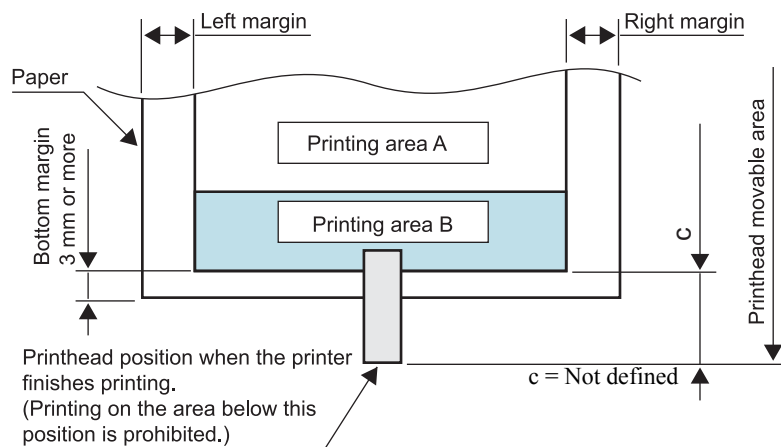

Figure 1-8. Printhead Movable Area (3-mm Bottom Margin)

- (3) When bottom margin is set to 0 mm
During printing the area indicated by the arrows c in the figure, some nozzles are controlled not to eject ink droplets.

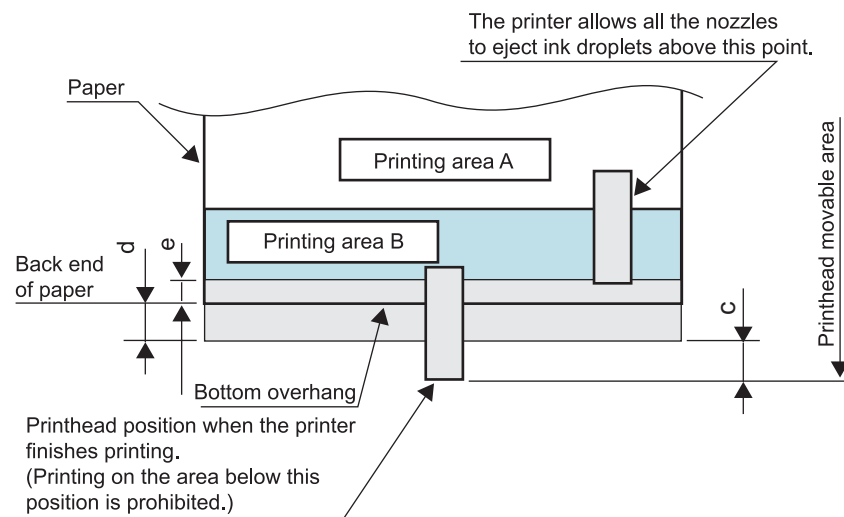

Figure 1-9. Printhead Movable Area (0-mm bottom margin)

Details on the length that the printhead moves off the paper edges (a), printing area off the paper edges (b), and points where the nozzle control is cleared (e) are shown in the table below.

	4x6 (Hi-speed)	4x6	A4/Letter or smaller	A3+ or smaller
a	68/360" (4.80 mm/0.19 in.)	68/360" (4.80 mm/0.19 in.)	68/360" (4.80 mm/0.19 in.)	68/360" (4.80 mm/0.19 in.)
b	27/360" (1.91 mm/0.07 in.)	30/360" (2.12 mm/0.08 in.)	39/360" (2.75 mm/0.10 in.)	55/360" (3.88 mm/0.16 in.)
e	-41/360" (-2.89 mm/-0.11 in.)	-44/360" (-3.10 mm/-0.12 in.)	-38/360" (-2.68 mm/-0.1 in.)	-28/360" (-1.98 mm/-0.08 in.)

Note : As for e values, areas off the paper edges are indicated by negative values.
Nozzle positions for printing off the paper edge: #73 to #90 (18 nozzles in total)
Nozzle pitch for printing off the paper edge: 68/360 (4.80mm)

1.2.1.1 Printing Area (CD-R)



Stylus Photo 1390 does not support direct print on CD-R/DVD-R.

Printing Area

Figure 1-10 shows the printing area for CD-R. Outer and inner limit of printing area is $\phi 120$ and $\phi 18$, respectively. The process of determining the reference point and defining the printing area is described below.

- (1) The reference point in main-scanning direction is 72 mm off from the center of the CD-R (toward the home position side). The center of the CD-R is detected automatically.
- (2) The reference point in paper-feed direction is 67.5 mm off from the center of the CD-R (toward the downstream side).
- (3) User can change the center position of the CD-R in the range of \pm CDX mm (main-scanning direction) and \pm CDY mm (paper-feed direction).

Unit	Amount of the Nozzles Off the Paper Edges		Adjustable Range of the CD-R Center Position	
	a (Top)	c (Bottom)	CDX (X direction)	CDY (Y direction)
inch	358/360	359/360	$\pm 14/180$	$\pm 28/360$
mm	25.26	25.33	± 2	± 2

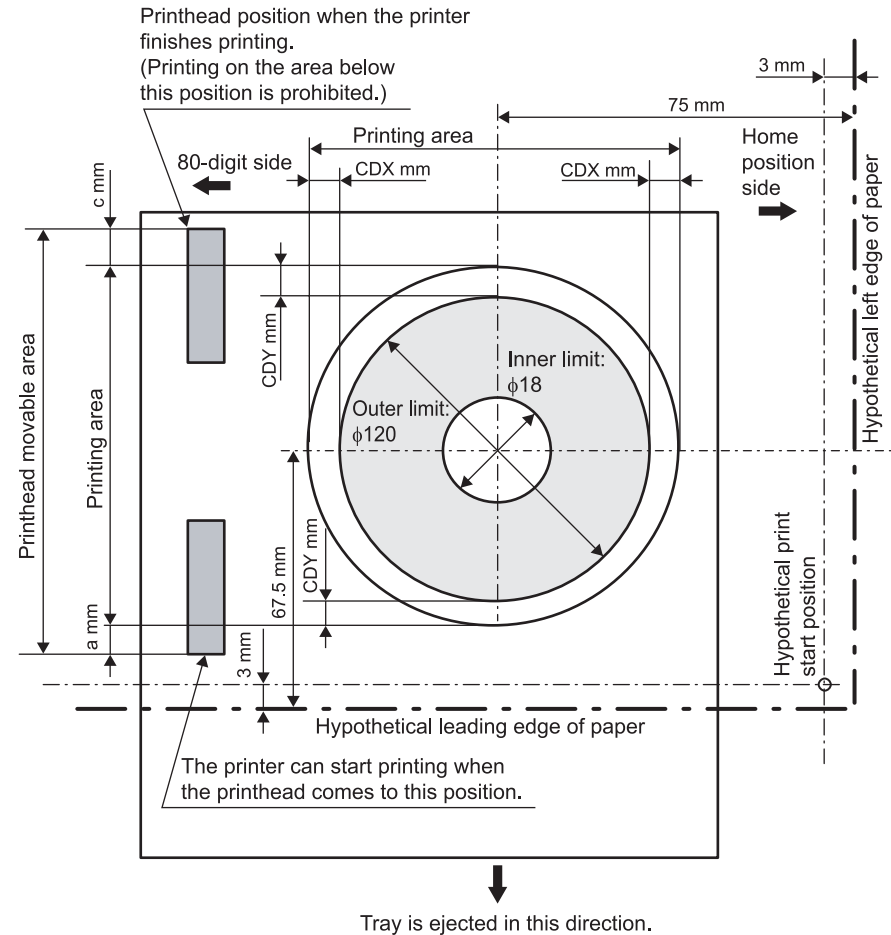

Figure 1-10. Printing Area (CD-R)

1.3 PG Setting

EPSON Stylus Photo 1390/1400/1410 features an Auto Platen Gap (APG) adjuster that sets the platen gap to suit the type of paper being used, and this prevents paper misalignment and jamming that can cause problems during operation.

Table 1-4 shows the relationship among PG positions, media, and sensors.

Table 1-4. PG Setting

	PG Position					
	PG (--)	PG (-)	PG (Typ)	PG (+)	PG (++)	Release
Printing	• Some special paper	• Special paper	• Plain paper • PG (-) rubbing prevention	• Envelope • PG (Typ) rubbing prevention	• CD-R*1	---
Not printing	---	---	• Standing-by after power-on (Output tray is lowered) • At power-off	---	• Initialization at power-on • Cleaning (wiping) • Replacing ink cartridge(s)	• Waiting for CD-R to be fed*1 • Removing jammed paper
PG value	1.05 mm (0.041 inch)	1.2 mm (0.047 inch)	1.7 mm (0.06 inch)	2.1 mm (0.08 inch)	4.5 mm (0.17 inch)	---
Sensor	PG (--)	PG (-)	PG (Typ)	PG (+)	PG (++)	Release
APG sensor 1*2	H	H	H	H	H	H
APG sensor 2	L	L	L	L	H	H

Note *1: Stylus Photo 1390 does not support direct print on CD-R/DVD-R.

*2: APG sensor 1 outputs L between each PG position.

1.4 Printer Function

1.4.1 Operator Controls

The control panel is shown in the figure below.

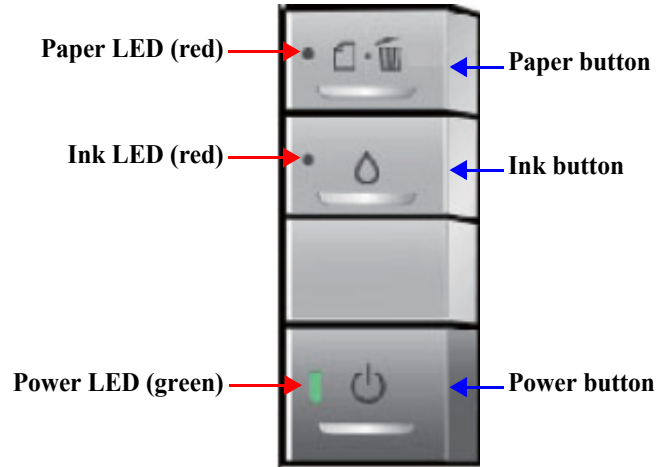

Figure 1-11. Operator Controls

1.4.2 Buttons

- Power button
- Paper button
- Ink button

1.4.3 LED Indicators

- Power LED: Green
- Paper LED: Red
- Ink LED: Red

1.4.4 Panel Functions

Table 1-5. Normal Panel Functions

Button	Function
Power	<ul style="list-style-type: none"> • Turns on/off the power.
Paper	<ul style="list-style-type: none"> • Loads or ejects the paper (Invalid when the CD-R guide is opened.*1) • Clears double feed error and resumes printing. • Cancels the current print job during printing. • Clears paper out error and resumes printing. • Clears paper jam error, ejects the paper, and resumes printing. • When ink end (any cartridge) error occurs, the ink cartridge holder moves to the ink replacement position. • The ink cartridge holder returns to the home position from the ink replacement position.
Ink	<ul style="list-style-type: none"> • The ink cartridge holder moves to the ink replacement position. • When ink low, ink end, or no ink cartridge error occurs, the ink cartridge holder moves to the ink check position. • When the ink cartridge holder is in the ink check position, the holder moves to check another cartridge of different color, or the holder moves to the ink replacement position. • The ink cartridge holder returns to the home position from the ink replacement position.
Ink (When pushed and held for 3 seconds)	<ul style="list-style-type: none"> • Starts printhead cleaning • When ink low, ink end, or no ink cartridge error occurs, ink replacement sequence starts.
CD-R guide (When opened)	<ul style="list-style-type: none"> • Clears CD-R guide error.*2

Note *1: Stylus Photo 1390 does not support direct print on CD-R/DVD-R.

*2: CD-R guide error occurs when the CD-R guide is opened during printing, or when the printer receives a print job for cut-sheet with the CD-R guide opened. (This is not applied to Stylus Photo 1390.)

Power-on functions

Table 1-6. Panel Function during Power-on

Button Held during Power-on	Function
Paper	Starts status printings.
Ink	Starts in rubbing reduction mode.

Power-off function

Table 1-7. Panel Function during Power-off

Button Held during Power-off	Function
Ink	Forced power-off.

Note : Press the power button first. Making sure the power button is not pressed down, push and hold the ink button for 7 seconds.

CD-R printing



Stylus Photo 1390 does not support direct print on CD-R/DVD-R.

Table 1-8. Panel Function during Printing on CD-R

Button	CD/DVD Tray	Function.
Paper	Inserted	<ul style="list-style-type: none"> Clears CD/DVD tray error. Cancels the current print job during printing.
	Not inserted	Clears CD/DVD tray error
Ink	Inserted	Same as normal panel functions (including the functions when the button is pushed and held for 3 seconds).
	Not inserted	

1.4.5 Printer Condition and Panel LED Status

Table 1-9. Panel Status

Printer Status	Button LEDs			Priority
	Power	Paper	Ink	
Power ON (Ready) condition	On	---	---	12
Camera being connected (No rubbing reduction)*1	Blink2	---	---	12
Camera being connected (Rubbing reduction)*1	Blink4	---	---	12
Ink low	---	---	Blink	11
Unsupported device connection error*1	---	Blink2	Blink3	10
Data processing	Blink	---	---	10
Loading/Ejecting paper	Blink	---	---	10
No ink cartridge or Ink end	---	---	On	9
CSIC error	---	---	On	9
Processing ink sequence	Blink	---	---	8
Ink cartridge change mode	Blink	---	---	7
CD/DVD tray error*1	---	On	---	6
Paper out	---	On	---	6
Double feed	---	On	---	6
Paper (CD-R) jam*1	---	Blink	---	5
CD-R guide error*1	---	Blink2	Hi-speed Blink	4
Maintenance request	Off	Alt Blink	Alt Blink	3
Fatal error	Off	Hi-speed Blink	Hi-speed Blink	2
Powering OFF	Hi-speed Blink	Off	Off	1
Reset request*2	All the LEDs turn on for 0.2 seconds.			---

Note *1: Do not apply to Stylus Photo 1390.

*2: All the LEDs turn on for 0.2 seconds.

Note : ---: No change to LED.
 Blink: 0.5 seconds on, 0.5 seconds off (repeat)
 Blink2: 0.2 seconds on, 0.2 seconds off, 0.2 seconds on, 0.4 seconds off (repeat)
 Blink3: 0.2 seconds off, 0.2 seconds on, 0.2 seconds off, 0.4 seconds on (repeat)
 Blink4: 0.8 seconds on, 0.2 seconds off
 Hi-speed Blink: 0.1 seconds on, 0.1 seconds off (repeat)
 Alt Blink: Continuous alternating blink of Paper and Ink LEDs.

1.4.6 Errors

Table 1-10. Errors

Error Status	Occurrence Condition	Remedy	
		Stylus Photo 1390	Stylus Photo 1400/1410
Ink end	The cartridge has almost run out of ink.	Carry out the ink cartridge replacement operation.	
		Press the Ink button.	Remove the CD/DVD tray and then press the Ink button.
Paper out	The printer failed to load a sheet of paper.	Load a paper in the ASF, and press the Paper button to feed the paper.	
		---	Set the CD-R guide lever to the ASF position and then press the Paper button.
Paper jam	1. The printer failed to eject the remaining paper at power-on. 2. An FF command or a press of the Paper button could not eject the paper. 3. The printer failed to eject the CD/DVD tray.* 4. The printer prints on a 58 mm (23 in.) or shorter length of paper.	1. ASF mode Remove the jammed paper and press the Paper button.	1. ASF mode Remove the jammed paper and set the CD-R guide lever to the ASF position. Then press the Paper button.
		2. CD-R mode Remove the jammed CD/DVD tray and press the Paper button.	
Double feed error	The printer has detected that multiple sheets have been fed simultaneously.	Press the Paper button to eject the paper.	
		---	Set the CD-R guide lever to the ASF position and then press the Paper button.
No ink cartridge Ink cartridge error	1. The printer detects at least one ink cartridge is missing. 2. The printer cannot communicate with the CSIC chip on one of the cartridges.	Make sure genuine EPSON ink cartridges are installed.	
		---	Remove the CD/DVD tray and then press the Ink button.
Maintenance request	The total amount of waste ink used for cleaning and flushing has reached the upper limit.	Replace the waste ink pad and reset the Waste Ink Counter.	
Fatal error	The printer cannot control error.	Turn the power off and on again.	
CD-R guide error	1. The printer received a print job for cut-sheet when the CD-R guide lever is set to the CD-R position. 2. The CD-R guide lever is set to the CD-R position during ASF printing.	N/A	Set the CD-R guide lever to the ASF position.
	1. The printer received a print job for CD-R media when the CD-R guide lever is set to the ASF position.	N/A	Set the CD-R guide lever to the CD-R position.
CD/DVD tray error	CD/DVD tray is not inserted.	N/A	Insert a CD/DVD tray and press the Paper button.
Unsupported device connection error	Unsupported device is connected.	N/A	Disconnect the device from the USB connector.

Note *: Does not apply to Stylus Photo 1390.

1.5 Size and Weight

Dimensions

- Storage: 615 mm (24.2 in.) W x 314 mm (12.4 in.) D x 223 mm (8.8 in.) H
- Printing: 615 mm (24.2 in.) W x 803 mm (31.6 in.) D x 413 mm (16.3 in.) H

Weight

- 11.5 Kg (25.4 lbs.)

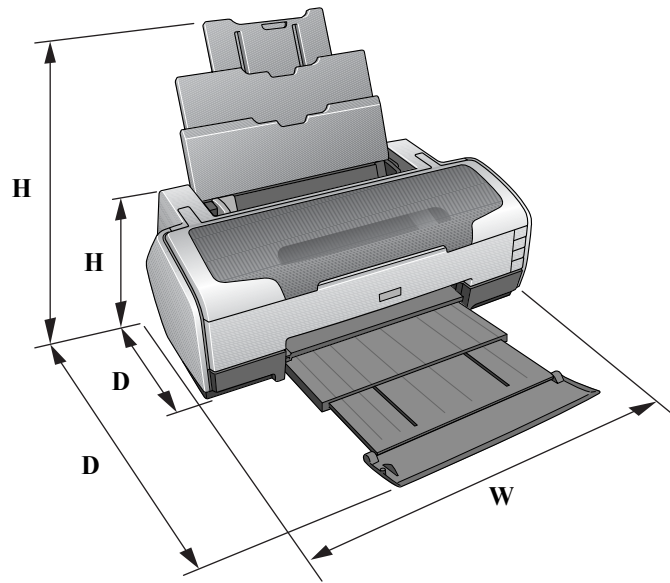

Figure 1-12. Physical Dimensions

1.6 Accessories

Standard accessories

- User's guide
- Ink cartridge (one for each of the six colors)
- Software CD-ROM
- Setup sheet
- On-line questionnaire sheet
- Customer Satisfaction Card (information card)
- Guarantee card
- CD/DVD print kit (Stylus Photo 1390 does not support CD-R/DVD-R print.)
 - CD/DVD tray
 - Small CD insert

Consumable and optional supplies

- Ink cartridge

Color	Stylus Photo 1390	Stylus Photo 1400	Stylus Photo 1410
Black	T0851	T0791	T0811
Cyan	T0852	T0792	T0812
Magenta	T0853	T0793	T0813
Yellow	T0854	T0794	T0814
Light Cyan	T0855	T0795	T0815
Light Magenta	T0856	T0796	T0816

- Network Print Server

CHAPTER

2

OPERATING PRINCIPLES

2.1 Overview

This chapter explains the operating principles of the mechanical sections and electrical circuits in this product. The main components of this product are as follows.

- Control Circuit Board : C655 MAIN
- Power Supply Circuit Board : C589 PSB
- Control Panel Board : C589 PNL
- Head Circuit Board : C653 HEAD

2.2 Printer Mechanism

In common with previous model, this printer uses DC motors and stepping motors as power source. The following table describes the motor types and their applications.

Table 2-1. Motors

Motor Name	Type	Applications/Functions
CR Motor	DC motor with brushes	Drives the Carriage. Makes very little driving noise. Controlled by the CR linear scale and CR encoder sensor.
PF Motor	DC motor with brushes	Drives the paper feed roller for the fixed-value paper loading or the paper feed/eject operation. To grasp the paper feed pitch, the precision gear surface is fitted with the PF Scale and the PF Encoder Sensor is used to control the motor.
APG Motor	DC motor with brushes	Drives the Carriage Unit at the time of PG setting. The two APG Sensors and Carriage Shaft are driven vertically to control the motor.
ASF Motor	4-phase, 48-pole PM type stepping motor	Drives the paper feed operation of the ASF. Since this is a stepping motor, no scales or photo sensors are required to grasp the driving conditions.
Pump Motor	4-phase, 48-pole PM type stepping motor	Drives the pump, wiper, etc. of the Ink System. Since this is a stepping motor, no scales or photo sensors are required to grasp the driving conditions.

The basic mechanism is the same as the Stylus Photo R1800.

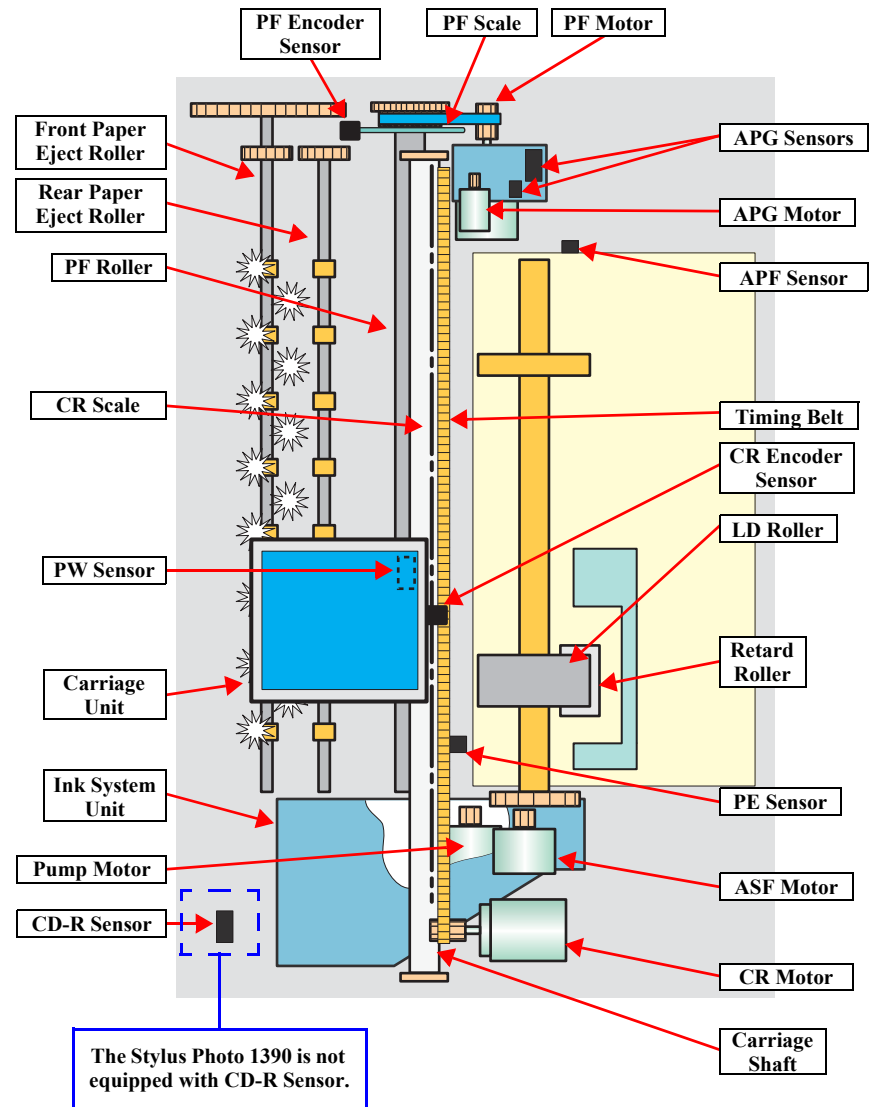

Figure 2-1. Printer Mechanism Outline

2.2.1 Carriage Mechanism

The Carriage mechanism consists of parts/units such as the Carriage Motor (CR Motor), Carriage Shafts, Platen Gap Adjustment Mechanism and Carriage Lock Mechanism.

2.2.1.1 Carriage Mechanism

The following indicates the specifications of the CR motor (DC motor) that drives the Carriage.

Table 2-2. CR Motor Specifications

Item	Specifications
Type	DC motor with brushes
Drive voltage	+42V \pm 5% (voltage applied to driver)
Armature resistance	23.6 Ω \pm 10%
Inductance	17.5mH \pm 25%
Drive method	PWM, constant-current chopping
Drive IC	A6628

Closed loop control based on the CR Motor (DC Motor) and CR Encoder Sensor has advantages in stabilized print quality and silent operation.

- Heat Generation Control
The printer has a mechanism to reduce the variations in the torque constant and coil resistance of the DC motors, and variations in output voltage of the Power Supply Board to obtain a designated heating value.
- CR Variation Measurement Sequence
The variations mentioned above are measured in a CR variation measurement sequence when the CR mechanical load is in the initial status and saved into the EEPROM. According to the saved information, the printer controls the drive voltage to obtain a designated driving current. This minimizes the unit-to-unit variation.

- CR Measurement Sequence
To set the appropriate drive current value according to the CR mechanical load, the mechanical load is measured in a CR measurement sequence and saved into the EEPROM at power-on or after replacing the Ink Cartridge(s).

The above control and sequences correct the drive current value of the CR Motor according to not only the mechanical load but also the variations of the motors. In addition, the resultant CR drive current value is used to calculate a heating value, and when the specified heating value is reached, wait time is provided per CR path for printing.

2.2.1.2 Carriage Home Position Detection

As in the previous model, the Carriage Home Position is detected using the drive current of the CR Motor and the speed/position signal of the CR Linear Encoder. The basic home position detection sequence is described below.

1. The CR linear encoder pulse counter in the CPU is reset by the initialization operation performed at power-on.
2. When the CR Motor rotates counterclockwise, the Carriage Unit moves from left to right. When the following conditions are satisfied, the CPU assumes that the Carriage Unit made contact with the right frame.
 - The ASIC detects 935/1500 counts or more in the PWM output under CR Motor load positioning control.
 - P1 (number of output pulses from when the power is switched on till the Carriage Unit makes contact with the right frame) is 19 steps or less.
3. When the CR Motor rotates clockwise, the Carriage Unit moves from right to left. When the following conditions are satisfied, the CPU assumes that the Carriage Unit reached the CR lock confirmation position.
 - The ASIC detects 600/1500 counts or more in the PWM output under CR Motor load positioning control.
 - A difference between P1 and P2 (number of output pulses from when the Carriage Unit made contact with the right frame until it reaches the Carriage lock confirmation position) is 19 steps or less.
4. When the CR Motor rotates counterclockwise to move the Carriage from left to right and the CPU detects 935/1500 counts or more in the PWM output under CR Motor load positioning control, the printer judges that the Carriage has moved to the far right position (in contact with the right frame).
5. When a difference between P1 and P3 (number of output pulses from when the Carriage Unit reached the Carriage lock confirmation position until it makes contact with the right frame) is 4 steps or less, the printer judges that the Carriage Unit is in the home position.

IC9 (CPU-ASIC) sets the drive current value adequate for the Carriage Unit motion and outputs it to the motor driver.

Based on the signal output from IC9 (CPU-ASIC), IC11 (Motor Driver) outputs the CR Motor drive current to the CR Motor.

2.2.1.3 Sequence Used for PW Detection

The PW (paper width) Sensor installed on the bottom of the Carriage Unit is used to control the printer according to various sequences.

The following briefly describes the operating principle of the PW Sensor.

A dark voltage is measured by the PW Sensor in three places at the right flat area (area without the absorber) on the Front Paper Guide every time the printer is turned on, and the measurement values are saved into the EEPROM as threshold values.

- Threshold value $>$ detection voltage: Paper present
- Threshold value $<$ detection voltage: Paper absent

The following sequences are performed.

- Detection of Left and Right Edges of Paper Control
 - Before Printing
The printer sets the print range according to the paper-size information from the Driver and the actual paper-size detected by the PW sensor.
 - During Printing
When executing a borderless printing, the printer sets the off-range margins by detecting the paper edges with the PW Sensor. When the resolution is 1440 x 1440 (VSD3) or 2880 x 1440 (VSD3) dpi, the printer performs the Off-Range Thinning Out Control to make a further correction to the off-range margins.
- Detection of Top Edge of Paper Control
Before starting a print job, the printer detects the top edge of a loaded single sheet of paper to set the off-range top margin. (Only when not detecting the top edge of paper with the PW Sensor.)
- Detection of Bottom Edge of Paper Control
After starting a borderless printing, the printer sets the off-range bottom margin.
- Detection of Edges of CD-R Control
(The Stylus Photo 1390 is not equipped with CD/DVD related units.)
Before starting to print, the PW Sensor detects top, bottom, left and right edges of the CD-R. *See Section 2.2.3.3 CD-R Printing Mechanism on page 29.*

- Detection of CD/DVD Tray Control
(The Stylus Photo 1390 is not equipped with CD/DVD related units.)
Before starting to print, determines the type of media.
 - PW sensor dark voltage (VH) measurement
PW sensor dark voltage (VH) measurement is performed at the following timings and locations and used to calculate the threshold value of whether paper is present or not.
 - CD/DVD Tray
(The Stylus Photo 1390 is not equipped with CD/DVD related units.)
When printing on a CD-R, the dark voltage is measured on the CD/DVD tray, and the threshold value (VS) is then calculated and saved in the EEPROM area as a PW detection level.
 - Threshold value > detection voltage: CD-R present
(tray home position detected)
- The measurement voltage in the presence of the CD-R is saved into the EEPROM as a white level. The white level value is used to check the sensor deterioration condition on occasions such as servicing.
- If the measurement value of the white level is close to that of the PW detection level, it means that the sensor is dirty or deteriorated.

2.2.1.4 APG (Auto Platen Gap) Adjustment Mechanism

The following indicates the specification of the DC motor that drives the APG adjuster.

Table 2-3. APG Motor Specifications

Item	Specifications
Type	DC motor with brushes
Drive voltage	+42V ± 5% (voltage applied to driver)
Armature resistance	64.7Ω ± 15%
Inductance	37.6mH ± 25%
Rotor Inertia	3.94gcm ²
Drive method	PWM, constant-current chopping
Drive IC	A6628

The APG Motor (DC Motor) and two APG Sensors drive the PG Cam to automatically adjust the PG amount according to the paper.

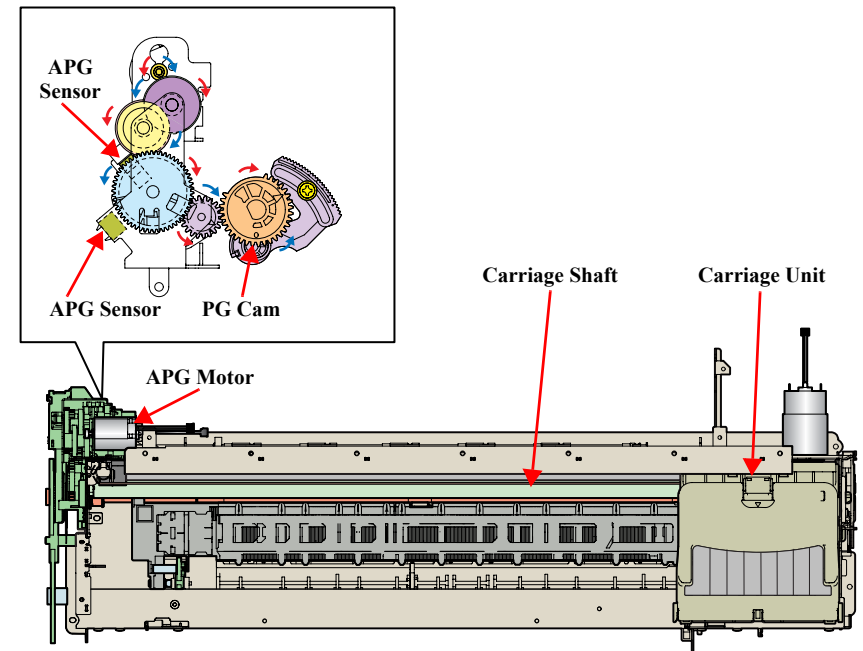

Figure 2-2. APG Mechanism

2.2.2 Printhead Specifications

The Printhead of this product is a F3-Mach head. The following shows the arrangement of the nozzles and the color arrangement of each nozzle line when viewing the Printhead from behind.

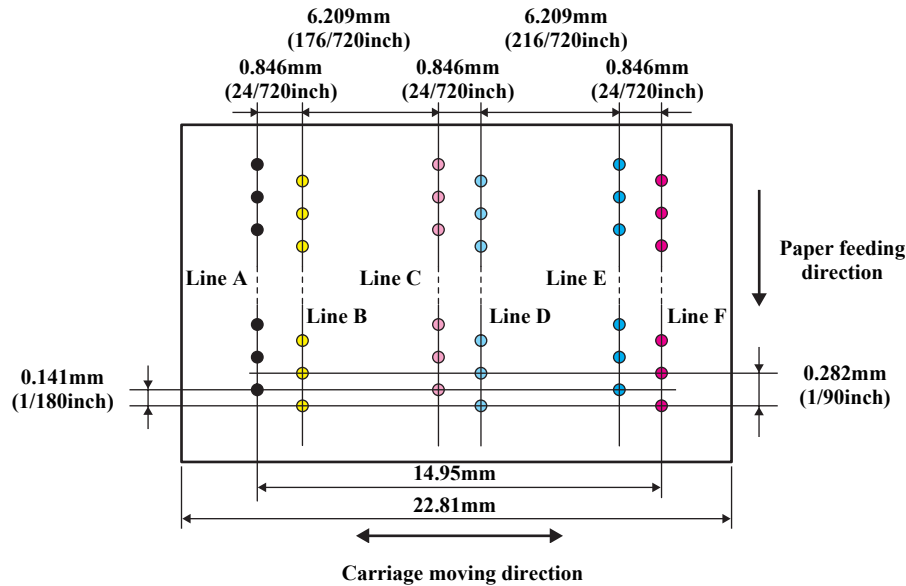

Figure 2-3. Nozzle Arrangement

Table 2-4. Nozzle Lines and the Corresponding Ink Color

Line	Ink
A	Black
B	Yellow
C	Light-Magenta
D	Light-Cyan
E	Cyan
F	Magenta

2.2.3 Paper Feeding Mechanism

The paper feeding mechanism is a mechanism that feeds paper or CD/DVD tray to the PF Roller Shaft. (The Stylus Photo 1390 is not equipped with CD/DVD related units.)

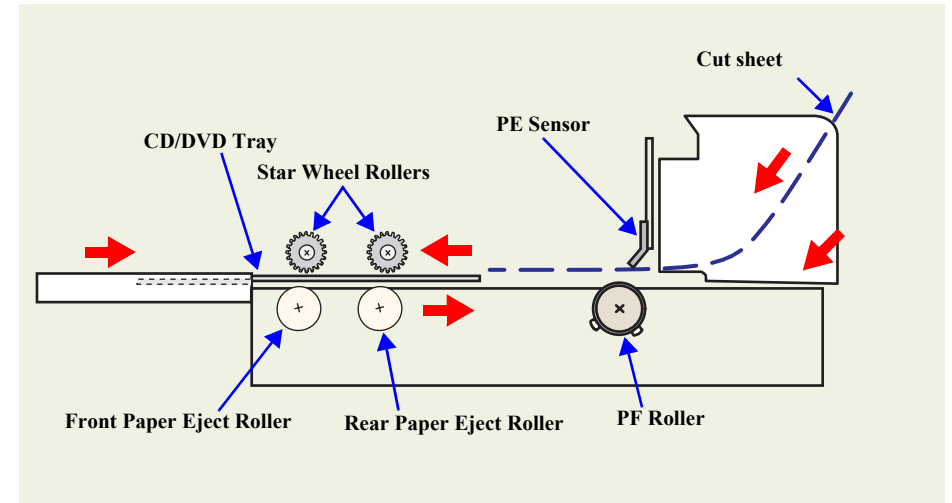

Figure 2-4. Paper Feeding Mechanism

2.2.3.1 ASF Paper Feeding Mechanism

The following shows the specifications of the stepping motor that drives the ASF Assy.

Table 2-5. ASF Motor Specifications

Item	Specifications
Type	4-phase, 48-pole PM type stepping motor
Drive voltage	+42V ± 5% (voltage applied to driver)
Winding resistance	7.0Ω ± 10% (per phase at 25°C)
Inductance	10.2mH ± 20% (1kHz, 1Vrms, at 25°C)
Drive method	Bipolar drive/constant-current drive
Drive IC	A6628

Driven by the ASF Motor, the ASF Assy performs the following feeding operation.

1. When a paper feeding command is issued from the PC or the Paper button of the panel is pressed after power-on, the driving force of the ASF Motor begins to be transmitted to the LD Roller following the route shown below.

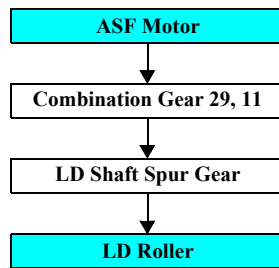

2. When the LD Roller starts rotating, the flag of the ASF Sensor Wheel comes free from the notch on the ASF Sensor. At the same time, the Paper Back Lever becomes free from the Cams located at the left and right ends of the LD Roller, then the Paper Holder on the Paper Back Lever inclines downward by tensile force of the Paper Back Lever Torsion Spring.
3. By the LD Roller's rotation, the Hopper is released from the Hopper Cams located on the left and right ends of the LD Roller, and the Hopper pops up by tensile force of the Hopper Compression Spring.

4. When the next sheet of paper is fed by the LD Roller and the Retard Roller, the Hopper is pressed against the Frame again by the Hopper Cams, and the Paper Holder of the Paper Back Lever rises by the Cams on the left and right ends of the LD Roller to prevent the next sheet from being fed with the previous sheet.
5. The LD Roller stops to rotate when it makes one revolution and the flag of the ASF Sensor Wheel returns to the ASF Sensor.

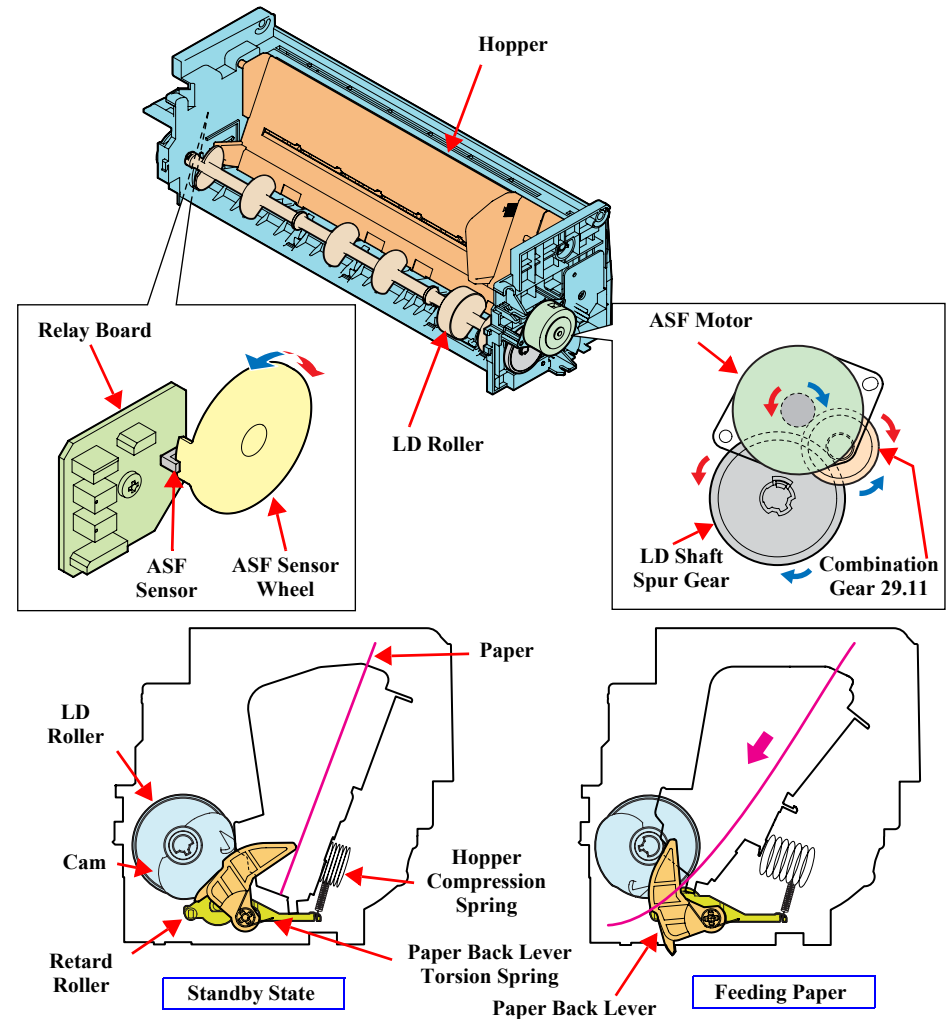

Figure 2-5. ASF Paper Feeding Mechanism

2.2.3.2 CD/DVD Tray Base Lock Mechanism

CHECK
POINT



The Stylus Photo 1390 is not equipped with CD/DVD related units.

To prevent the Printhead from being damaged by mistake, the printer is designed to lock the CD/DVD Tray Base when the Carriage Unit is out of its home position.

The following explains the lock mechanism of the CD/DVD Tray Base.

□ Lock Release Sequence

1. When the Carriage Unit returns to its home position, the Pump Motor drive is transmitted to the Paper EJ Lock Release Cam.
2. The salient of the Cam presses down the Paper EJ Transmission Lock Lever to release the tab of the Paper EJ Lock Lever from the Paper EJ Transmission Lock Lever.
3. The CD-R Release Lever comes free from the Paper EJ Lock Lever and comes down to enable the CD/DVD Tray Base to open.

When the Carriage Unit is out of its home position, the salient of the Paper EJ Lock Release Cam does not press down the Paper EJ Transmission Lock Lever, and the tab of the Paper EJ Lock Lever is not released. Therefore, the CD/DVD Tray Base cannot be opened.

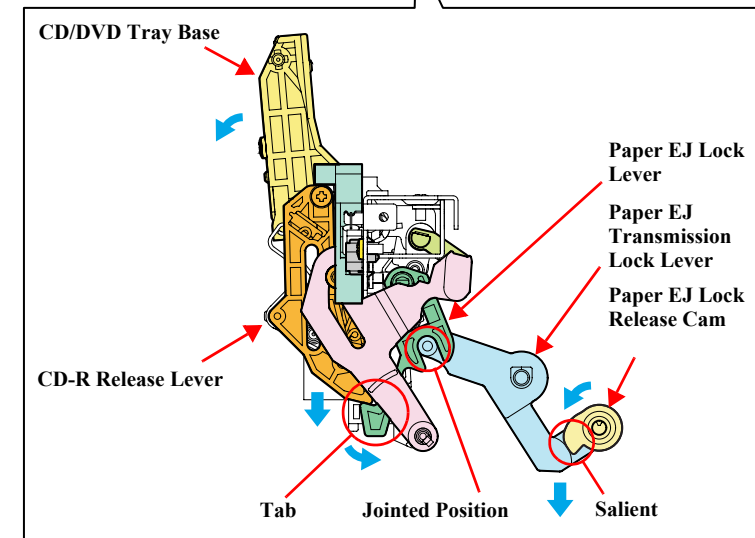
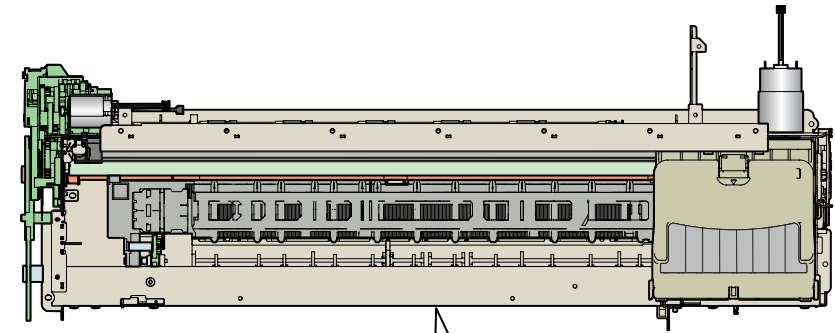

Figure 2-6. CD/DVD Tray Base Lock Mechanism

2.2.3.3 CD-R Printing Mechanism

CHECK
POINT



The Stylus Photo 1390 is not equipped with CD/DVD related units.

□ CD/DVD Tray Home Position Detection Sequence

The following sequence is performed after opening the Front Cover (CD-R Sensor: closed), inserting the CD/DVD Tray to the specified position, and pressing the Paper button.

When the close signal of the CD-R Sensor is detected, no paper is fed from the ASF even if the Paper button is pressed. In this case, pressing the Paper button executes a CD/DVD Tray home position detection sequence.

1. When the APG Assy is driven, the PG position is set to “++” and the Driven Roller of the Upper Paper Guide presses onto the CD/DVD Tray.
2. When the Carriage Unit moves to the left and the PW Sensor detects the CD-R, the Carriage Unit returns to its home position (HP).
3. After waiting for about 5 seconds at the HP, the Carriage Unit moves to the CD/DVD Tray HP detectable position (right end of the CD/DVD Tray).
4. The CD/DVD Tray is pulled towards the ASF, the PW Sensor detects the CD/DVD Tray HP, and then the Carriage Unit moves to the center of the CD/DVD Tray.
5. When the PW Sensor detects the white marking in the center of the CD/DVD Tray, the CD/DVD Tray is fed in the paper ejection direction.
6. The Carriage Unit moves to the left, the PW Sensor detects the white marking on the left, then the Carriage Unit moves to the right, and the PW Sensor detects the white marking on the right.
7. The Carriage Unit moves to the center of the CD/DVD Tray, and the PW Sensor starts detection of the front and back direction of the CD-R. After the front end of the CD-R is detected, the CD/DVD Tray is fed towards the paper ejection direction, and the back end of the CD-R is detected. After that, the CD/DVD Tray is fed to the center of the CD-R in the paper ejection direction.
8. The Carriage Unit moves to the left, and the PW Sensor starts detection in the horizontal direction of the CD-R. After the left end of the CD-R is detected, the Carriage Unit moves to the right, and the right end of the CD-R is detected.

9. The Carriage Unit stops after moving to the CD/DVD Tray HP detectable position, then the CD/DVD Tray is fed towards the ASF.
10. When the CD/DVD Tray stops operating, the Carriage Unit moves to the carriage HP and stands by.

If the CD/DVD Tray HP, the white marking, or the CD-R cannot be detected within the steps predetermined for the CD/DVD Tray HP detection sequence, the CD/DVD Tray is ejected and Paper Out Error is displayed.

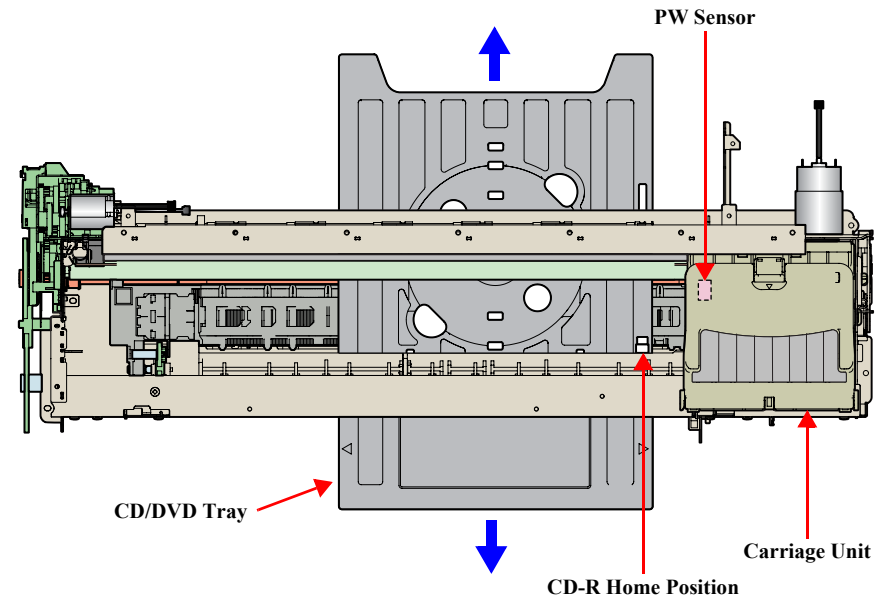

Figure 2-7. CD-R Printing Mechanism

2.2.4 Paper Feeding Mechanism

The Paper Feeding Mechanism is designed to transfer the paper fed from the ASF, or the CD-R fed from the CD/DVD Tray according to the print data. (The Stylus Photo 1390 is not equipped with CD/DVD related units.)

2.2.4.1 Paper Feeding Mechanism

The following shows the specifications of the DC motor that drives the Paper Feeding Mechanism.

Table 2-6. PF Motor Specifications

Item	Specifications
Type	DC motor with brushes
Drive voltage	+42V ± 5% (voltage applied to driver)
Armature resistance	21.2Ω ± 10%
Inductance	17.2mH (1kHz)
Rotor Inertia	18.8gcm ²
Drive method	PWM
Drive IC	A6628

Like the CR Motor, a DC motor is used as the PF Motor in this product. Closed loop control based on the DC Motor and Rotary Encoder has the following advantages.

- Improved paper feed accuracy
- Paper feed amount control

The PF Motor drive is transmitted to the PF Roller and the Paper EJ Roller following the route shown below.

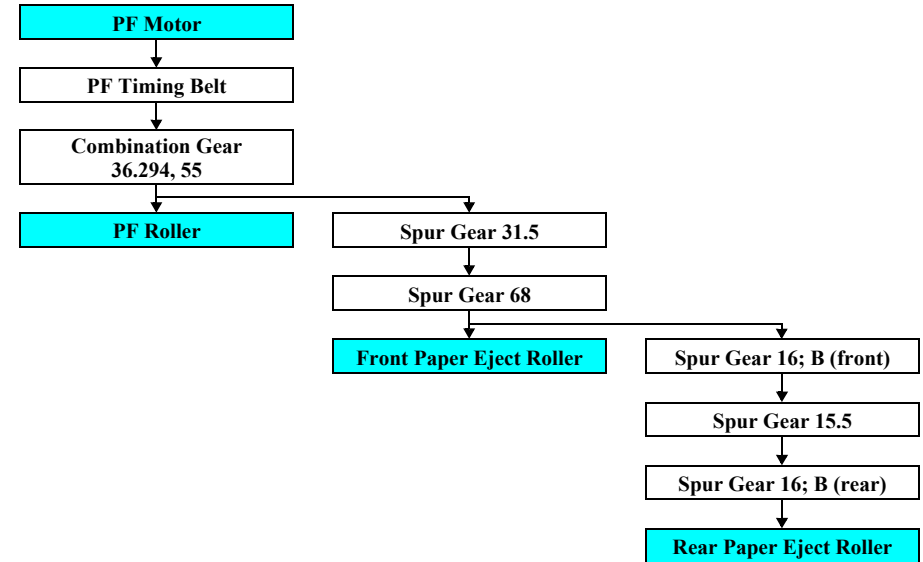

The following shows the part names and outline of the drive transmission path.

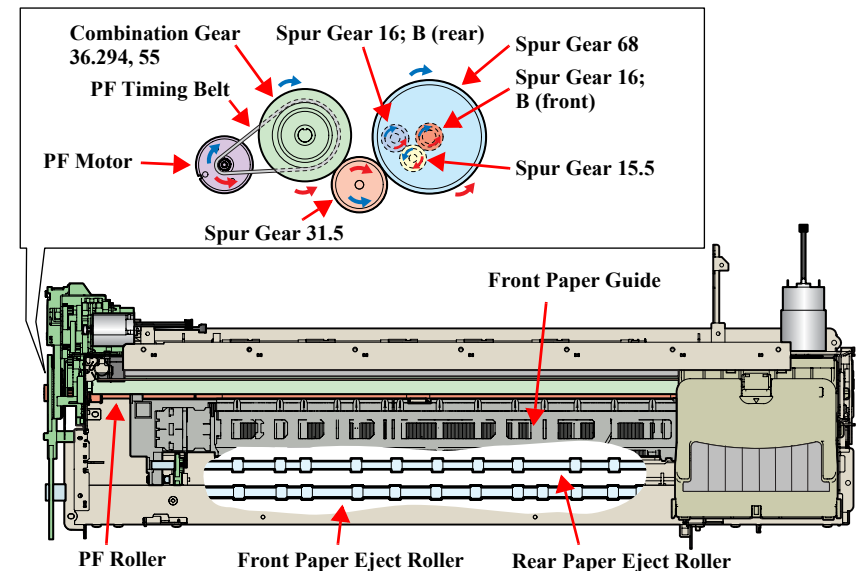

Figure 2-8. Paper Feeding Mechanism

The fed paper is detected by the PE Sensor, and its front end is then transferred to the front of the Front Paper Guide.

To eliminate the deflection of the paper, the paper is then returned toward the ASF Assy by the specified number of steps according to the paper feeding mode.

The paper is re-transferred to the specified paper locating position of the Front Paper Guide.

2.2.4.2 PF Measurement Sequence

- The mechanical load in the paper feeding path is measured in the following cases to perform control so that an adequate current value is set according to the mechanical load.
 - When power is switched on
 - When the Ink Cartridge is replaced
- When the mechanical load in the paper feeding path reaches the specified value, Fatal Error is displayed.

2.2.5 Ink System Mechanism

The Ink System Mechanism consists of the following units.

- Pump Unit (including the CR Lock Lever)
- Cap Unit

2.2.5.1 Pump Unit

The Pump Unit is designed to suck ink from the Printhead or Cap Unit. The Cap Unit has a built-in Head Cleaning Wiper.

The following shows the specifications of the stepping motor that drives the Pump Unit.

Table 2-7. Pump Motor Specifications

Item	Specifications
Type	4-phase, 48-pole PM type stepping motor
Drive voltage	+42V ± 5% (voltage applied to driver)
Winding resistance	10.3Ω ± 10% (per phase at 25°C)
Inductance	13.4mH ± 20% (1kHz, 1Vrms)
Drive method	Bipolar drive/constant-current drive
Drive IC	A6628

The following operations are performed when the drive of the Pump Motor is transmitted to the Pump Unit.

Table 2-8. Pump Motor Rotation Directions and Functions

Pump Motor Rotation Direction*	Functions
CW direction	<ul style="list-style-type: none"> • Cap closing • Ink suction • Wiper resetting • CR Lock setting
CCW direction	<ul style="list-style-type: none"> • Cap opening • Pump release • Wiper setting • CR Lock resetting

Note *: The direction (CW or CCW) was determined by viewing the motor from the output shaft of the motor mounting plate.

2.2.5.2 Drive Transmission Path to Pump Unit

The drive of the Pump Motor is transmitted to the Pump Unit in the following path.

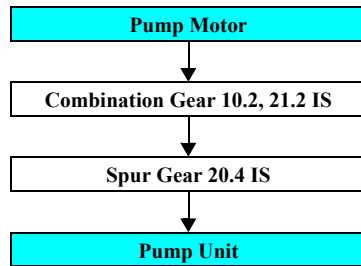

The following shows the internal part names and operation outline of the Pump Unit.

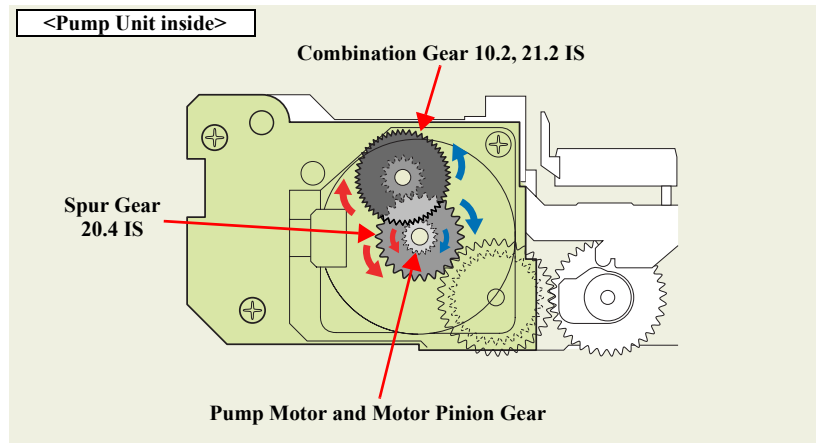

Figure 2-9. Outline of Pump Unit Inside

The following shows the Pump Unit operating principle.

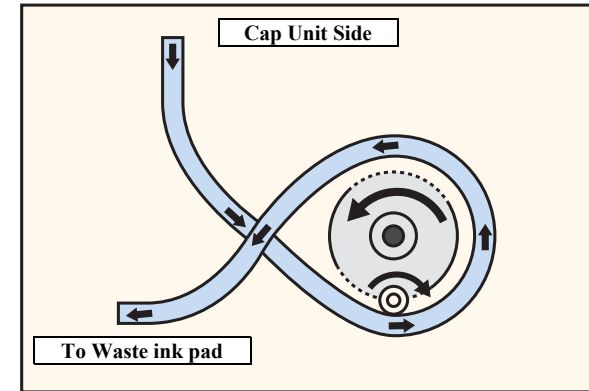

Figure 2-10. Pump Unit Operating Principle

- Ink Suction
 1. The Pinion Gear of the Pump Motor rotates in the CW direction.
 2. The Roller turns and simultaneously presses the tube.
 3. Ink is fed from the Cap Unit toward the Waste Ink Pad.

- Pump Release
 1. The Pinion Gear of the Pump Motor rotates in the CCW direction.
 2. The Roller moves away from the tube and releases the tube.
 3. Ink is not sucked.

2.2.5.3 Cap Unit

The Cap Unit is designed to keep inside of the Cap airtight by the Cap sticking to the Printhead surface with the driving force of the Pump Motor when ink is sucked. When the printer is in a standby status or its power is OFF, the Cap Unit prevents the ink from thickening.

The following figures shows the Cap Unit operation.

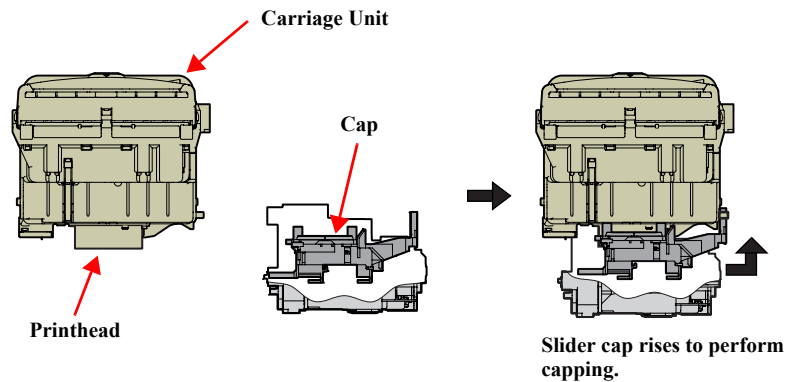

Figure 2-11. Capping Mechanism

2.2.6 Ink Sequence

The following ink sequence is executed according to various timer, counter, flag and other information saved on the EEPROM.

□ Initial Ink Filling

When the printer is powered on for the first time after purchase, the printer executes the initial ink filling operation to fill the ink cavities of the Head with ink. When the initial ink filling operation is performed properly, the printer clears the flag in the EEPROM so that initial ink filling operation will not be performed when it is powered on the next time. The EPSON Stylus Photo 1390/1400/1410 requires about 170 seconds to perform the initial ink filling operation.

If the sequence does not end normally during initial filling, the initial filling flag is not cleared and the CL operating flag is set. Because of these flags, when powered on the next time, the printer assumes that it was powered off for some reason during initial filling and executes CL3 instead of the initial filling sequence. (On the previous model, initial filling was executed again. However, when this operation was performed, ink was wasted and therefore CL3 is executed to cover for the ink filling performance.)

When the initial filling flag is set and the CL operating flag is not set, the printer judges that the initial filling was not executed at all (power was switched on but the cartridges were not installed), and when the printer is powered on the next time, it executes initial filling.

□ Replacement Cleaning

Replacement cleaning is executed when an Ink Cartridge(s) is replaced.

□ Manual Cleaning

This printer provides three different manual cleanings to remove ink coagulated by air bubbles, viscous material, or foreign matter. Perform the following manual CL operations by operating the panel or using the utility included in the printer driver. Independently of the printing path after the previous CL, perform manual CL from CL1 to CL3 in order if the cumulative printing timer counter is less than 9 minutes. When the cumulative printing timer counter is more than 9 minutes, only CL1 is executed.

■ Wiping Operation

Clean the nozzle surface, with the right-half of the rubber part on the wiper.

■ Flushing Operation

Prevent color mixture. Stabilize the ink surface inside the nozzles.

In addition, the printer determines which CL to perform according to the remaining amount of ink in the Cartridge. When the printer detects the amount is low, it automatically choose the CL that uses ink less than the other CLs. If the remaining amount of ink is extremely low (Ink Low or Ink End status), the printer disables the all the manual cleanings and indicates the status on the STM3.

□ Timer Cleaning

Ink is consumed depending on the combination of the cumulative printing timer, cumulative cleaning count and cleaning timer.

□ Flushing

There are two types of flushing.

■ Flushing before printing

This is performed to reduce the viscosity of ink in the Printhead nozzles before starting to print.

■ Scheduled Flushing

This is performed to prevent ink in the Printhead nozzles from increasing its viscosity during printing.

2.2.7 Power-On Sequence

The following describes the printer operation after it is powered on.

When the Carriage Unit is in the Home Position with the CR Locked

1. After power-on, the drive of the APG Motor is transmitted to the Carriage Shaft, and the PG position changes from PG Typ. to PG++.
2. The drive of the CR Motor is transmitted to the Carriage Unit, and the Carriage Unit performs HP detection operation in the following path.
 - Home position ⇒ Right frame ⇒ CR Lock confirmation position ⇒ Right frame ⇒ Home position
3. The drive of the Pump Motor is transmitted to the Cap Unit, the Cap opens (lowers), and the CR Lock is released.
4. After the Carriage Unit has moved to the left by the specified number of steps, the Wiper, driven by the Pump Motor, performs the following.
 - Wiper setting ⇒ Wiper resetting
5. The Carriage Unit returns to the home position, and the PG position returns from PG++ to PG Typ.
6. The drive of the PF Motor is transmitted to the PF Roller and Paper Eject Rollers (front and rear) to rotate them for predetermined steps.
7. After moving between the left and right frames twice, the Carriage Unit moves to the right end of the Front Paper Guide.
8. The PF Roller and Paper Eject Rollers (front and rear) rotates.
9. The Carriage Unit returns to the home position and is secured by the CR Lock.

When the Carriage Unit is Out of the Home Position

1. When the PG position is other than PG++ after power-on, the drive of the APG Motor is transmitted to the Carriage Shaft, and the PG position changes to PG++.
2. The drive of the CR Motor is transmitted to the Carriage Unit, and the Carriage Unit returns to the home position at slow speed.
3. The drive of the PF Motor is transmitted to the PF Roller and Paper Eject Rollers (front and rear), which then rotate for about 2 seconds.
4. After the Carriage Unit has moved to the left by the specified number of steps, the Wiper is set by the drive of the Pump.
5. After the Carriage Unit has returned to the home position, it moves to the left again by the specified number of steps. Then driven by the Pump Motor, ink is sucked in for about 4 seconds, then the Wiper is set, and the CR Lock is locked.
6. The Carriage Unit performs HP detection operation in the following path.
 - Home position ⇒ Right frame ⇒ CR Lock confirmation position ⇒ Right frame ⇒ Home position
7. The drive of the Pump Motor is transmitted to the Cap Unit, the Cap opens (lowers), and the CR Lock is released.
8. The Carriage Unit returns to the home position, and the PG position returns from PG++ to PG Typ.
9. The PF Motor drive is transmitted to the PF Roller and the Paper EJ Rollers (front and rear) to rotate them for predetermined steps.
10. Steps 7 to 9 of *“When the Carriage Unit is in the Home Position with the CR Locked (p34)”* is carried out, and the Carriage Unit is locked.

2.3 Electrical Circuit Operating Principles

The electrical circuit of EPSON Stylus Photo 1390/1400/1410 consists of the following circuits.

- Control circuit board: C655 MAIN
- Power supply circuit board: C589 PSB
- Control panel board: C589 PNL
- Head circuit board: C653 HEAD

The following shows how the four circuit boards are connected.

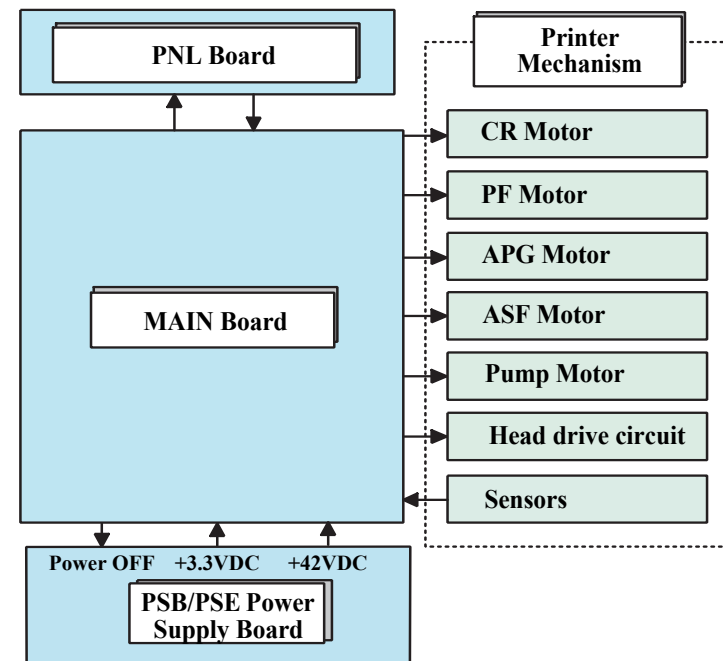

Figure 2-12. Electrical Circuit Block Diagram

2.3.1 Power Supply Circuit Operating Principle

The power supply circuit board of this product is the C589 PSB.

- Basic circuit structure
 - Flyback switching system
 - +42VDC and +3.3VDC are supplied to the Printer Mechanism and Control Board

The following indicates the applications of the voltages generated in this power supply circuit.

Table 2-9. Supplied Power

Voltage	Applications
+42VDC Rated output current: 0.45A	<ul style="list-style-type: none"> • CR Motor • PF Motor • PG Motor • ASF Motor • Pump Motor • Head drive voltage
+3.3VDC Rated output current: 0.5A	<ul style="list-style-type: none"> • Logic sensor circuit • Sensor circuit • Nozzle selection circuit (on the Printhead) • Interface control circuit

The following is a block diagram of the power supply circuit.

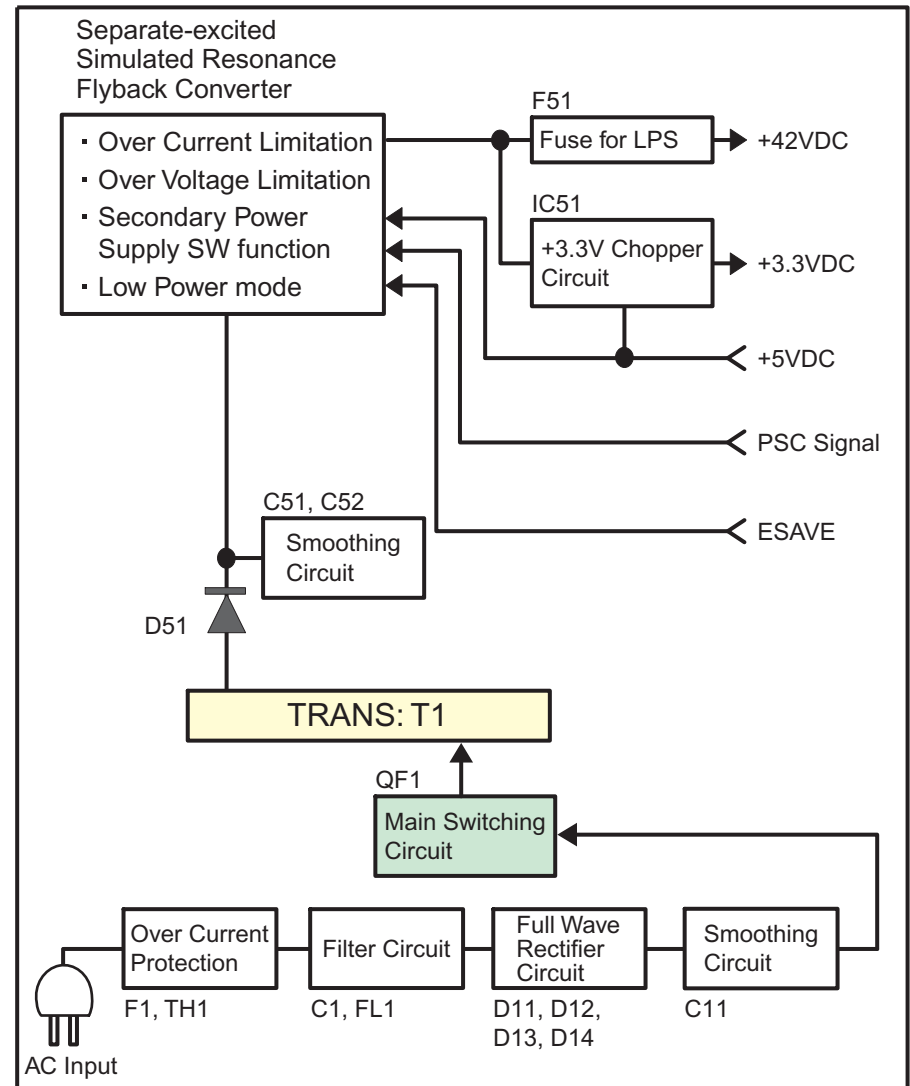

Figure 2-13. Power Supply Circuit Block Diagram

2.3.2 C655 MAIN Circuit Operating Principle

The C655 MAIN Board consists of the following circuits and sensors.

- Logic Circuits (CPU-ASIC 2 in 1, PROM, SDRAM)
- Circuits for controlling and driving Motors
(CR Motor, PF Motor, APG Motor, ASF Motor, Pump Motor)
- Circuits for controlling and driving the Head
- Interface Circuits (USB 2.0)
- Sensor Circuits
- RTC Circuit
- DAC Converter Circuit
- Regulator Circuit
- Complex Circuit (IC8)
The Complex Circuit (IC8) that consists of EEPROM, RTC, and Reset circuit is installed in the printer. Employing a large-capacity condenser for the Timer allows to backup the time recorded at power-off for about a week after the power-off.

The following is the block diagram of the C655 MAIN control board.

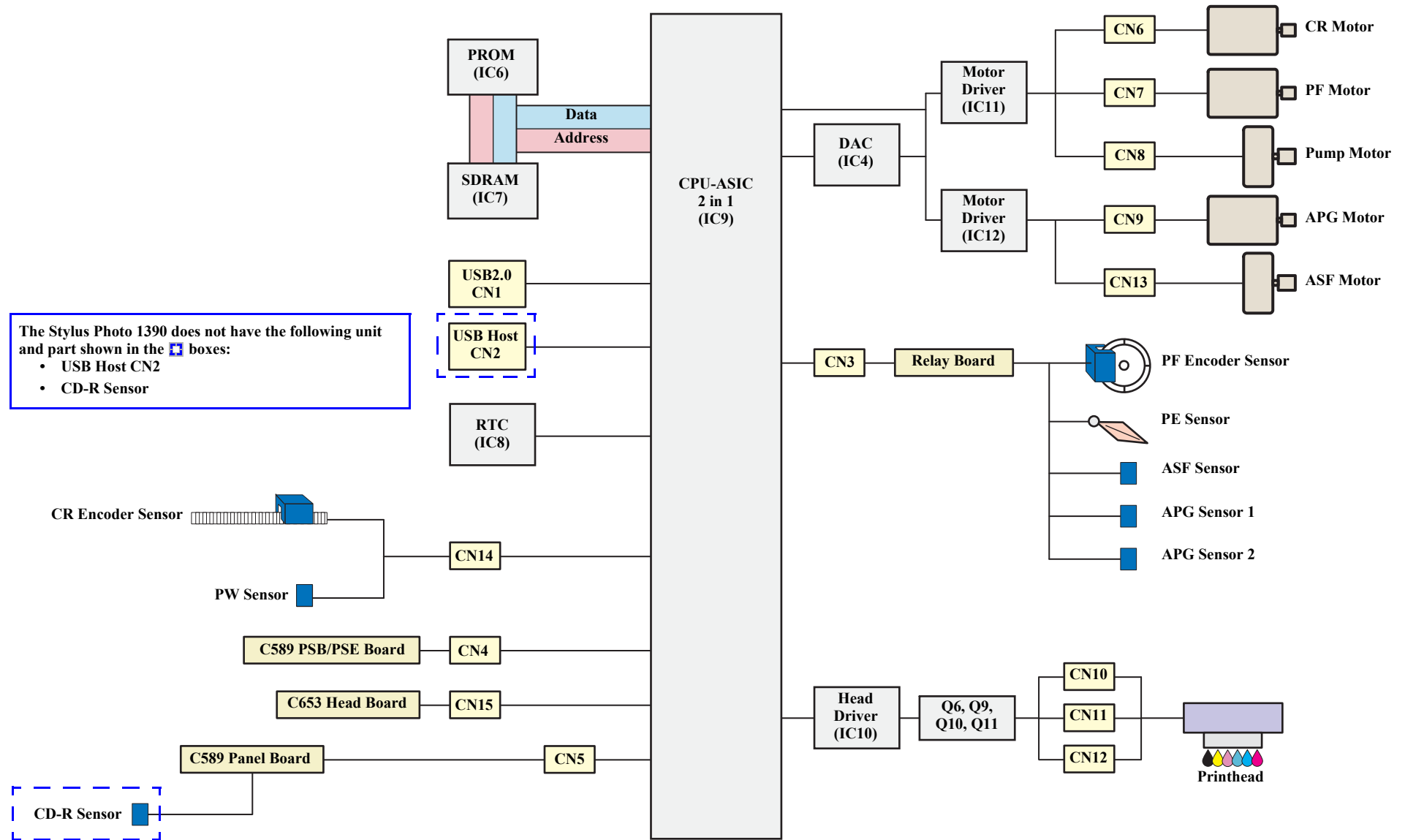

Figure 2-14. C655 MAIN Control Board Block Diagram

CHAPTER

3

TROUBLESHOOTING

3.1 Overview

This chapter describes unit-level troubleshooting.

3.1.1 Troubleshooting according to Panel Messages

After checking the printer LED and STM3 error indications, you can grasp the fault location using the check list in this section. When you find the fault location, refer to Chapter 4 “Disassembly and Reassembly” and change the corresponding part and/or unit. The following table indicates the check point reference tables corresponding to the error states (LED and STM3).



As the photos and illustrations used in this chapter are of Stylus Photo 1400/1410, there may be some differences in the appearance but the errors and remedies itself are not affected.

Table 3-1. Reference Tables of Error States

Error State	Reference Table
Communication Error	<i>Refer to Table 3-2 "Troubleshooting of Communication Error" on page 41</i>
Model Difference	<i>Refer to Table 3-2 "Troubleshooting of Communication Error" on page 41</i>
Cover Open (Tray) Error	<i>Refer to Table 3-3 "Troubleshooting of Cover Error" on page 44</i>
Paper Out Error	<i>Refer to Table 3-4 "Troubleshooting of Paper Out Error" on page 44</i>
Paper Jam Error	<i>Refer to Table 3-5 "Troubleshooting of Paper Jam Error" on page 48</i>
Paper Mismatch Error	<i>Refer to Table 3-6 "Troubleshooting of Paper Mismatch Error" on page 49</i>
Ink Low	<i>Refer to Table 3-7 "Troubleshooting of Ink Low" on page 49</i>
Ink End Error	<i>Refer to Table 3-8 "Troubleshooting of Ink End Error" on page 49</i>
No Ink Cartridge/CSIC Error	<i>Refer to Table 3-9 "Troubleshooting of No Ink Cartridge/CSIC Error" on page 50</i>
Maintenance Request Error	<i>Refer to Table 3-10 "Troubleshooting of Maintenance Request" on page 52</i>
Fatal Error	<i>Refer to Table 3-11 "Troubleshooting of Fatal Error" on page 53</i>

Table 3-2. Troubleshooting of Communication Error

Occurrence Timing	Phenomenon Detail	Faulty Part/ Part Name	Check Point	Remedy
At power-on	The printer does not operate at all.	Panel FFC	1. Check that the Panel FFC is connected to the Panel Board Connector and Main Board Connector CN5. 	1. Connect the Panel FFC to the Panel Board and Main Board connector CN5.
			2. Check the Panel FFC for damages.	2. Replace the Panel FFC with a new one.
		Panel Board	1. Check the Panel Board for damages.	1. Replace the Panel Board with a new one.

Table 3-2. Troubleshooting of Communication Error

Occurrence Timing	Phenomenon Detail	Faulty Part/ Part Name	Check Point	Remedy
<p>At power-on</p>	<p>The printer does not operate at all.</p>	<p>Power Supply Board</p>	<p>1. Check that the Connector Cable of the Power Supply Board is connected to the Main Board Connector CN4.</p> 	<p>1. Connect the Connector Cable of the Power Supply Board to the Main Board Connector CN4.</p>
			<p>2. Make sure that the Power Supply Board connector cable is inserted into the Main Board Connector CN4 with the blue line on the cable facing the Pin 1 side of the connector as shown in the picture above.</p>	<p>2. Reconnect the Power Supply Board Connector cable so that the blue line is inserted into the Pin 1.</p>
			<p>3. Check that the Fuse F1 on the Power Supply Board has not blown.</p> 	<p>3. Replace the Power Supply Board with a new one.</p>
			<p>4. Check the components on the Power Supply Board for damage.</p>	<p>4. Replace the Power Supply Board with a new one.</p>

Table 3-2. Troubleshooting of Communication Error

Occurrence Timing	Phenomenon Detail	Faulty Part/ Part Name	Check Point	Remedy
At power-on	After the power-on sequence has started, the LED turns off and the printer does not operate.	Main Board	1. Check that the Relay connector of the ASF Motor and the Relay connector of the Pump Motor are not connected to the wrong connectors causing a short circuit. 	1. Connect the Relay Connector of the ASF Motor and the Relay Connector of the Pump Motor correctly, and replace the Main Board with a new one.
At operation	Operation at power-on is normal, but an error appears when the print job is sent to the printer.	Interface cable	1. Check that the Interface cable is connected between the PC and the printer.	1. Connect the Interface cable to the PC and the printer.
			2. Check the Interface cable for breaking.	2. Replace the Interface cable with a new one.
		EPSON USB driver	1. When using USB, check that the EPSON USB driver has been installed on the PC.	1. Install the EPSON USB driver.
		USB	1. Check that the PC and printer are connected via the USB hub.	1. Enter the USB serial No. indicated on the product nameplate. Refer to Chapter 5 " <i>ADJUSTMENT</i> ".
		Printer Driver	1. Check that the printer driver for Stylus Photo 1390/1400/1410 has already been installed.	1. Install the printer driver for Stylus Photo 1390/1400/1410.
			2. Check that the connected printer is EPSON Stylus Photo 1390/1400/1410.	2. Connect the Stylus Photo 1390/1400/1410 printer.
Main Board	1. Check that a wrong model name has not been input to the EEPROM address on the Main Board.	1. Using the Adjustment Program, enter the correct model name. Refer to Chapter 5 " <i>ADJUSTMENT</i> ".		

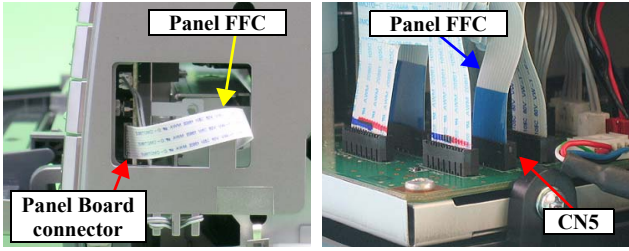
Table 3-3. Troubleshooting of Cover Error

Occurrence Timing	Phenomenon Detail	Faulty Part/ Part Name	Check Point	Remedy
During printing*	A Cover Open (Tray) Error is indicated during printing.	Printer Cove	1. Check that the CD-R Unit is not open.	1. Close the CD-R Unit.

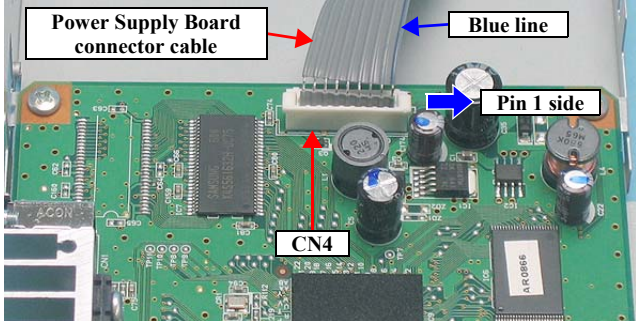
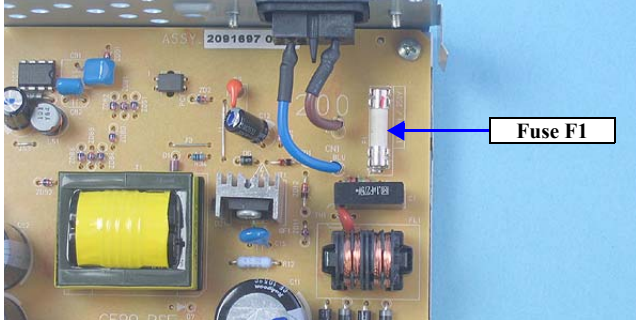
Note *: Stylus Photo 1390 does not have the CD/DVD-related units.

Table 3-4. Troubleshooting of Paper Out Error

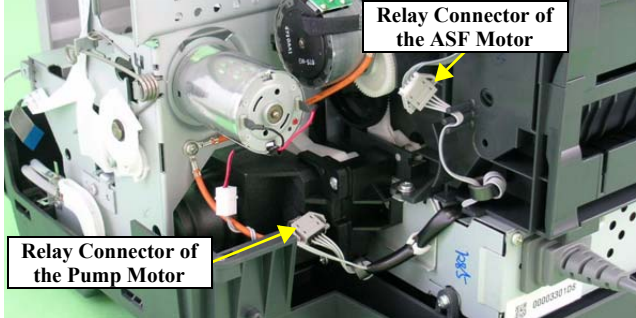
Occurrence Timing	Phenomenon Detail	Faulty Part/ Part Name	Check Point	Remedy
At operation	When the Paper button is pressed, the LD Roller attempt to feed paper but the paper is not fed.	ASF Assy.	1. Check the LD Roller or Retard Roller of the ASF Assy for paper dust and foreign matter.	<p>1. Using a cleaning sheet (part code:1262115), clean the LD Roller and Retard Roller. The procedure is as follows.</p> <p>(1) Place the cleaning sheet upside down and put it into the ASF Assy.</p> <p>(2) Press the Paper button to start paper feed.</p> <p>(3) Repeat the above steps several times.</p> <p>* To remove persistent contamination, staple an alcohol-dampened cloth to a postcard and clean the rollers in the following method.</p> <div style="text-align: center;"> </div> <p>(1) Place the alcohol-dampened cloth facing to the LD Roller surface of the ASF Assy.</p> <p>(2) Hold the mount top end securely and press the Paper button.</p> <p>(3) Repeat the paper feed sequence several times to clean the LD Roller surface of the ASF Assy.</p>

Table 3-4. Troubleshooting of Paper Out Error

Occurrence Timing	Phenomenon Detail	Faulty Part/ Part Name	Check Point	Remedy
At operation	Though paper is fed from the ASF Assy, it stops near the PE Sensor Lever.	PE Sensor	1. Check that the Connector cable of the PE Sensor is securely connected to the PE Sensor and Relay Board Connector CN2. <div style="display: flex; justify-content: space-around; margin-top: 10px;">   </div>	1. Connect the Connector cable of the PE Sensor to the PE Sensor and Relay Board Connector CN2.
			2. Check that the Sensor Holder is mounted to the Mechanical frame correctly. <div style="margin-top: 10px;">  </div>	2. Install the Sensor Holder correctly.
			3. Move the Detection Lever manually as when the paper passes, and check that the Detection Lever returns to the original position automatically by the Torsion Spring when released. Refer to the above photo.	3. Replace the PE Sensor Holder Unit with a new one.
			4. Using a tester, check that the PE Sensor is normal. <ul style="list-style-type: none"> · Paper absent: 2.4V or more · Paper present: 0.4V or less 	4. Replace the PE Sensor Holder Unit with a new one.

Table 3-4. Troubleshooting of Paper Out Error

Occurrence Timing	Phenomenon Detail	Faulty Part/ Part Name	Check Point	Remedy
<p>The Paper button was pressed at the setting of the CD/DVD Tray.*</p>	<p>The CD/DVD Tray HP detection sequence stops and the Tray is ejected.</p>	<p>CD/DVD Tray</p>	<p>1. Check the HP detection position or white markings of the CD/DVD Tray for paper dust and foreign matter.</p>  <p>The diagram shows the interior of a CD/DVD tray. A blue arrow points to a small white rectangular area on the right side labeled 'HP detection position'. A yellow circle highlights a small white square on the left side labeled 'White Markings'. Another yellow circle highlights a larger white rectangular area at the bottom center.</p>	<p>1. Remove paper dust and/or foreign matter from the detection position.</p>
			<p>2. Check the Driven Roller surface for contamination such as paper dust and CD-R coating material.</p>	<p>2. Feed A4-size sheets of plain paper from the ASF Assy several times to remove the contamination.</p>
			<p>3. Check that the HP detection position or white markings of the CD/DVD Tray are not chipped.</p>	<p>3. Replace the CD/DVD Tray with a new one.</p>
	<p>The CD/DVD Tray is fed toward the ASF Assy, but is ejected immediately.</p>	<p>PW sensor</p>	<p>1. Check the PW Sensor for contamination such as paper dust, ink, etc.</p>  <p>The image shows the bottom of the carriage unit. A red arrow points to a small black sensor component labeled 'PW sensor'. A white box at the bottom of the image is labeled 'Carriage Unit Bottom'.</p> <p>2. Compare the EEPROM values in two places and check that they are not approximated to each other.</p>	<p>1. Clean the PW Sensor surface.</p> <p>2. Replace the PW Sensor with a new one.</p>

Table 3-4. Troubleshooting of Paper Out Error

Occurrence Timing	Phenomenon Detail	Faulty Part/ Part Name	Check Point	Remedy
<p>The Paper button was pressed at the setting of the CD/DVD Tray.*</p>	<p>The CD/DVD Tray moves toward the ASF and the back end of it reaches to the Driven Roller on the Upper Paper Guide. Then the CD/DVD Tray tries to go farther, but it is ejected.</p>	<p>PW sensor</p>	<p>1. Check that the PW Sensor FFC is placed in the specified routing positions and it does not make contact with any parts.</p>	<p>1. Place the PW Sensor FFC in the specified routing positions.</p>
				
			<p>2. Check that the PW Sensor FFC is connected to the CR Encoder Board and PW Sensor Connector. Refer to the above photo.</p>	<p>2. Connect the FFC to the CR Encoder Board and PW Sensor Connector.</p>
<p>3. Check the PW Sensor or PW Sensor FFC for damages.</p>	<p>3. Replace the PW Sensor with a new one.</p>			

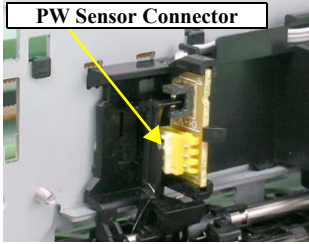
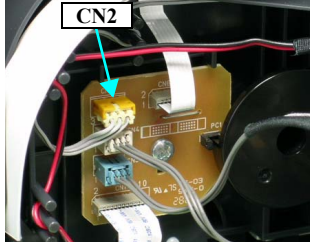
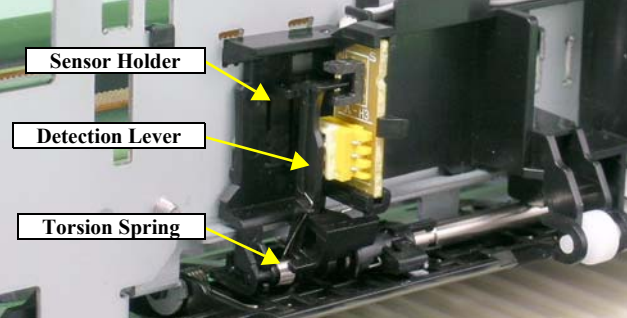
Note *: Stylus Photo 1390 does not have the CD/DVD-related units.

Table 3-5. Troubleshooting of Paper Jam Error

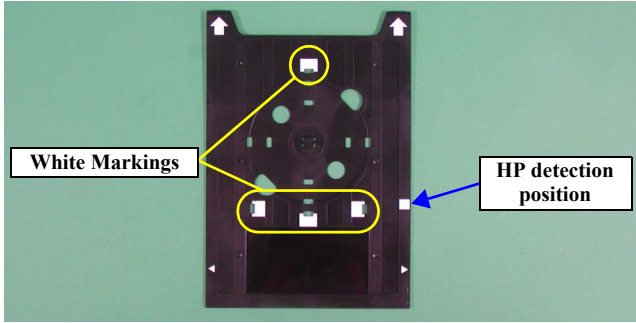
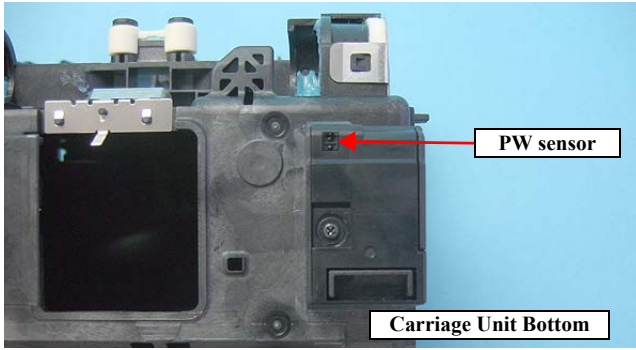
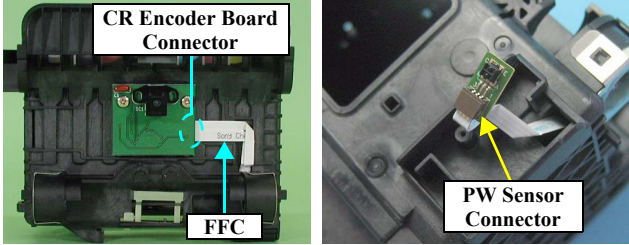
Occurrence Timing	Phenomenon Detail	Faulty Part/ Part Name	Check Point	Remedy
At operation	At the time of paper ejection, the PF Roller advances the paper but cannot eject it completely.	-	1. Check that the size of the fed paper is not larger than that of the paper specified by the driver.	1. Tell the user that the paper size specified by the driver is not available for the printer.
	Paper is not ejected completely and causes a jam near the Paper Eject Frame.	ASF Assy.	1. Check that the paper is fed along the Right Edge Guide.	1. Feed the paper along the Right Edge Guide.
		Paper EJ Frame Assy.	1. Check that the Star Wheel Units have not come off the Paper EJ Frame Assy.  2. Check the Paper EJ Frame Assy for deformation or damages.	1. Securely install the Star Wheel Units to the Paper EJ Frame Assy.
	Spur Gear 68 Spur Gear 16; B Paper EJ Roller Assy (front/rear)	1. Check the Spur Gear 68 or Spur Gear 16; B for damages. 	1. Replace the Front (or Rear) Paper EJ Roller Assy with a new one.	

Table 3-6. Troubleshooting of Paper Mismatch Error

Occurrence Timing	Phenomenon Detail	Faulty Part/ Part Name	Check Point	Remedy
At operation*	When feeding a CD-R (Board Paper), an error is displayed on the LED and STM3.	Paper EJ Frame Assy (CD/DVD Tray Base)	1. Check if the CD/DVD Tray Base is closed or not.	1. Open the CD/DVD Tray Base.
		CD-R Sensor	1. Check that the Connector cable of the CD-R Sensor is securely connected to the connectors of the CD-R Sensor and Panel Board. 	1. Connect the Connector cable of the CD-R Sensor to the CD-R Sensor and Panel Board Connectors.
			2. Check the CD-R Sensor or Connector cable for damages.	2. Replace the CD-R Sensor with a new one.

Note *: Stylus Photo 1390 does not have the CD/DVD-related units.

Table 3-7. Troubleshooting of Ink Low

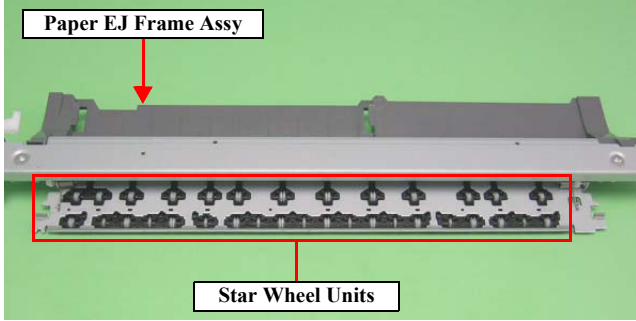
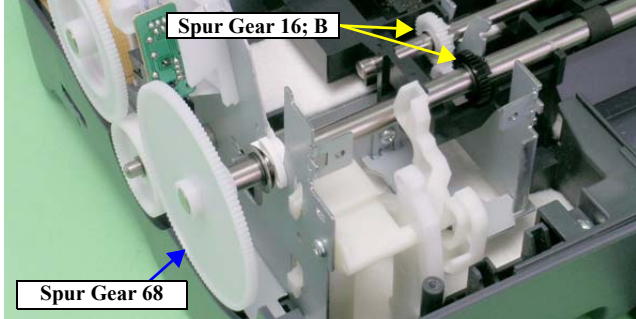
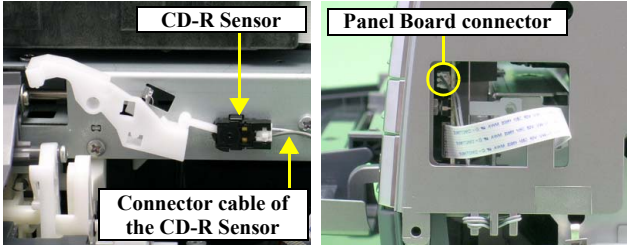
Occurrence Timing	Phenomenon Detail	Faulty Part/ Part Name	Check Point	Remedy
At operation or during printing	A message is displayed on the LED and STM3 during printing.	Ink Cartridge	1. Look at the remaining ink indication of the STM3 to check the amount of the ink remaining in the Ink Cartridge.	1. Prepare a new Ink Cartridge.

Table 3-8. Troubleshooting of Ink End Error

Occurrence Timing	Phenomenon Detail	Faulty Part/ Part Name	Check Point	Remedy
During printing	After the Carriage has detected the HP, an error is displayed on the LED and STM3.	Ink Cartridge	1. Look at the remaining ink indication of the STM3 to check whether the ink remains in the Ink Cartridge.	1. Replace the Ink Cartridge with a new one.

Table 3-9. Troubleshooting of No Ink Cartridge/CSIC Error

Occurrence Timing	Phenomenon Detail	Faulty Part/ Part Name	Check Point	Remedy
At power-on	After the Carriage has detected the HP, an error is displayed on the LED and STM3.	Ink Cartridge	1. Check that the Ink Cartridge is installed correctly.	1. Install the Ink Cartridge correctly.
			2. Check that the tab of the Ink Cartridge is not broken.	2. Replace the Ink Cartridge with a new one.
				
3. Check that the Memory Chip is not disconnected or not damaged.	3. Replace the Ink Cartridge with a new one.			
				

Table 3-9. Troubleshooting of No Ink Cartridge/CSIC Error

Occurrence Timing	Phenomenon Detail	Faulty Part/ Part Name	Check Point	Remedy
At power-on	After the Carriage has detected the HP, an error is displayed on the LED and STM3.	CSIC FFC	1. Check that the CSIC FFC is connected to the CSIC Board Connector and Main Board Connector CN15. 	1. Connect the CSIC FFC to the CSIC Board Connector and Main Board Connector CN15.
		CSIC Board	1. Check the CSIC Board for damage. 	2. Replace the CSIC FFC with a new one.
		Carriage Unit	1. Check that the electrodes on the CSIC Board, which make contact with the Ink Cartridge are not bent. 	1. Replace the CSIC Board with a new one.

Table 3-10. Troubleshooting of Maintenance Request

Occurrence Timing	Phenomenon Detail	Faulty Part/ Part Name	Check Point	Remedy
At power-on	At power-on, the printer does not operate at all.	Waste Ink Pads	1. Using the Adjustment Program, check if the Protection Counter A+B value has exceeded 17455.	1. Replace the Waste Ink Pads and reset the Protection Counter A and B value in the Adjustment Program.

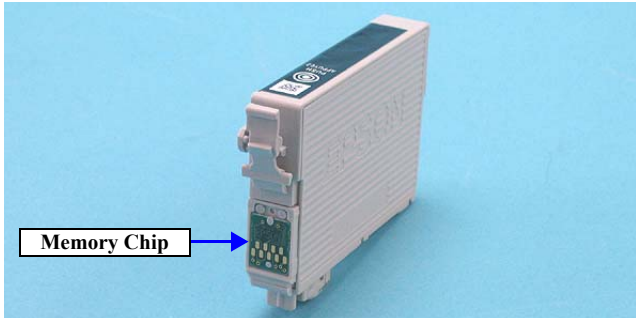
Table 3-11. Troubleshooting of Fatal Error

Occurrence Timing	Phenomenon Detail	Faulty Part/ Part Name	Check Point	Remedy
At power-on	At power-on, the CR Motor does not operate at all.	CR Motor	1. Check that the CR Motor connector cable is connected to the Relay Connector.	1. Connect the CR Motor connector to the Relay Connector.
				2. Replace the CR Motor with a new one.
			3. Check if the CR Motor operates normally.	3. Replace the CR Motor with a new one.
		Relay Connector Cable (for the CR Motor)	1. Check that the Relay Connector Cable is connected to the Main Board Connector CN6.	1. Connect the Relay Connector Cable to the Main Board Connector CN6.
				2. Replace the Relay Connector Cable with a new one.
			2. Check the Relay Connector Cable for damages.	

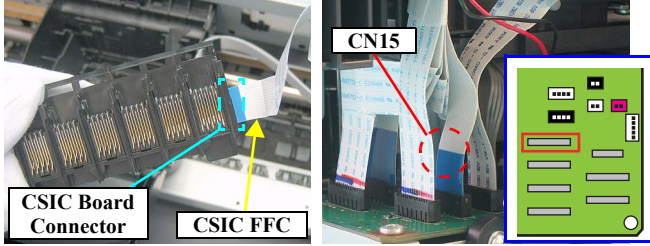
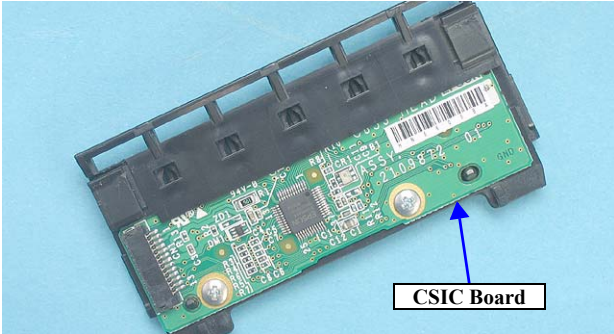
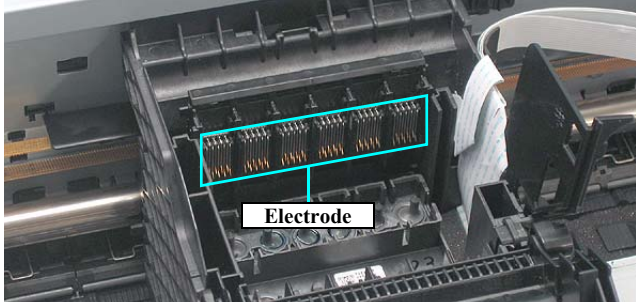
Table 3-11. Troubleshooting of Fatal Error

Occurrence Timing	Phenomenon Detail	Faulty Part/ Part Name	Check Point	Remedy
At power-on	The power-on sequence is executed but Fatal error is displayed.	CR drive mechanism	1. Check that the Carriage Shaft is lubricated with grease. 	1. Wipe the surface of the Carriage Shaft with a dry, soft cloth, and lubricate the Carriage Shaft with grease G-71. Refer to Chapter 6 "MAINTENANCE".
	At power-on, the PF Motor does not operate at all.	PF Motor	1. Check that the Connector Cable of the PF Motor is connected to the Main Board Connector CN7. 	1. Connect the PF Motor connector cable to the Main Board Connector CN7.
			2. Check the PF Motor connector cable for damages.	2. Replace the PF Motor with a new one.
			3. Check if the PF Motor operates normally.	3. Replace the PF Motor with a new one.

Table 3-11. Troubleshooting of Fatal Error

Occurrence Timing	Phenomenon Detail	Faulty Part/ Part Name	Check Point	Remedy
At power-on	At power-on, the APG Motor does not operate at all.	APG Motor	1. Check that the Connector Cable of the APG Motor is connected to the Main Board Connector CN9.	1. Connect the APG Motor connector cable to the Main Board Connector CN9.
				
			2. Check the APG Motor connector cable for damage.	
			3. Check if the APG Motor operates normally.	3. Replace the APG Motor with a new one.
At power-on	At power-on, the Pump Motor does not operate at all.	Pump Motor	1. Check that the Pump Motor connector cable is connected to the Relay Connector.	1. Connect the Pump Motor connector cable to the Relay Connector.
				
			2. Using a tester, check the resistance value of the Pump Motor. Value of resistance: $10.3\Omega \pm 10\%$	
			3. Check the Pump Motor connector cable for damages.	3. Replace the Ink System Unit with a new one.

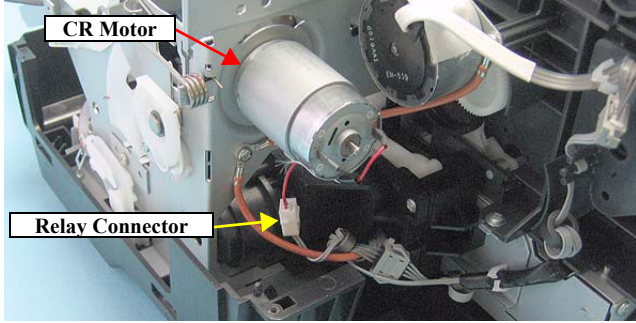
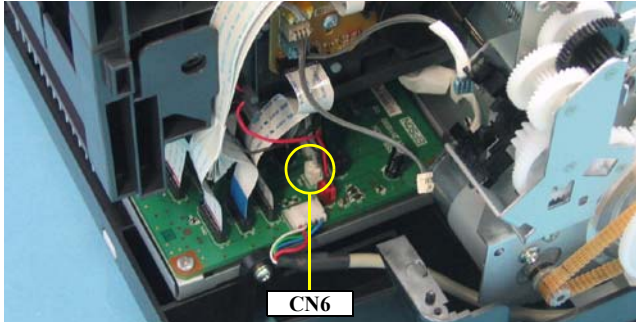
Table 3-11. Troubleshooting of Fatal Error

Occurrence Timing	Phenomenon Detail	Faulty Part/ Part Name	Check Point	Remedy
At power-on	At power-on, the Pump Motor does not operate at all.	Relay Connector Cable (for Pump Motor)	1. Check that the Relay Connector Cable is connected to the Main Board Connector CN8. 	1. Connect the Relay Connector Cable to the Main Board Connector CN8.
			2. Check the Relay Connector Cable for damages.	2. Replace the Relay Connector Cable with a new one.
	While the power-on sequence is being executed, Fatal error is displayed.	APG Sensor	1. Check that the APG Sensor Connector cables are connected to the APG Sensors and Relay Board Connector CN4 and CN5. 	1. Connect the APG Sensor Connector cables to the APG Sensors and Relay Board Connector CN4 and CN5.
			2. Check the APG Sensors for damages.	2. Replace the APG Sensors with new ones.

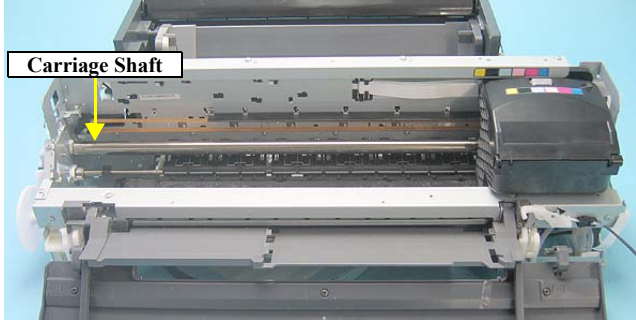
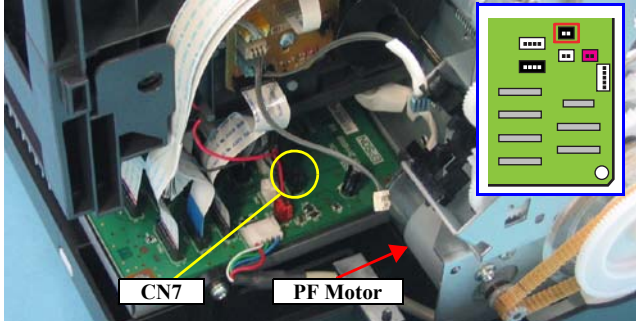
Table 3-11. Troubleshooting of Fatal Error

Occurrence Timing	Phenomenon Detail	Faulty Part/ Part Name	Check Point	Remedy
At power-on	While the power-on sequence is being executed, Fatal error is displayed.	ASF Motor	1. Check that the Connector cable of the ASF Motor is connected to the Relay Connector. 	1. Connect the Connector cable of the ASF Motor to the Relay Connector.
			2. Using a tester, check the resistance value of the ASF Motor. Value of resistance: $7.0\Omega \pm 10\%$	2. If the resistance value is abnormal, replace the ASF Motor with a new one.
			3. Check the ASF Motor connector cable for damages.	3. Replace the ASF Motor with a new one.
		Relay Connector Cable (for the ASF Motor)	1. Check that the Relay Connector Cable is connected to the Main Board Connector CN13. 	1. Connect the Relay Connector Cable to the Main Board Connector CN13.
			2. Check the Relay Connector Cable for damages.	2. Replace the Relay Connector Cable with a new one.

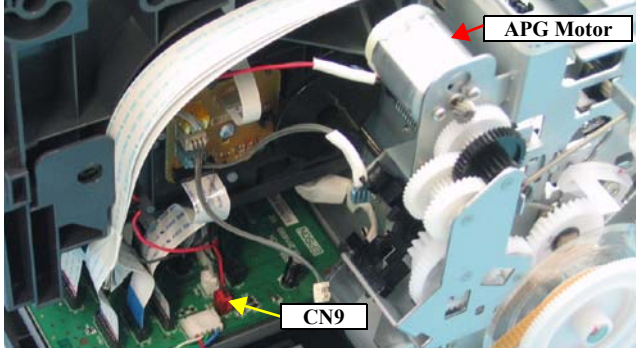
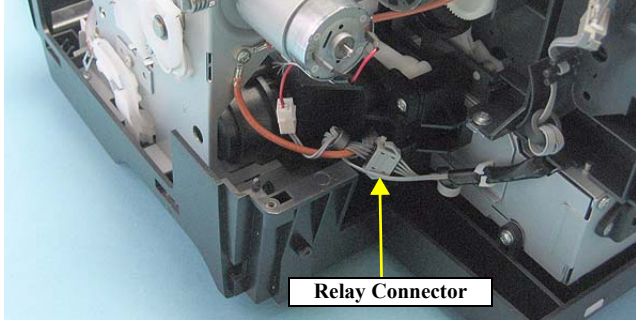
Table 3-11. Troubleshooting of Fatal Error

Occurrence Timing	Phenomenon Detail	Faulty Part/ Part Name	Check Point	Remedy
At power-on	While the power-on sequence is being executed, Fatal error is displayed.	Relay FFC	1. Check that the Relay FFC is connected to the Relay Board Connector CN1 and Main Board Connector CN5. 	1. Connect the Relay FFC to the Relay Board Connector CN1 and Main Board Connector CN5.
			2. Check the Relay FFC for damages.	2. Replace the Relay FFC Cable with a new one.
	At power-on, the Carriage Unit moves away from the home position and bumps against the right of the Frame, then hits the left of the Frame.	CR Scale	1. Check that the CR Scale is inserted in the slit of the CR Encoder Sensor. 	1. Insert the CR Scale into the slit of the CR Encoder Sensor.
		CR Encoder Sensor Board	2. Check the CR Scale for damages and dirt.	2. Wipe off the dirt completely or replace the CR Scale with a new one.
			1. Check the CR Encoder Sensor for paper dust, etc. 2. Check the CR Encoder Sensor Board for damages.	1. Remove the paper dust, etc. from the CR Encoder Sensor. 2. Replace the CR Encoder Sensor Board with a new one.

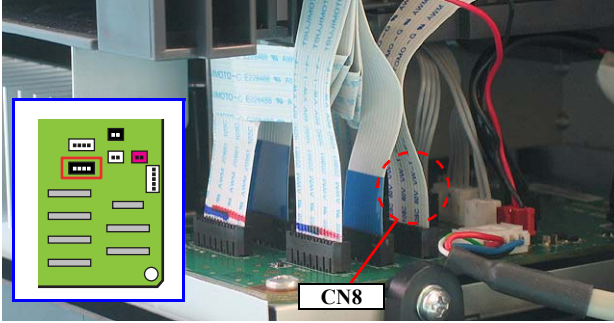
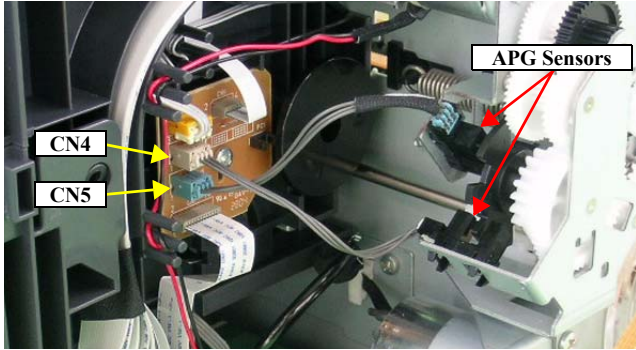
Table 3-11. Troubleshooting of Fatal Error

Occurrence Timing	Phenomenon Detail	Faulty Part/ Part Name	Check Point	Remedy
At power-on	At power-on, the Carriage Unit moves away from the home position and bumps against the right of the Frame, then hits the left of the Frame.	Sensor FFC	1. Check that the Sensor FFC is connected to the CR Encoder Sensor Board Connector and Main Board Connector CN14. <div style="display: flex; justify-content: space-around; margin-top: 10px;">   </div>	1. Connect the Sensor FFC to the CR Encoder Sensor Board Connector and Main Board Connector CN14.
			2. Check the Sensor FFC for damages.	2. Replace the Sensor FFC with a new one.
	At power-on, the PF Roller rotates fast about a half turn.	PF Encoder Sensor Holder	1. Check that the PF Encoder Sensor Holder is mounted correctly.	1. Install the PF Encoder Sensor Holder correctly.
			2. Check that the FFC of the PF Encoder Sensor is securely connected to the PF Encoder Sensor Board Connector and Relay Board Connector CN6. <div style="display: flex; justify-content: space-around; margin-top: 10px;">   </div>	2. Connect the PF Encoder Sensor FFC to the PF Encoder Sensor Board and Relay Board Connector CN6.
			3. Check the PF Encoder Sensor for paper dust, etc.	3. Remove the paper dust, etc. from the PF Encoder Sensor.
			4. Check if the PF Encoder or the FFC is damaged.	4. Replace the PF Encoder with a new one.

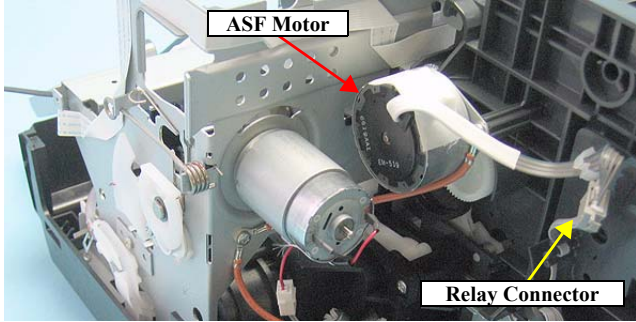
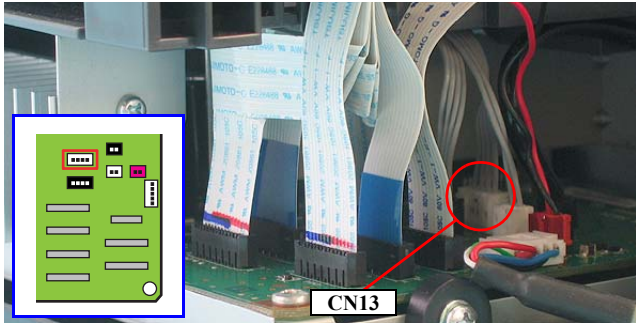
Table 3-11. Troubleshooting of Fatal Error

Occurrence Timing	Phenomenon Detail	Faulty Part/ Part Name	Check Point	Remedy
At power-on	At power-on, the PF Roller rotates fast about a half turn.	PF Scale	1. Check that the PF Scale is inserted in the slit of the PF Encoder Sensor.	1. Install the PF Scale in the slit of the PF Encoder Sensor correctly. 2. Replace the PF Scale with a new one.
				
During printing*	After receiving a print data, or while performing the CD/DVD Tray home position detection sequence, an error is displayed on the LED and STM3.	CSIC FFC Head FFC Sensor FFC	1. Check that the CSIC FFC, Head FFC, and the Sensor FFC are securely connected to the Main Board Connectors CN10, CN11, CN12, CN14 and CN15.	1. Connect the CSIC FFC, Head FFC, and the Sensor FFC to the Main Board Connectors CN10, CN11, CN12, CN14 and CN15.
				

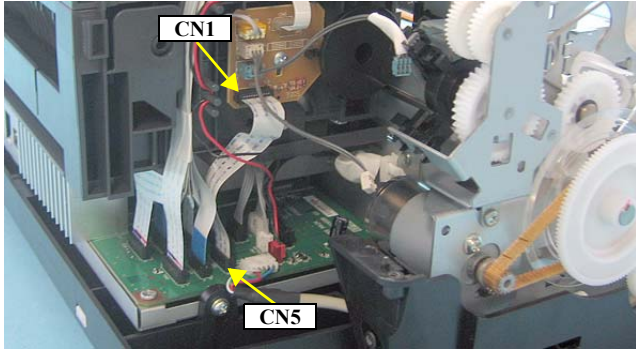
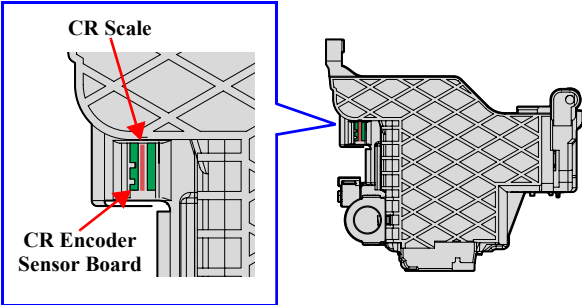
Note *: Stylus Photo 1390 does not have the CD/DVD-related units.

Table 3-11. Troubleshooting of Fatal Error

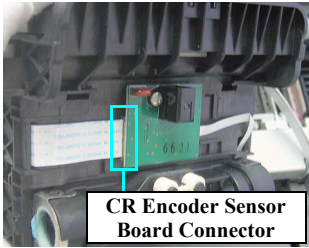
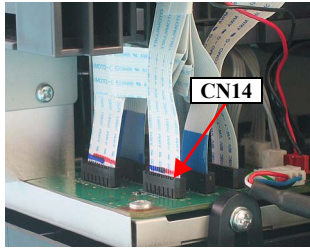
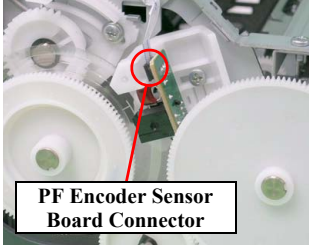
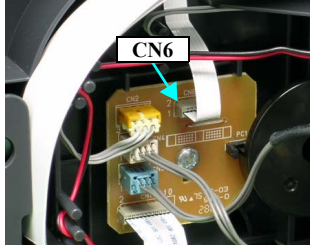
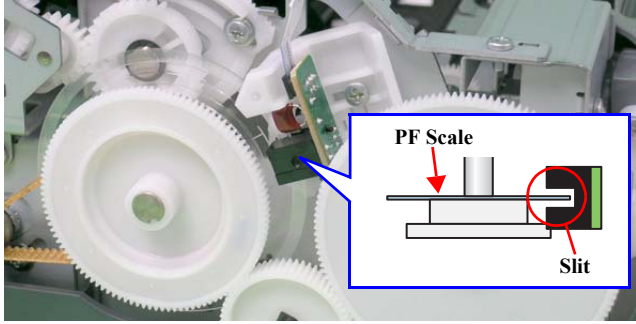
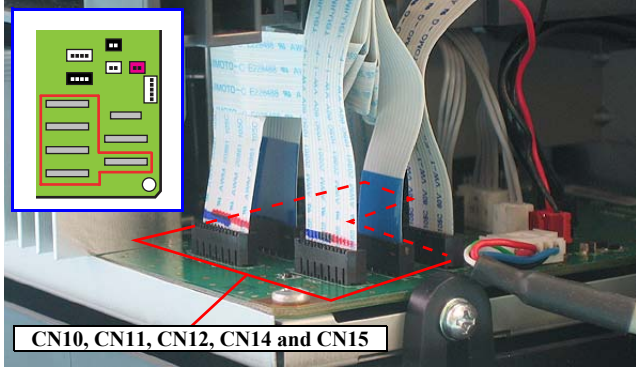
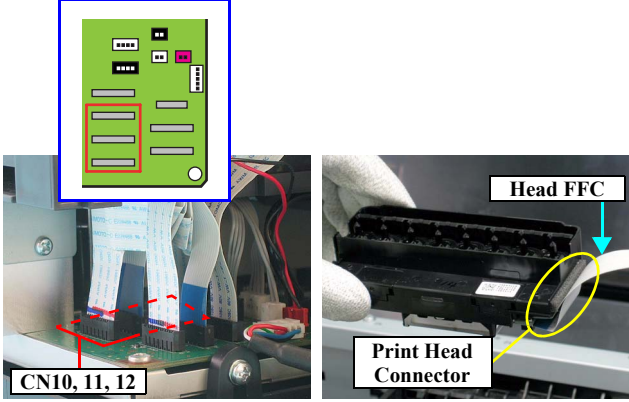
Occurrence Timing	Phenomenon Detail	Faulty Part/ Part Name	Check Point	Remedy
During printing	After starting to print, ink is not ejected and paper stops midway.	Head FFC	1. Check that the Head FFC is securely connected to the Print Head Connector and Main Board Connectors CN10, CN11 and CN12. 	1. Connect the Head FFC to the Print Head Connector and Main Board Connectors CN10, CN11 and CN12.
	Ink is not ejected from most nozzles.	Print Head	2. Check the Head FFC for damages. 1. Check for occurrence of Head Hot.	2. Replace the Head FFC with a new one. 1. Replace the Print Head with a new one.

3.1.2 Troubleshooting based on Observed Faults

This section provides troubleshooting procedures based on observed faults such as print quality troubles and abnormal noise.

Table 3-12. Print Quality Troubles

Observed Faults	Details of the Fault	Faulty Part/ Part Name	Check Point	Remedy
<p>Dot missing and mixed colors</p>	<p>Inks are not ejected from the Print Head to the Cap.</p>	<p>Ink System Unit (Cap)</p>	<p>1. Check for foreign matter around the Seal Rubber on the Cap Unit.</p>  <p>The image shows the internal mechanism of the cap unit. A yellow box highlights the 'Seal Rubbers' and a yellow arrow points to the 'Extension Spring, 1.19 IS'.</p>	<p>1. Remove the foreign matter around the Seal Rubber completely.</p>
			<p>2. Check that the Ink Tube is connected to the Pump Tube.</p>  <p>The image shows a close-up of the ink tubes and pump tube. Red arrows point to the 'Ink Tubes' and 'Pump Tube'. A yellow circle highlights the 'Connection point'.</p>	<p>2. Connect the Ink Tube to the Pump Tube securely.</p>
			<p>3. Check that the Extension Spring 1.19 IS is correctly installed to the Cap Unit.</p>	<p>3. Replace the Ink System Unit with a new one.</p>

Table 3-12. Print Quality Troubles

Observed Faults	Details of the Fault	Faulty Part/ Part Name	Check Point	Remedy
<p>Dot missing and mixed colors</p>	<p>Although inks are ejected from the Print Head to the Cap, the trouble still occurs after executing a cleaning cycle or replacing the Ink Cartridges.</p>	<p>Print Head</p>	<p>1. Run a Nozzle Check, and check the printed pattern if it has broken lines or missing segments.</p>	<p>1. After running a Head Cleaning, check the Nozzle Check Pattern again.</p>
		<p>2. Check that the Head FFC is securely connected to the Print Head Connector and Main Board Connectors CN10, CN11, and CN12.</p> 	<p>2. Connect the Head FFC to the Print Head Connector and Main Board Connectors CN10, CN11, and CN12.</p>	
		<p>3. Check the Head FFC for damages.</p>	<p>3. Replace the Head FFC with a new one. If the trouble still occurs after replacing it, replace the Print Head with a new one.</p>	
		<p>Ink System Unit Cleaner Blade</p>	<p>1. Check if the Cleaner Blade is covered with paper dust or is bent.</p> 	<p>1. Replace the Ink System Unit with a new one.</p>
		<p>Main Board</p>	<p>1. Check the Main Board for damages.</p>	<p>1. Replace the Main Board with a new one.</p>

Table 3-12. Print Quality Troubles

Observed Faults	Details of the Fault	Faulty Part/ Part Name	Check Point	Remedy
Horizontal or vertical banding / Getting smeared	Although inks are ejected from the Print Head to the Cap, almost nothing is printed or the print gets smeared with excessive ink after executing a cleaning cycle or replacing the Ink Cartridges.	Head FFC	1. Check that the Head FFC is securely connected to the Print Head Connector and Main Board Connectors CN10, CN11, and CN12. 	1. Connect the Head FFC to the Print Head Connector and Main Board Connectors CN10, CN11, and CN12.
		Print Head	1. Check if the print quality recovers after running a cleaning or replacing the Ink Cartridges.	1. Run the cleaning and replace the Ink Cartridges several times. If the trouble still occurs, replace the Print Head with a new one.
		Main Board	2. Check the Main Board for damages.	2. Replace the Main Board with a new one.

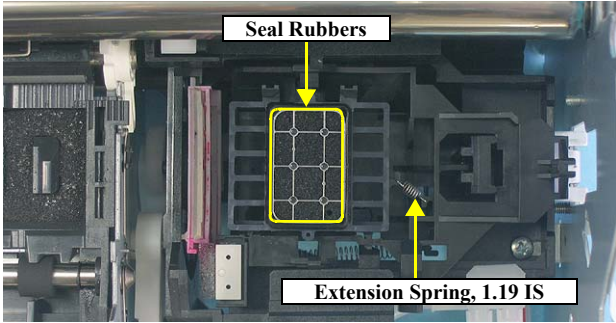
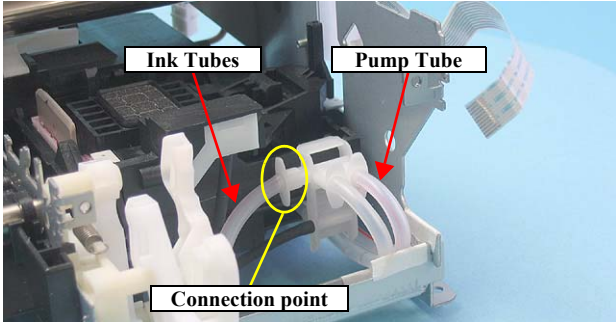
Table 3-12. Print Quality Troubles

Observed Faults	Details of the Fault	Faulty Part/ Part Name	Check Point	Remedy
Vertical or horizontal banding / Color shading	The printout has banding vertical to the CR moving direction and is not evenly colored.  * If the trouble still occurs after doing all measures described in the right-hand columns, replace the CR Motor with a new one.	Adjustment	1. For printing in the Bi-D mode, check that the Bi-D Adjustment has been performed properly.	1. Perform Bi-D Adjustment to eliminate displacements between the upper and lower lines. Refer to Chapter 5 "ADJUSTMENT".
		Print Head	1. Run a Nozzle Check, and check the printed pattern if it has broken lines or missing segments.	1. Perform the Head Cleaning, then check the Nozzle Check Pattern. Refer to Chapter 5 "ADJUSTMENT". If the trouble still occurs, replace the Print Head with a new one.
		Carriage Shaft	1. Check the surfaces of the Carriage Shaft for foreign matter.	1. Remove the foreign matter from the Carriage Shaft.
			2. Check that the Carriage Shaft is fully lubricated with grease.	2. Wipe the grease applied to the Carriage Shaft with a dry, soft cloth, and then apply G-71 grease. Refer to Chapter 6 "MAINTENANCE".
			3. Check that the Carriage Shaft is mounted horizontally.	3. Reassemble the Carriage Shaft correctly.
	4. Check the Carriage Shaft for damages.	4. Replace the Carriage Shaft with a new one.		
	Narrow stripes of the same width appear horizontally to the CR moving direction.  * If the trouble still occurs after doing all measures described in the right-hand columns, replace the PF Motor with a new one.	Printer Driver and the Paper	1. Check if appropriate paper is used in accordance with the Printer Driver settings.	1. Use the appropriate type of paper in accordance with the Printer Driver.
		Print Head	1. Run a Nozzle Check, and check the printed pattern if it has broken lines or missing segments.	1. Perform the Head Cleaning, then check the Nozzle Check Pattern. Refer to Chapter 5 "ADJUSTMENT". If the trouble still occurs, replace the Print Head with a new one.
		PF Roller Shaft	1. Check the surface of the PF Roller Shaft for foreign matter.	1. Clean the PF Roller surface carefully.
			2. Check the PF Roller Shaft for damages.	2. Replace the PF Roller with a new one.

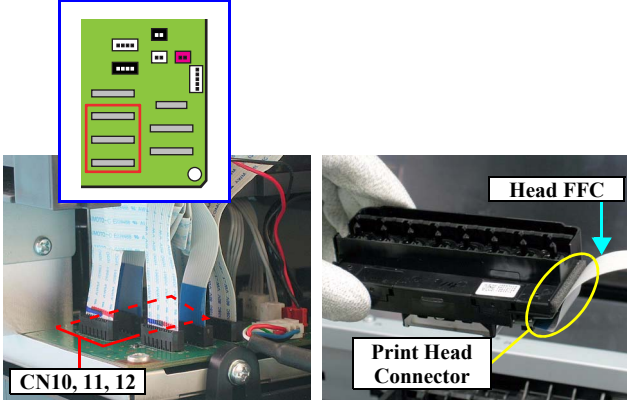
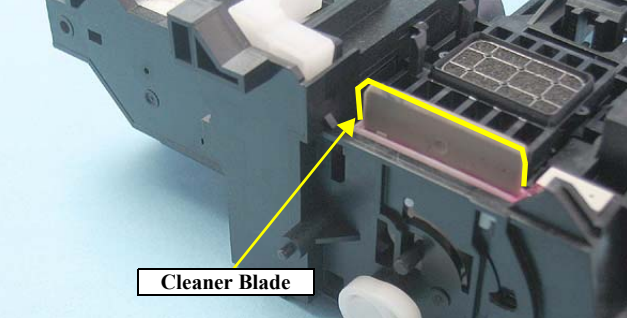
Table 3-12. Print Quality Troubles

Observed Faults	Details of the Fault	Faulty Part/ Part Name	Check Point	Remedy
Vertical or horizontal banding / Color shading	When printing at 360 dpi, horizontal banding and color unevenness appears at a constant frequency.	Adjustment	1. Check that PF Adjustment has executed properly. 2. Check for Dot missing.	1. Perform PF Adjustment properly. Refer to Chapter 5 "ADJUSTMENT". 2. Replace the Ink System Unit with a new one.
	Star Wheel Rollers traces appear in the CR moving direction. 	Paper EJ Frame Assy.	1. Check that the Star Wheel Units have not come off or the Star Wheel Rollers turns normally. 	1. Install the Star Wheel Units to the Paper EJ Frame Assy correctly.
	Printout is faint or blurry.	Printer Driver and the Paper Print Head	1. Check that adequate paper is used according to the setting of the Printer Driver. 1. Using the Adjustment Program, check that the correct Head ID has been written to the EEPROM.	1. Use the appropriate type of paper in accordance with the Printer Driver. 1. Using the Adjustment Program, enter the 31-digit code of the Head ID to the EEPROM. Refer to Chapter 5 "ADJUSTMENT".
	The bottom of the printout is not evenly colored.	Adjustment	1. Check if the Positioning Adjustment of PF Roller Shaft Retainer has been performed properly.	1. Make adjustments according to the specified adjustment priority. Refer to Chapter 5 "ADJUSTMENT".
Paper EJ Roller traces appear on the printout.	Traces of the Paper EJ Roller appear on the printed paper or CD-R*.	Printer Driver and the Paper	1. Check if appropriate paper is used in accordance with the Printer Driver settings.	1. Use the appropriate type of paper in accordance with the Printer Driver.
		Front and Rear Paper EJ Roller Assys.	1. Check if the Paper EJ Roller is clean or not.	1. Clean the Paper EJ Roller using the Roller Cleaning Mode.

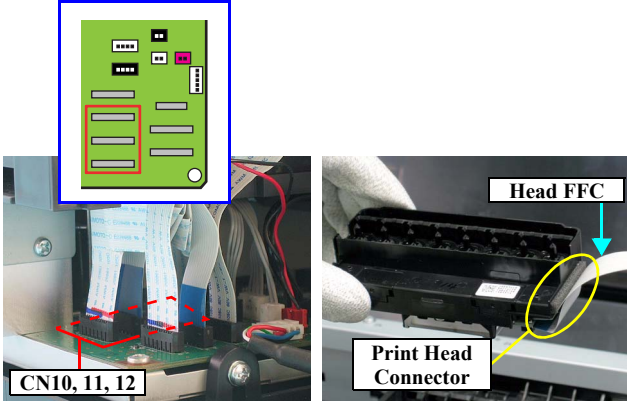
Table 3-12. Print Quality Troubles

Observed Faults	Details of the Fault	Faulty Part/ Part Name	Check Point	Remedy
The printout is stained with ink.	The non-printed side or the bottom of the printout is dirty with ink.	Front Paper Guide Pad	1. Check if the Front Paper Guide Pad is installed securely and evenly in the setting position. 	1. If the Ink pads are not securely installed, reinstall the Front Paper Guide Pad correctly.
	When the paper size in the sent print data is larger than the size of the fed paper, data is printed on the Front Paper Guide, extending off the paper.	PW sensor	1. Check that the PW Sensor FFC is connected. 2. Check that the PW Sensor is not faulty.	1. Connect the PW Sensor FFC. 2. Replace the PW Sensor with a new one.
	Ink smudges appear on the blank area of the printout.	Paper EJ Frame Assy.	1. Check the Star Wheel Rollers for ink stain.	1. Clean the Star Wheel Rollers with a soft cloth.
		Front Paper Guide	1. Check the Front Paper Guide for ink stain.	1. Clean the Front Paper Guide with a soft cloth.

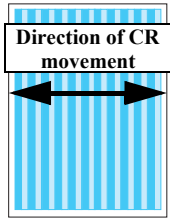
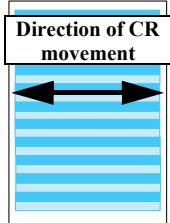
Table 3-12. Print Quality Troubles

Observed Faults	Details of the Fault	Faulty Part/ Part Name	Check Point	Remedy
<p>The printout is stained with ink.</p>	<p>Ink smudges appear on the blank area of the printout.</p>	<p>Front and Rear Paper EJ Roller Assys</p>	<p>1. Check the Front and Rear Paper EJ Roller Assys for ink stain.</p> 	<p>1. Clean the Front and Rear Paper EJ Roller Assys with a soft cloth.</p>
		<p>Driven Roller Shaft</p>	<p>1. Check the Driven Roller Shaft for ink stain.</p>	<p>1. Clean the Driven Roller Shaft with a soft cloth.</p>
		<p>Ink System Unit</p>	<p>1. Check that wiping operation was performed properly.</p> 	<p>1. Install the Cleaner blade correctly or replace it with a new one.</p>

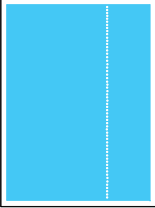
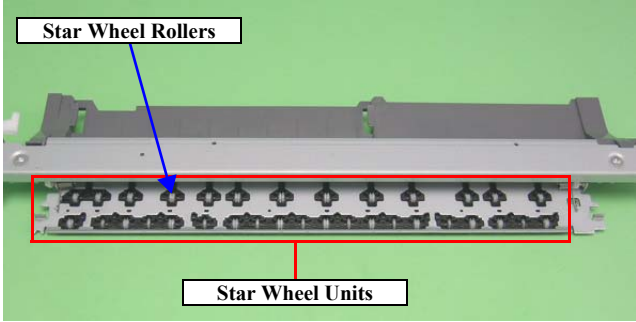
Table 3-12. Print Quality Troubles

Observed Faults	Details of the Fault	Faulty Part/ Part Name	Check Point	Remedy
The printout is stained with ink.	Ink smudges appear on the blank area of the printout.	PF Roller Shaft	1. Check the PF Roller Shaft for ink stain. 	1. Clean the PF Roller Shaft with a soft cloth.
The printout is grainy.	Images are printed grainy in all print modes. Or the image looks rough.	Adjustment Main Board Print Head	1. Check that PG, Bi-D and Head Angular Adjustments have been made properly. 2. Print the adjustment check patterns and check if they are grainy.	1. Make the adjustments according to the specified adjustment priority. Refer to Chapter 5 " ADJUSTMENT ". 2. If the images look still grainy after adjustment, replace the Main Board with a new one.
	When printed at 5760 dpi, the printed images are poor or grainy.	Adjustment Main Board Print Head	1. After making sure that PG, Bi-D and Head Angular Adjustments have been made correctly, check whether PW Sensor has been adjusted properly. 2. Print the adjustment check patterns and check if the printed images are still poor or grainy.	1. Make the adjustment according to the specified adjustment priority. Refer to Chapter 5 " ADJUSTMENT ". 2. If the image quality does not improve after the adjustment, replace the Print Head and Main Board in this order, and check the image graininess.
Regarding hue of images	The whole image is reddish.	Adjustment Print Head	1. Check if the PG has been adjusted properly.	1. Make the adjustment according to the specified adjustment priority. Refer to Chapter 5 " ADJUSTMENT ".
			2. Check that Bi-D and Head Angular Adjustments have been made properly.	2. Make the adjustments according to the specified adjustment priority. Refer to Chapter 5 " ADJUSTMENT ".
			3. Print the adjustment check patterns and check the image color.	3. If the image color does not change after adjustment, replace the Print Head with a new one.

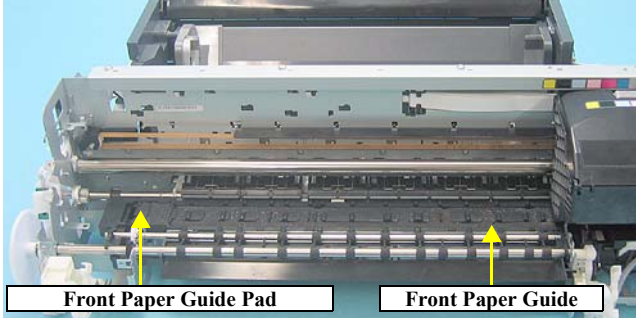
Table 3-12. Print Quality Troubles

Observed Faults	Details of the Fault	Faulty Part/ Part Name	Check Point	Remedy
Borderless Printing	Cannot make a borderless printing (The printer prints with margins despite the borderless setting).	PW sensor	1. Check if the paper dust or scrap of the paper is attached to the Front Paper Guide.	1. Remove the paper dust or scrap of the paper.
			2. Check that the PW Sensor is operating normally. Print the adjustment check patterns with the Adjustment Program, and check that the clip function is executed normally. (It is judged that the clip function is executed normally if an about 5mm margin is provided on the left of the first gray band pattern in the patterns.)	2. If it is judged that the clip function is not executed normally, replace the PW sensor with a new one. Refer to Chapter 5 " <i>ADJUSTMENT</i> ".

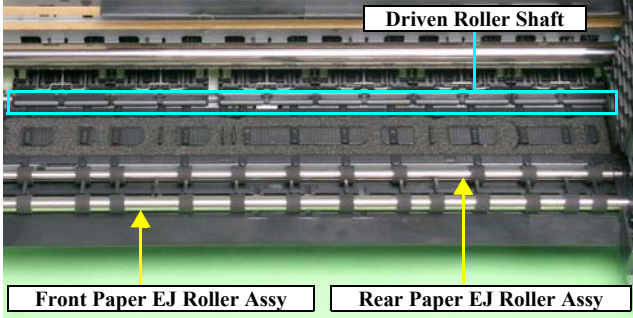
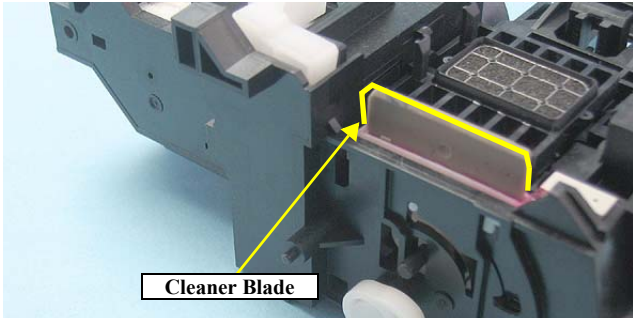
Table 3-13. Abnormal Noise

Occurrence Timing	Details of the Fault	Faulty Part/ Part Name	Check Point	Remedy
-	Printing operation is performed normally but abnormal noise is produced at power-on or during operations.	Adjustment	1. Check that PF Belt Tension Adjustment has been executed properly.	1. Make the adjustment according to the specified adjustment priority. Refer to Chapter 5 " <i>ADJUSTMENT</i> ".
		Carriage Shaft	1. Check that the Carriage Shaft is fully lubricated with grease.	1. Wipe the grease applied to the Carriage Shaft with a dry, soft cloth, and then apply grease (G-71). Refer to Chapter 6 " <i>ADJUSTMENT</i> ".

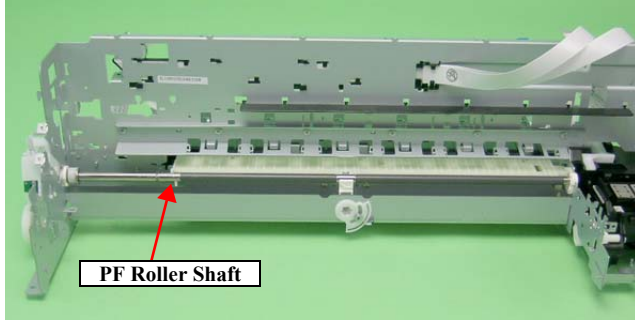
CHAPTER

4

DISASSEMBLY AND ASSEMBLY

4.1 Overview

This chapter describes procedures for disassembling and assembling EPSON Stylus Photo 1390/1400/1410. Unless otherwise specified, disassembled units are reassembled by following the procedures in reverse order.

- **WARNING**
Procedures that must be followed to avoid injury or loss of life.
- **CAUTION**
Procedures that must be followed to avoid damaging the printer or test equipment.
- **CHECK POINT**
Emphasize a particularly important process or procedure.
- **REASSEMBLY**
Indicated when the assembling procedure differs to simple reverse-assembly.
- **ADJUSTMENT REQUIRED**
Indicated if adjustments need to be carried out to complete the repair.

Refer to the exploded diagrams in the Appendix, when disassembling of any unit or parts that are not described in this chapter.

Always read the precautions described in the next section before starting maintenance/repair.

4.1.1 Precautions

Prior to disassembling/reassembling this product, always read the following “WARNING” and “CAUTION” carefully.



- **Always disconnect the power cable. Working with the power cable plugged in for cases such as voltage measurement, be extremely careful not to get an electric shock, and strictly follow the procedures in this manual.**
- **Wear protective goggles to protect your eyes from ink. If ink gets in your eyes, wash with clean water and see a doctor.**
- **To prevent injury from sharp metal edges, always wear gloves for disassembly and reassembly.**
- **If ink gets on your skin, wash with soap and water. If skin irritation occur, see a doctor.**
- **To protect the microprocessors and circuitry, use static discharge equipment, such as anti-static wrist straps when accessing the internal components.**



- **When transporting this printer, remove all cartridges. Remove Cartridges especially for air transportation, due to reduction of atmospheric pressure likely to cause ink leakage.**
- **Use only the recommended tools for disassembly, reassembly and adjustment.**
Refer to **Table 4-1 “List of Tools”**.
- **Tighten screws to the specified torques.**
- **Carry out required adjustments.**
Refer to **“ADJUSTMENT” on page 131**.
- **Use the specified lubricants and adhesives.**
Refer to **“MAINTENANCE” on page 148**.
- **When using compressed air products; such as air duster, for cleaning during repair and maintenance, the use of such products containing flammable gas is prohibited.**

4.1.2 Tools

The following table indicates the tools recommended for disassembly/assembly. All are commercially available, and should be ready beforehand.

Table 4-1. List of Tools

Tool Name	Tool Code
Phillips Screw Driver, No.1	1080530
Phillips Screw Driver, No.2	1080532
Flat-blade Screwdriver	1080527
Tweezers	1080561
Needle nose pliers	1080564
Acetate Tape	1003963
PF Tension Measuring Tool	1231678
Penlight	---

4.1.3 Screws

The following table lists the screws used in this product. When disassembling and reassembling the printer, refer to the following table and use the specified screws in the specified positions.

Table 4-2. List of Screw Types

Image	Description	Image	Description
	1) C.B.P. 3x10		2) C.B.S. 3x6
	3) C.B.S. (P2) 3x10		4) C.B.P. 3x8
	5) C.B.S. 3x8		6) C.B.S. (P4) 3x8
	7) C.B.P. 2.6x8		8) C.B.S. (P4) 3x6
	9) C.B.P. 3x6		10) C.B.S. 3x4
	11) C.C. 3x4		12) C.P.B. (P1) 1.7x5
	13) C.B.P. 2.6x5		14) C.P.S. 3x10
	15) C.B.P. 3x10		

4.1.4 Work Completion Checklist

Whenever the printer is serviced, use the checklist shown below to confirm all work is completed properly and the printer is ready to be returned to the user.

Classification	Item	Check Point	Check Field
Main Unit	Self-test	Is the operation normal?	<input type="checkbox"/> Checked / <input type="checkbox"/> Not necessary
	On-line Test	Is the printing attempt successful?	<input type="checkbox"/> Checked / <input type="checkbox"/> Not necessary
	Print Head	Is ink discharged normally from all the nozzles?	<input type="checkbox"/> Checked / <input type="checkbox"/> Not necessary
	Carriage Mechanism	Does it move smoothly?	<input type="checkbox"/> Checked / <input type="checkbox"/> Not necessary
		Any abnormal noise during the operation?	<input type="checkbox"/> Checked / <input type="checkbox"/> Not necessary
		Are there any dirt or foreign objects on the CR Shaft?	<input type="checkbox"/> Checked / <input type="checkbox"/> Not necessary
		Is the CR Motor at the correct temperature? (Not too hot to touch?)	<input type="checkbox"/> Checked / <input type="checkbox"/> Not necessary
	Paper Feeding Mechanism	Is paper advanced smoothly?	<input type="checkbox"/> Checked / <input type="checkbox"/> Not necessary
		No paper jamming?	<input type="checkbox"/> Checked / <input type="checkbox"/> Not necessary
		No paper skew?	<input type="checkbox"/> Checked / <input type="checkbox"/> Not necessary
		No multiple-sheet feeding?	<input type="checkbox"/> Checked / <input type="checkbox"/> Not necessary
		Is the PF Motor at correct temperature? (Not too hot to touch?)	<input type="checkbox"/> Checked / <input type="checkbox"/> Not necessary
		Any abnormal noise?	<input type="checkbox"/> Checked / <input type="checkbox"/> Not necessary
	Is the paper path free of obstructions?	<input type="checkbox"/> Checked / <input type="checkbox"/> Not necessary	
Adjustment	Specified Adjustment	Are all the adjustments correctly completed?	<input type="checkbox"/> Checked / <input type="checkbox"/> Not necessary
Lubrication	Specified Lubrication	Has lubrication been applied at the specified points?	<input type="checkbox"/> Checked / <input type="checkbox"/> Not necessary
		Is the amount of lubrication correct?	<input type="checkbox"/> Checked / <input type="checkbox"/> Not necessary
Function	ROM Version	Version: _____	<input type="checkbox"/> Checked / <input type="checkbox"/> Not necessary
Packing	Ink Cartridge	Have the ink cartridges been removed?	<input type="checkbox"/> Checked / <input type="checkbox"/> Not necessary
	Protective Materials	Have all relevant protective materials been attached to the printer?	<input type="checkbox"/> Checked / <input type="checkbox"/> Not necessary
Others	CD/DVD Tray*	Is the operation normal?	<input type="checkbox"/> Checked / <input type="checkbox"/> Not necessary
	Accessories	Have all the accessories sent by the user been included in the package?	<input type="checkbox"/> Checked / <input type="checkbox"/> Not necessary

Note *: Stylus Photo 1390 does not have the CD/DVD Tray.

4.1.5 Sharp Metal Edges



During disassembly/reassembly of the Stylus Photo 1390/1400/1410, extra care must be taken to avoid injury from sharp metal edges, especially from the edges shown below.

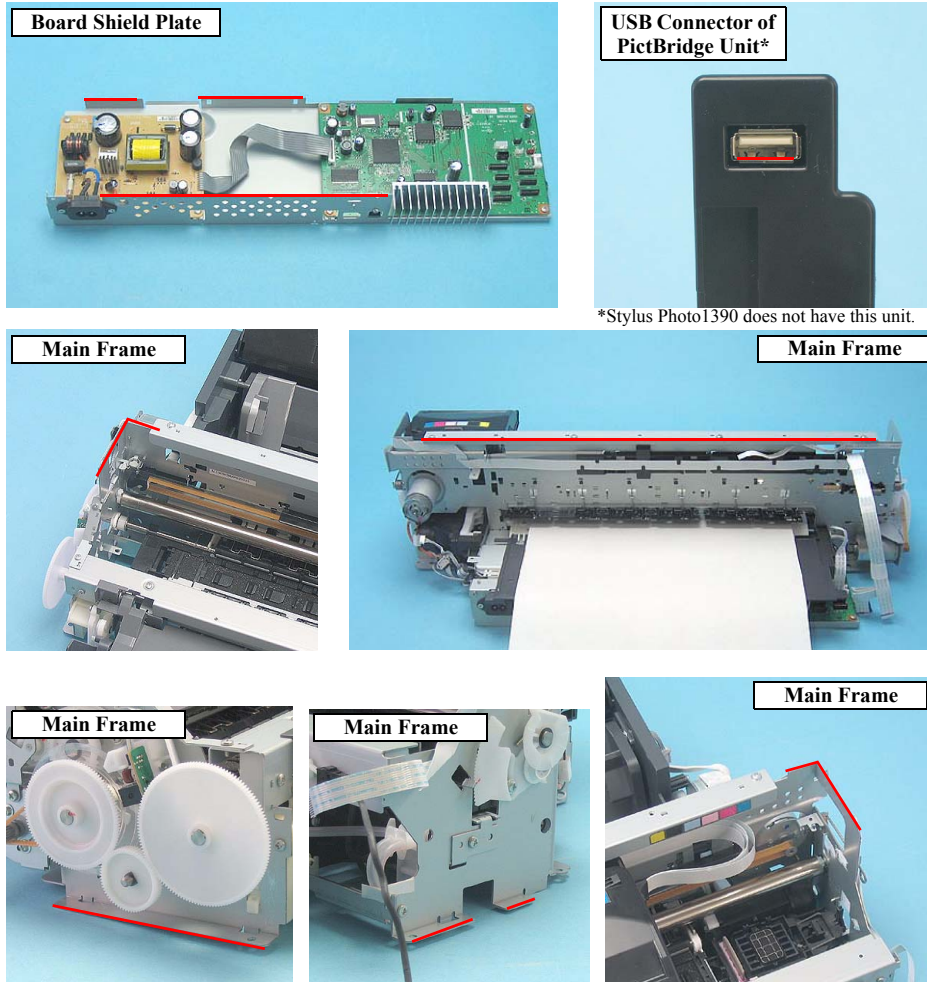

Figure 4-1. Parts with Sharp Metal Edges

4.1.6 Method for making CSIC board removal tool

The CSIC board (refer to p94) can be easily removed by using a special tool. The method for making the tool is described below.

1. Prepare a handle part of a clip, or a similar metal wire piece.

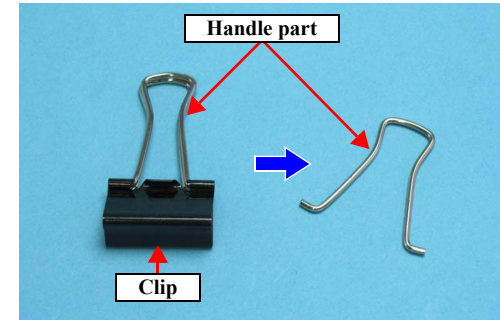

Figure 4-2. Method for making CSIC Board Removal Tool (1)

2. Bend the metal wire into dimensions described below.

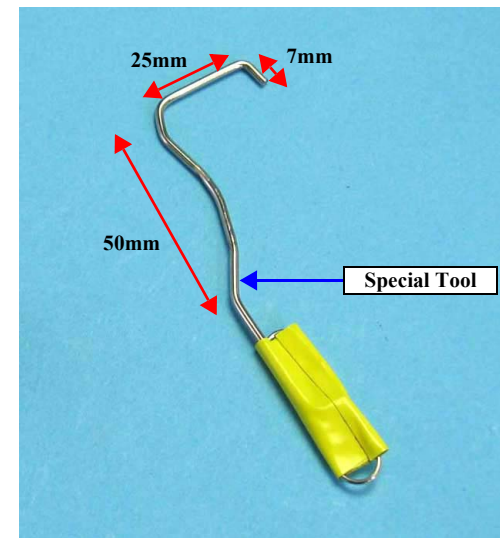
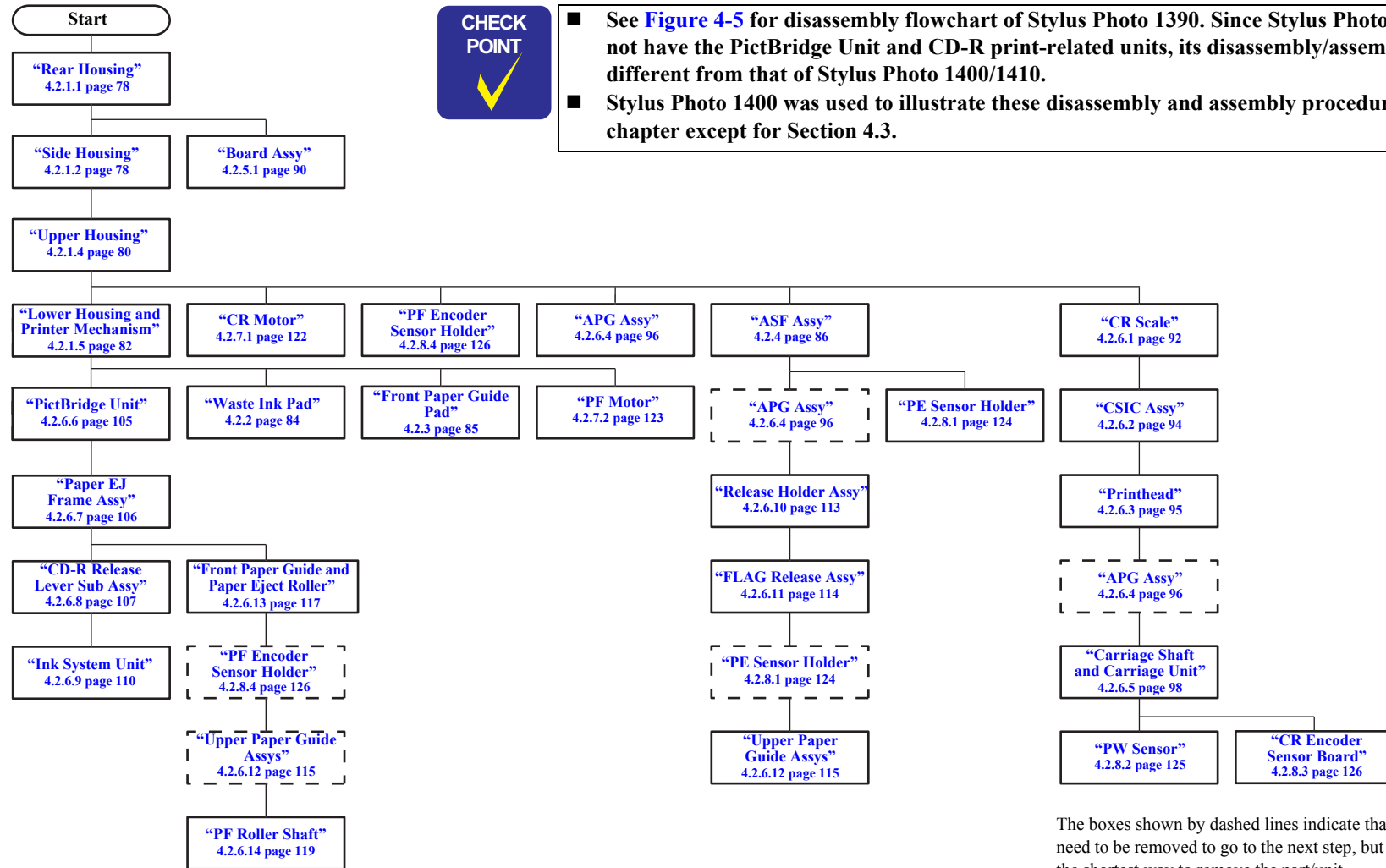

Figure 4-3. Method for making CSIC Board Removal Tool (2)

4.2 Disassembly/Assembly Procedures

The following flowcharts show the step-by-step disassembly procedures. When disassembling each unit, refer to the page number shown in the figure.

Stylus Photo 1400/1410



- See [Figure 4-5](#) for disassembly flowchart of Stylus Photo 1390. Since Stylus Photo 1390 does not have the PictBridge Unit and CD-R print-related units, its disassembly/assembly flow is different from that of Stylus Photo 1400/1410.
- Stylus Photo 1400 was used to illustrate these disassembly and assembly procedures in this chapter except for Section 4.3.

The boxes shown by dashed lines indicate that the part/unit need to be removed to go to the next step, but does not indicate the shortest way to remove the part/unit.

Figure 4-4. Disassembly Flowchart of Stylus Photo 1400/1410

Stylus Photo 1390

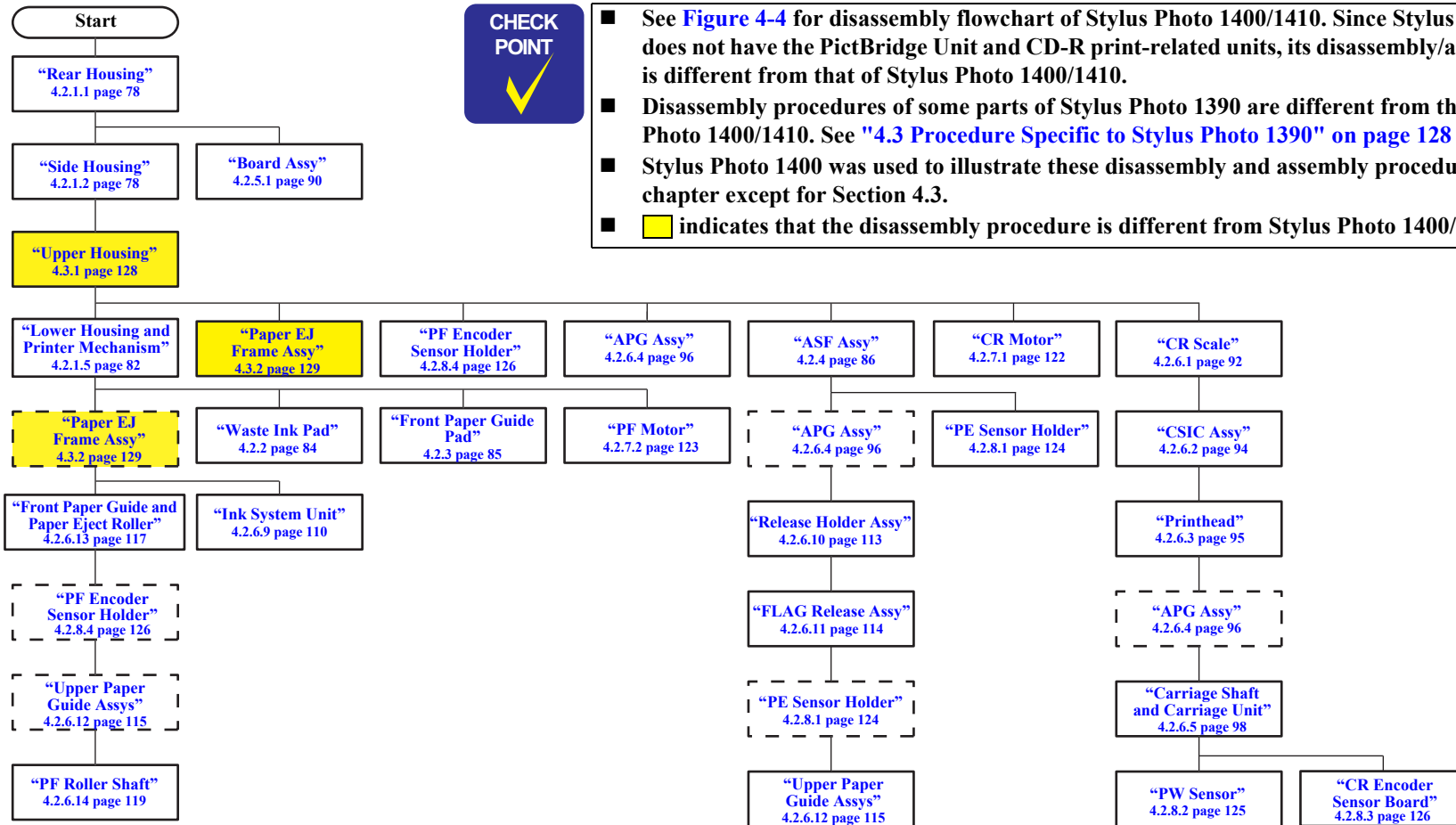

- See [Figure 4-4](#) for disassembly flowchart of Stylus Photo 1400/1410. Since Stylus Photo 1390 does not have the PictBridge Unit and CD-R print-related units, its disassembly/assembly flow is different from that of Stylus Photo 1400/1410.
- Disassembly procedures of some parts of Stylus Photo 1390 are different from those of Stylus Photo 1400/1410. See "[4.3 Procedure Specific to Stylus Photo 1390](#)" on page 128 for details.
- Stylus Photo 1400 was used to illustrate these disassembly and assembly procedures in this chapter except for Section 4.3.
- indicates that the disassembly procedure is different from Stylus Photo 1400/1410.

The boxes shown by dashed lines indicate that the part/unit need to be removed to go to the next step, but does not indicate the shortest way to remove the part/unit.

Figure 4-5. Disassembly Flowchart of Stylus Photo 1390

4.2.1 Removing the Housings

4.2.1.1 Rear Housing

1. Remove the IEEE Cover like opening it from the left.
2. Remove the four C.B.P. 3x10 screws and the C.B.S. 3x6 screw that secure the Rear Housing, and remove the Rear Housing.

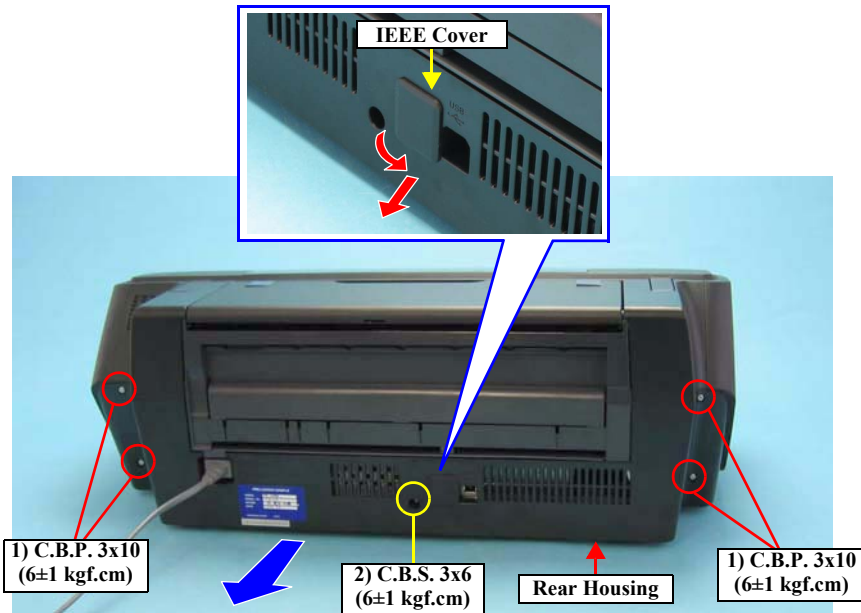

Figure 4-6. Removing the Rear Housing



Install the IEEE Cover to the Rear Housing, facing the side of the rib to the right.



Figure 4-7. Installing the IEEE Cover

4.2.1.2 Side Housing

1. Remove the Rear Housing. See Section 4.2.1.1 on page 78.
2. Insert a flat-blade screwdriver into the cutouts of the Lower Housing, and lift it in the direction of the arrow to remove the Left Side Housing releasing the two tabs. Remove the Right Side Housing in the same way.

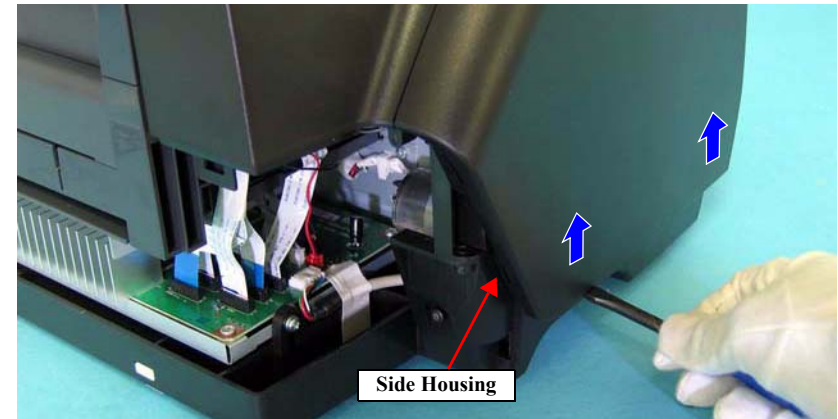

Figure 4-8. Removing the Side Housing



Match the positioning holes of the Upper Housing with the guide pins of the Side Housing.

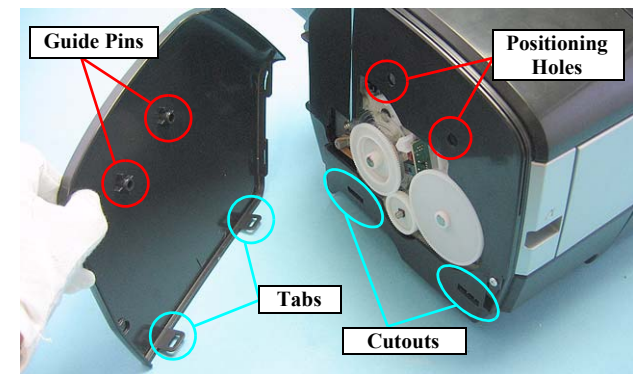

Figure 4-9. Installing the Side Housing

4.2.1.3 Locking/Releasing the Carriage and Opening/Closing the CD-R Unit



If you are servicing Stylus Photo 1390, refer to this section only for locking and releasing the Carriage. Stylus Photo 1390 does not have the CD-R Unit.

Locking/releasing the Carriage and opening/closing the CD-R Unit are mutually related. The CD-R Unit cannot be opened when the Carriage Lock is released.

1. Remove the Right Side Housing. See section 4.2.1.2 on page 78.
2. Insert the flat-blade screwdriver into the hole on the right side of the frame, and rotate the white shaft of the Ink System Unit.

Table 4-3. Relation between Carriage Lock and CD-R Unit

Direction of Rotation	Carriage	CD-R Unit
Clockwise (CW)	Locked	Can be opened/closed.
Counterclockwise (CCW)	Released	Locked

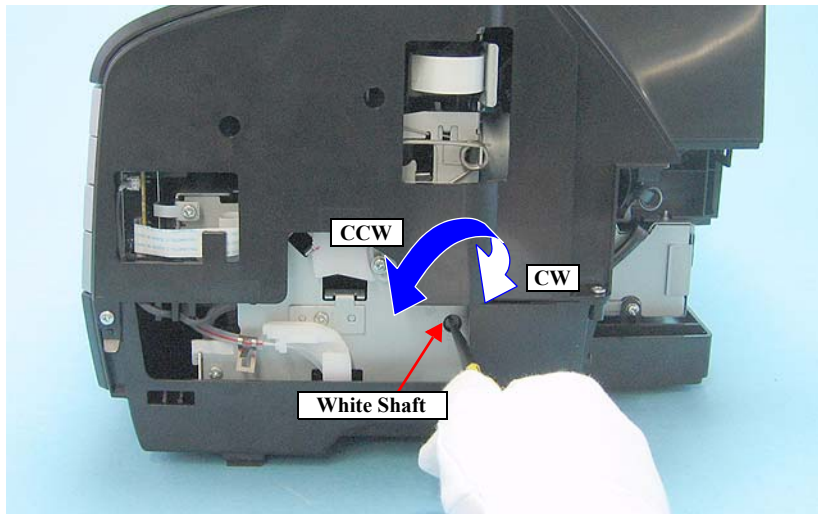

Figure 4-10. Locking/Releasing the Carriage and Opening/Closing the CD-R Unit



When moving the Carriage Unit with the CD-R Unit opened, turn the PG CAM (Right) beforehand so that PG ++ points downwards to release the PG in order to prevent interference between the Paper EJ Frame and Carriage Unit.

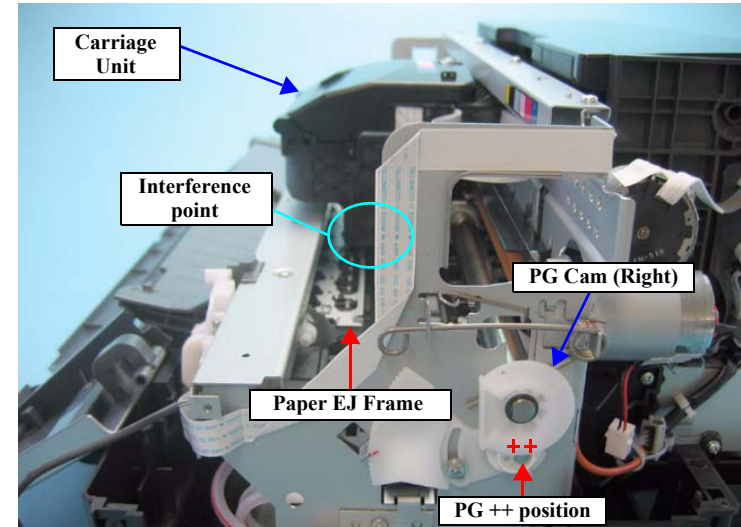

Figure 4-11. Interference between the Frame and Carriage Unit

4.2.1.4 Upper Housing



See "4.3.1 Upper Housing" on page 128 to remove the Upper Housing of the Stylus Photo 1390.

1. Remove the Side Housing. See Section 4.2.1.2 on page 78.
2. Open the Printer Cover and Paper Support.
3. Open the Front Cover. See section 4.2.1.3 on page 79.
4. Remove the four C.B.P. 3x10 screws, three C.B.S. 3x6 screws, and two C.B.P. 3x10 screws that secure the Upper Housing.

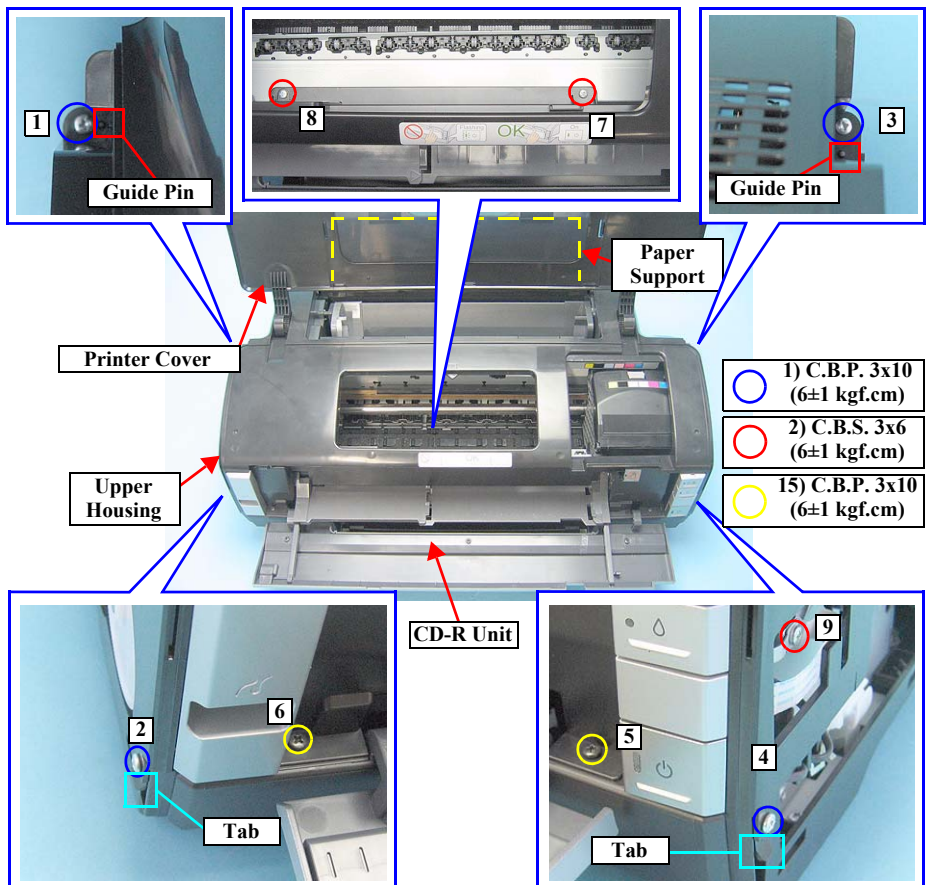

Figure 4-12. Screws that Secure the Upper Housing

5. Disconnect the Panel FFC and CD-R Sensor Cable from connectors CN1 and CN2 on the Switch Board, and release the CD-R Sensor Cable from the tabs of the Upper Housing.

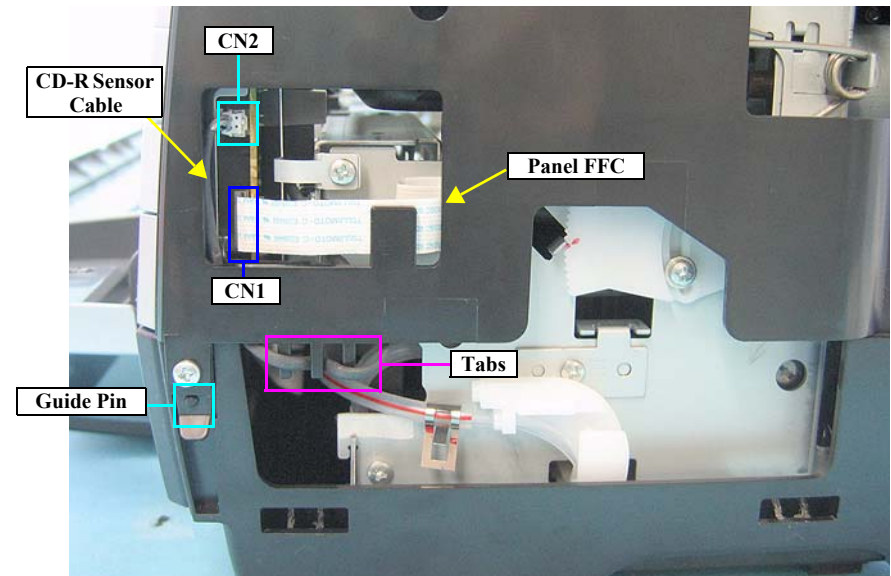

Figure 4-13. Disconnecting the CD-R Sensor Cable and Panel FFC

6. Remove the Guide Pins from the two tabs shown in Figure 4-12, and remove the Upper Housing upwards.



- Align the Guide Pins with the positioning holes of the Upper Housing. See Figure 4-12.
- When inserting the CD-R Sensor Cable into the Switch Board, press the connector to make sure that it is firmly installed on the Switch Board.
- Referring to Figure 4-13, correctly route the Panel FFC and CD-R Sensor Cable.
- Tighten the screws in the order shown in Figure 4-12.

PRINTER COVER

1. Remove the two C.B.P. 3x8 screws that secure the Left Printer Cover Holder, and draw it out in the direction of the arrow.
Remove the Right Printer Cover Holder in the same way.

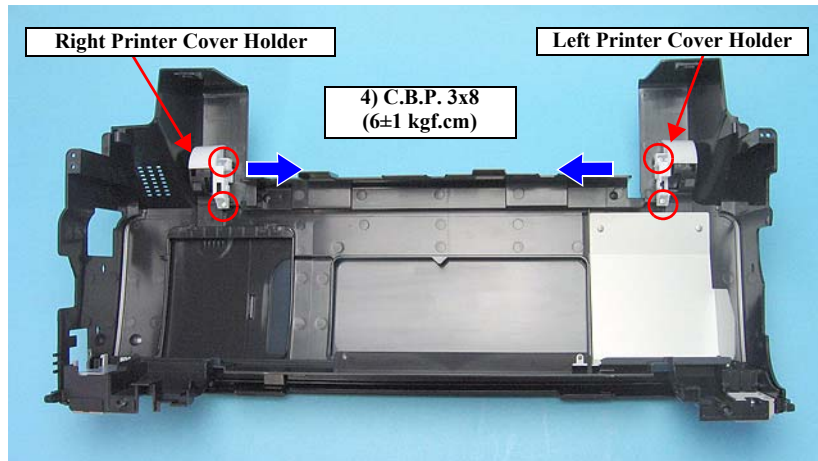

Figure 4-14. Removing the Printer Cover Holder

2. Lift the Upper Housing in the direction of the arrows, pull the Guide Pin on the Upper Housing away from the cutout on the Printer Cover, and remove the Printer Cover.

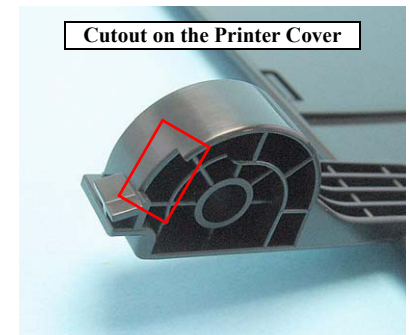
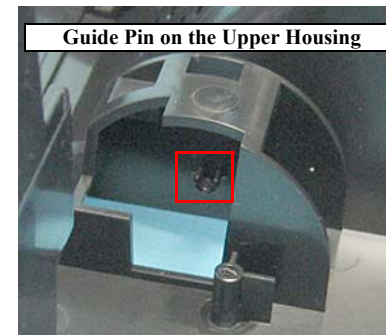
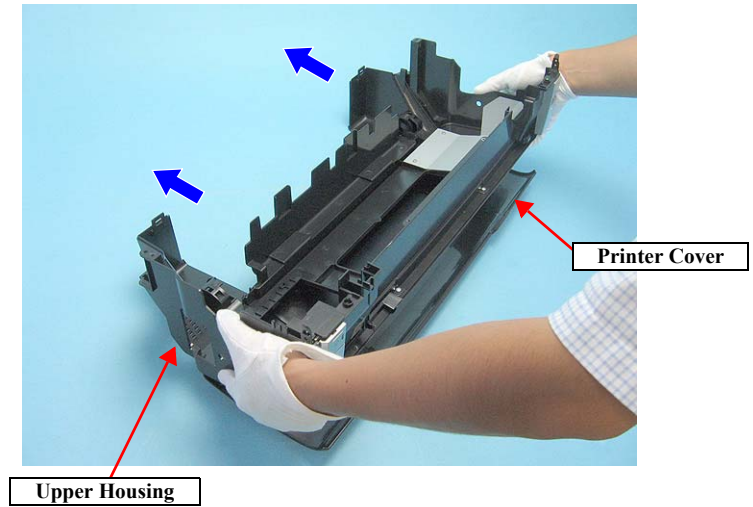

Figure 4-15. Removing the Printer Cover

4.2.1.5 Lower Housing and Printer Mechanism

1. Remove the Upper Housing.
For Stylus Photo 1400/1410: See section 4.2.1.4 on page 80.
For Stylus Photo 1390: See section 4.3.1 on page 128.
2. Grip both ends of the Ink Tube Fastener with your fingers, slide it in the direction of the arrow, and draw out the Waste Ink Tube from the Ink Tube.
3. Remove the acetate tape that secure the PictBridge Unit Connector Cable to the Lower Housing. (Skip this procedure for Stylus Photo 1390)
4. Remove the four C.B.P. 3x10 screws and two C.B.S. (P2) 3x10 screws that secure the Printer Mechanism.



- See the page given below to check for sharp metal edges before starting maintenance/repair.
 - “Sharp Metal Edges” on page 75.
- Always hold the positions indicated in the figure when handling the Printer Mechanism to avoid deformation of the frames.

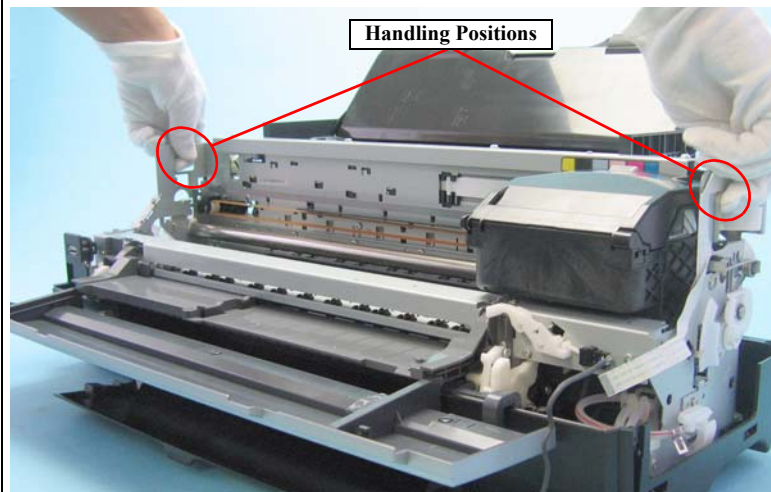

Figure 4-16. Handling of the Printer Mechanism

5. Hold the Printer Mechanism by its handling positions with both hands, and remove it from the Lower Housing.

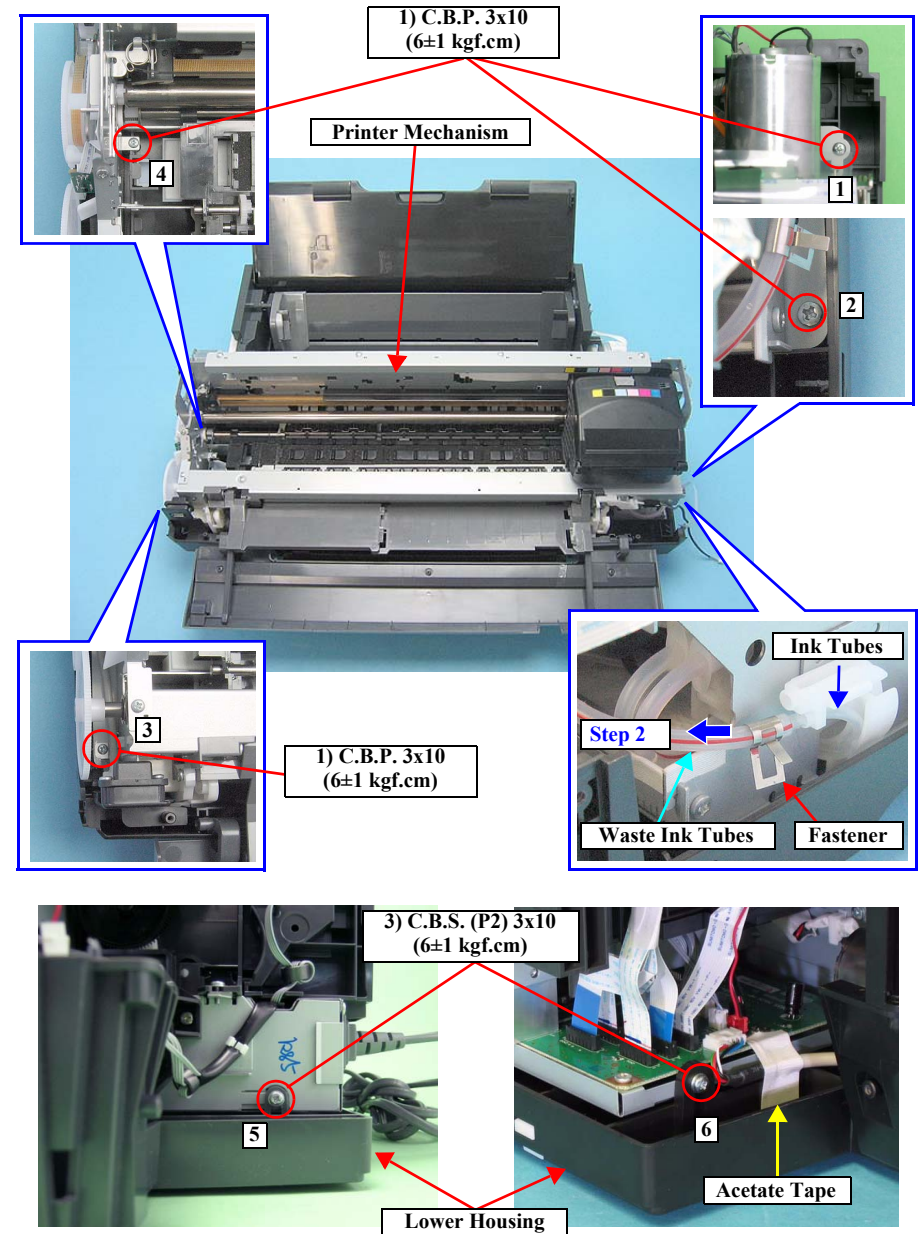

Figure 4-17. Screws that Secure the Printer Mechanism



- Insert the Waste Ink Tube with the red line into the Ink Tube.

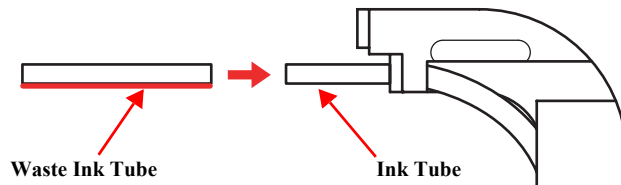

Figure 4-18. Installing the Ink Tubes

- Make sure that the Waste Ink Tubes are not nipped by the Printer Mechanism.
- Tighten the screws in the order shown in [Figure 4-17](#).
- Secure the bracket of the PictBridge and the Printer Mechanism together with screw [3](#).

The following three reassembly instructions does not apply to Stylus Photo 1390:

- When installing the Printer Mechanism, match the positioning hole of the PictBridge Unit to the dowel of the Lower Housing.

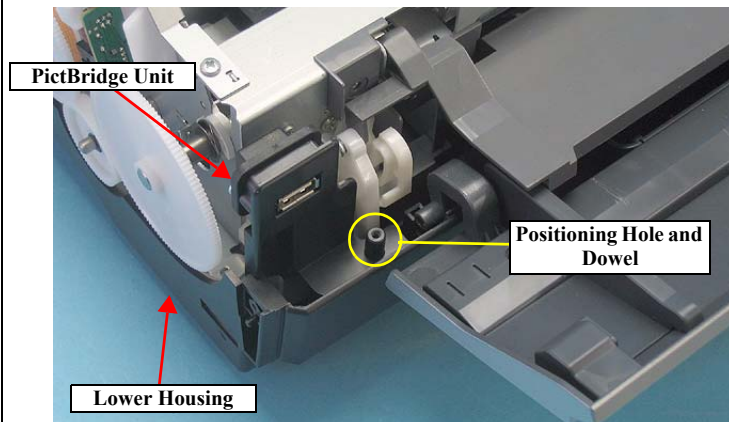

Figure 4-19. Installing the Printer Mechanism (1)



- When installing the Printer Mechanism, check that the PictBridge Unit cable is secured to the Main Frame with Acetate tape, and be careful not to pinch it. (For Acetate Tape position of the PictBridge Unit cable, refer to ["PictBridge Unit" on page 105](#).)
- Fix the PictBridge Unit cable to the Lower Housing with acetate tape as shown below.
 - Left edge: Align with the right edge of CN2
 - Top edge: Do not cover the chips on the Main board.

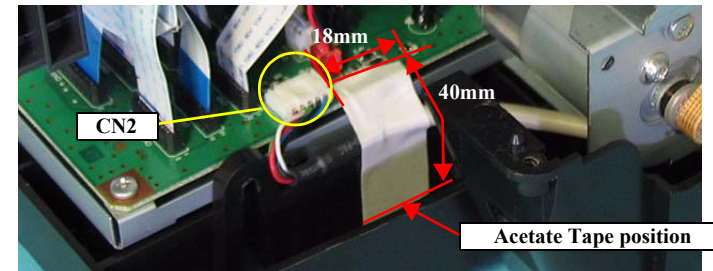

Figure 4-20. Installing the Printer Mechanism (2)



After replacing the Printer Mechanism, be sure to make the following adjustments.

1. Platen Gap (PG) Adjustment ([p.132](#))
 2. Head Angular Adjustment ([p.132](#))
 3. Bi-D Adjustment ([p.132](#))
 4. First dot position ([p.133](#))
 5. PW Sensor Adjustment ([p.133](#))
 6. PF Deterioration Compensation Counter Reset ([p.133](#))
 7. PF Adjustment ([p.133](#))
 8. PF Adjustment (Bottom Margin) ([p.133](#))
 9. CR Motor Drive Dispersion Measurement Sequence ([p.133](#))
- Refer to Chapter 5 "Adjustment" for details on the adjustments.

4.2.2 Waste Ink Pad

1. Remove the Lower Housing. See section 4.2.1.5 on page 82.
2. Remove the C.B.P. 3x8 screw that secures the Waste Ink Tube.
3. Remove the 11 Waste Ink Pads from the Lower Housing.

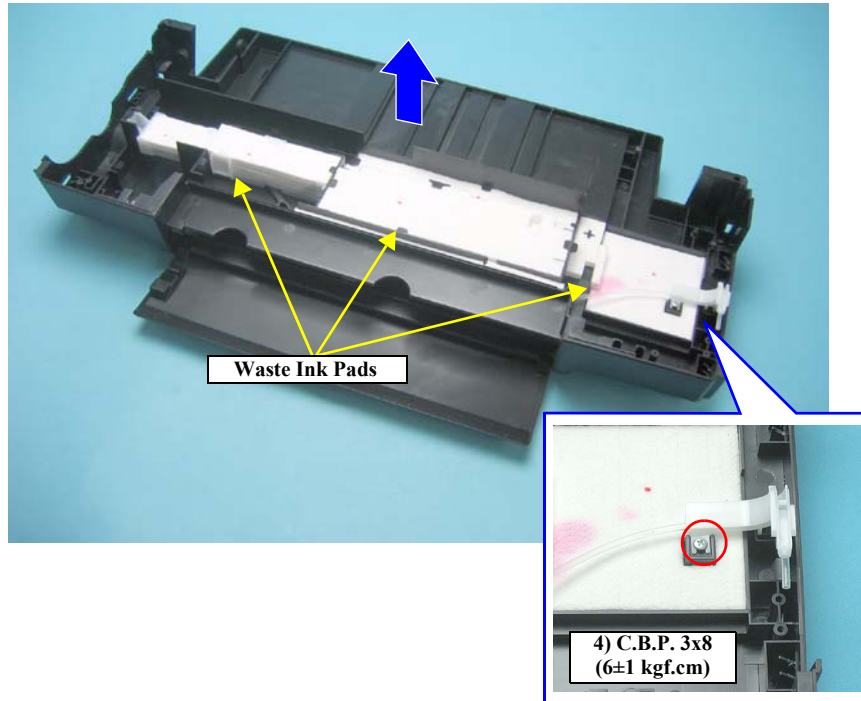

Figure 4-21. Removing the Waste Ink Pads



- Route the Waste Ink Tube as shown below.

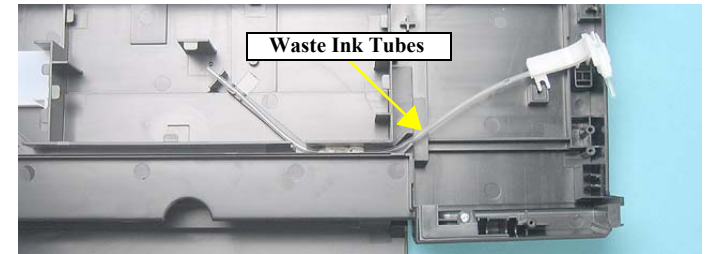

Figure 4-22. Positions of Waste Ink Tubes

- Referring to Figure 4-23, correctly install the Waste Ink Pads.

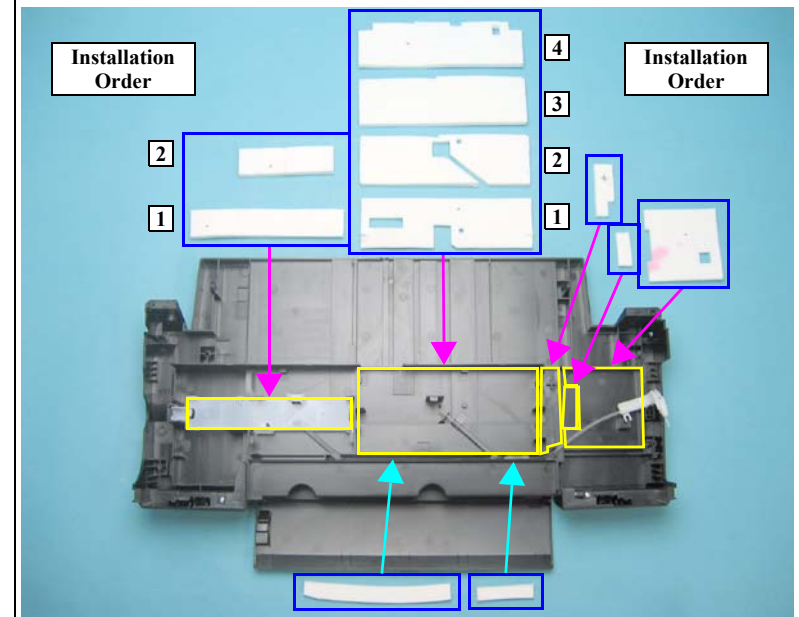

Figure 4-23. Installing the Waste Ink Pads



After replacing or removing the Waste ink Pads, be sure to make the following adjustments.

- Waste Ink Protection Counter Reset (p.134)
Refer to Chapter 5 “Adjustment” for details on the adjustment.

4.2.3 Front Paper Guide Pad

1. Remove the Printer Mechanism. See section 4.2.1.5 on page 82.
2. Remove the Front Paper Guide Pads and Front Paper Guide Pad Protection from the Front Paper Guide with tweezers.

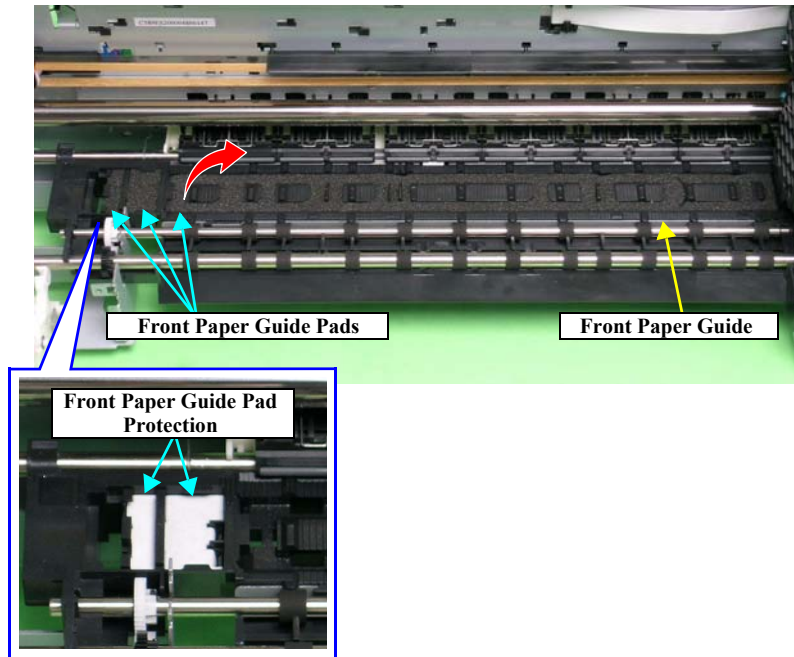

Figure 4-24. Removing the Front Paper Guide Pads and the Front Paper Guide Pad Protection



Make sure that the grease contained in the Front Paper Guide Pads and the Front Paper Guide Pad Protection do not stick to other parts.



After installing the Front Paper Guide Pads and Front Paper Guide Pad Protection, lift the Printer Mechanism, and check the following points.

1. Make sure that the tabs on the Pads are not cut midway.
2. Make sure that all tabs are in place on the Front Paper Guide, and that they are facing down (toward the Waste Ink Pads) without any folds.
3. Make sure that the turned edges of the tabs are protruding completely from the Front Paper Guide.



Figure 4-25. Installing the Front Paper Guide Pad (1)

4. Make sure that the Pad is placed under a tab of the Front Paper Guide.

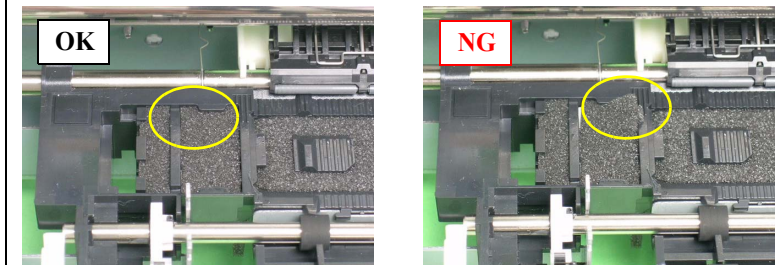

Figure 4-26. Installing the Front Paper Guide Pad (2)

5. Make sure that all the tabs on the Pads are fitted into the securing section under the Front Paper Guide.

4.2.4 ASF Assy

1. Remove the Upper Housing.
For Stylus Photo 1400/1410: See section 4.2.1.4 on page 80.
For Stylus Photo 1390: See section 4.3.1 on page 128.
2. Remove the screw C.B.S. 3x8 that secures the Earth Cables positioned on the right rear side of the printer, and remove the Earth Cables.
3. Disconnect the ASF Motor Connector from the Relay Connector.
4. Disconnect the Relay Connector Cable from the ASF Assy.

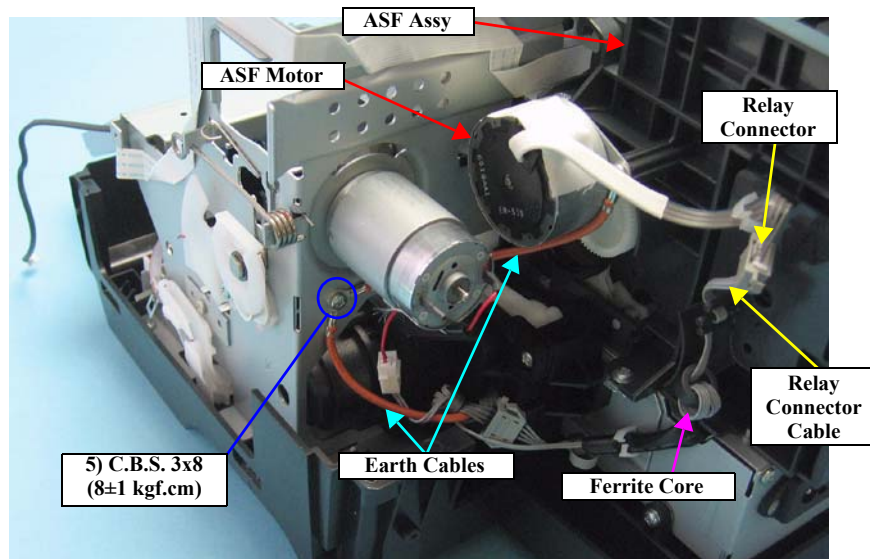

Figure 4-27. Releasing the Cables (1)



- Secure the two Earth Cables together with the screw.
- Referring to Figure 4-27, correctly route the Relay Connector Cable.

5. Disconnect all the Cables and the FFCs from the connectors on the Relay Board.
 - CN1 : Relay FFC
 - CN2 : PE Sensor Cable
 - CN4 : APG Sensor Cable (downside)
 - CN5 : APG Sensor Cable (the upper side)
 - CN6 : PF Encoder Sensor FFC
6. Disconnect the FFC bundled by the Acetate Tape 2 from the connectors (CN5, CN10, CN11, CN12, CN14, CN15) on the Main Board, and release it from the groove of the ASF Assy.
7. Remove the Acetate Tape 2, and disconnect the APG Motor Cable and PE Sensor Cable from the ASF Assy.
8. Peel off the PF Encoder FFC secured by two pieces of double-sided adhesive tape from the ASF Assy.

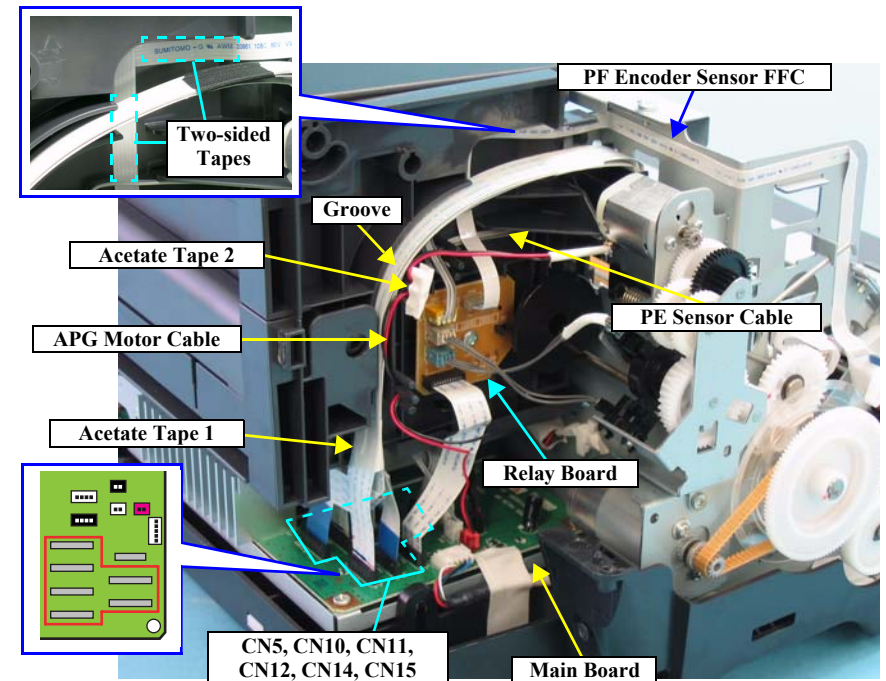

Figure 4-28. Releasing the Cables (2)



- Referring to [Figure 4-28](#), route each of the Cables and FFCs.
- After routing the APG Motor Cable to the rib of the ASF Assy, secure it with the Acetate Tape 2 as shown below.

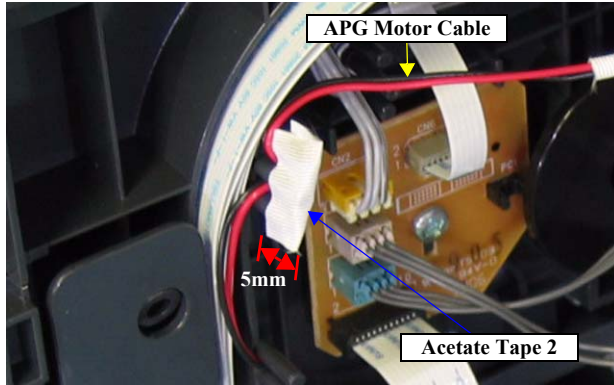

Figure 4-29. Installing the Acetate Tape 2

- When installing the FFC to the connector (CN15), secure it with acetate tape as shown below.

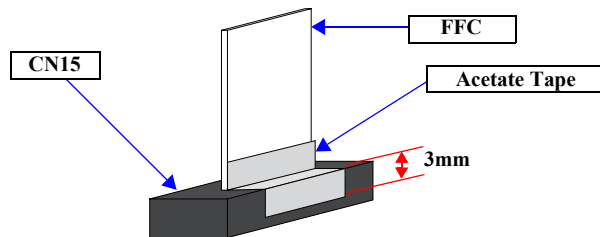

Figure 4-30. Installing the Acetate Tape

9. Remove the two C.B.S. 3x6 screws that secure the two Guide Roller LDs.
10. Gently pull the LD Roller Shaft to the rear of the printer, and remove the Guide Roller LDs.

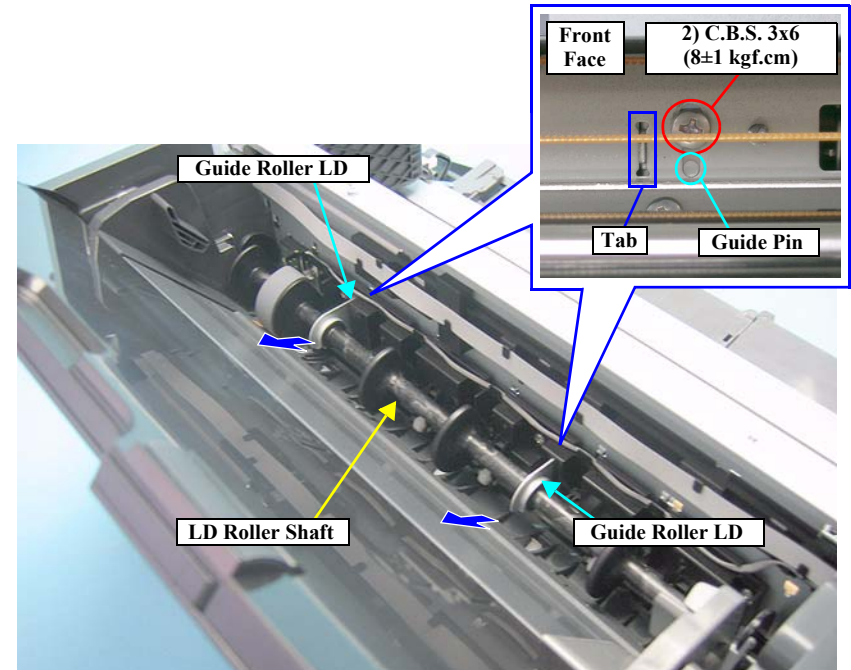

Figure 4-31. Removing the Guide Roller LD



Align the Guide Pins and tabs on the Guide Roller LDs with the positioning holes on the Main Frame. See [Figure 4-31](#).

11. Remove the three C.B.S. (P4) 3x8 screws that secure the ASF Assy, and remove the ASF Assy from the Printer Mechanism.

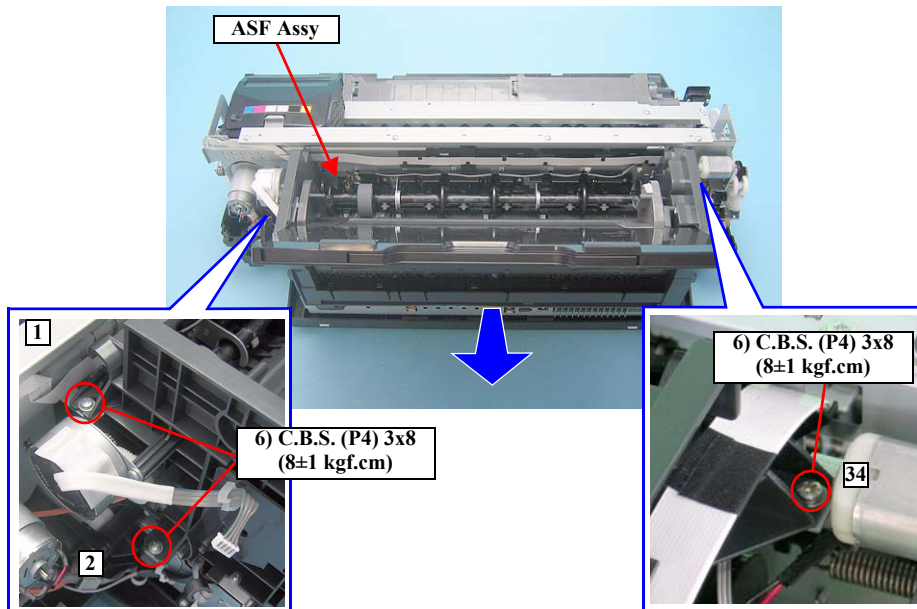

Figure 4-32. Removing the ASF Assy



- Align the Guide Pin and four tabs on the ASF Assy with the positioning holes on the Main Frame so that there is no gap between the ASF Assy and the Main Frame.

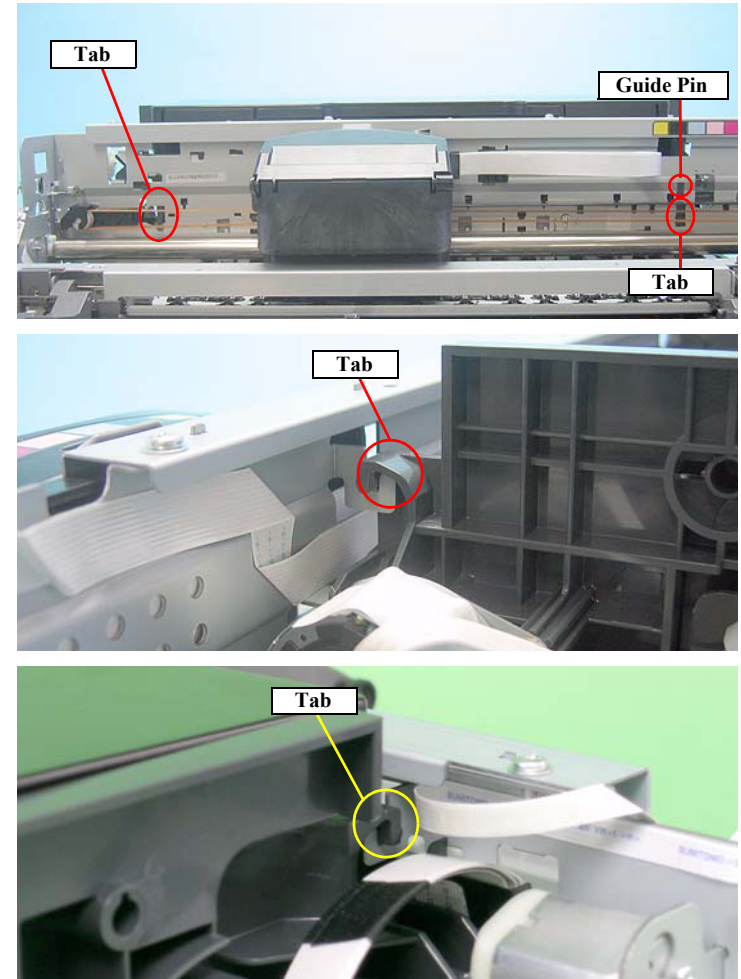

Figure 4-33. Installing the ASF Assy

- Tighten the screws in the order shown in [Figure 4-32](#).



■ **Adjusting the Position of the ASF Guide Roller LDs**
 In order to maintain the paper feed accuracy, when installing the Guide Roller LDs, the position of the Guide Roller LDs must be adjusted so that the positions of the LD Roller Shaft and Retard Roller are optimized.

1. After installing the ASF Assy, loosen the two screws (2) C.B.S. 3x6) that secure the Guide Roller LD. See Figure 4-31.
2. Turn Combination Gear 29.11 on the right side of the ASF Assy CCW to raise the Hopper to the upper limit position (until the Hopper Pad contacts the LD Roller).

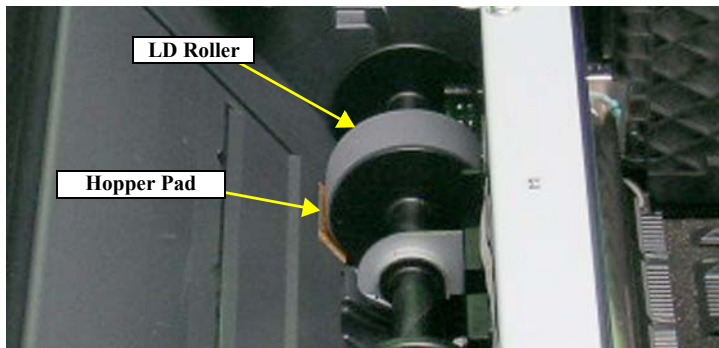

Figure 4-34. Raising the Hopper



3. With a penlight, light through the gap of the ASF Assy to check that the tab on the Retard Roller Holder at the back of the two Reference tabs on the ASF Assy can be seen. After making sure that the two Reference tabs are aligned when viewed edge-on, adjust the position of the Retard Roller Holder tab by pressing the Guide Roller LD (0 digit side) so that it is placed within the range as shown in the simplified diagram below.

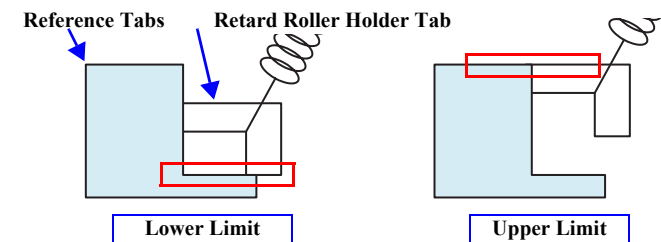
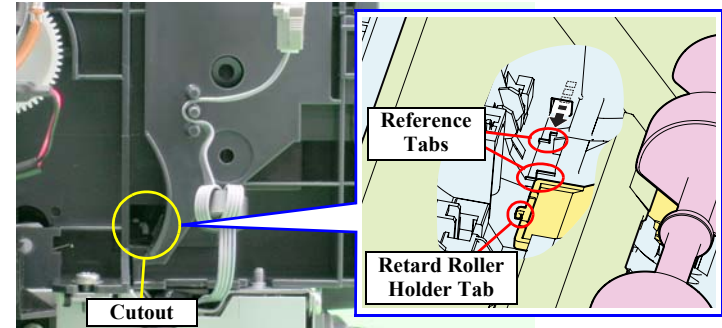
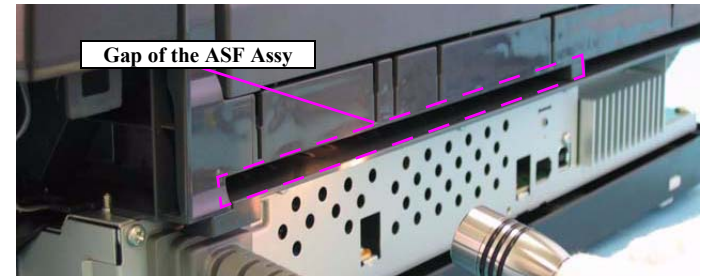

Figure 4-35. Aligning the Position of the Guide Roller LD (0 Digit Side)



4. Align the Guide Pin and the tab on the 0 Digit Side Guide Roller LD with the positioning holes on the Main Frame, and tighten the Guide Roller LD (0 Digit Side) with the screws. See Figure 4-36.
5. Check the position of the Retard Roller Holder tab again through the gap. If it is not inside the range, remove the screws on the Guide Roller LD (0 Digit Side), and repeat steps 2 to 4 to set the tab within the range.
6. Check the clearance in both ends of the positioning hole that the Guide Roller LD tab is inserted, and align Guide Roller LD (130 Digit Side) to the same height, and tighten with the screws.

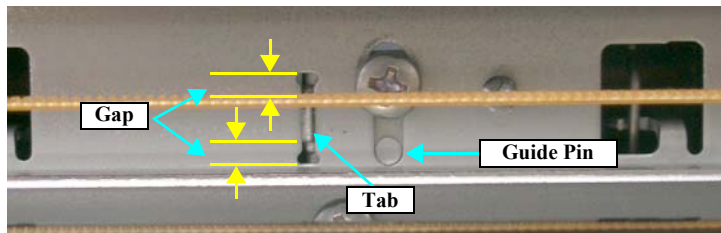

Figure 4-36. Checking the Position of Tab on the Guide Roller LD

Table 4-4. Trouble Caused by Setting Mistakes

Tab Position	Trouble
Over the upper limit	• Paper feeding problems caused by non-feed
Under the lower limit	• Multiple-sheet feeding



After replacing or removing the ASF Assy, always make the following adjustment.

- First dot position (p.133)

Refer to Chapter 5 “Adjustment” for details on the adjustments.

4.2.5 Removing the Boards

4.2.5.1 Board Assy

1. Remove the Rear Housing. See Section 4.2.1.1 on page 78.
2. Remove the four screws (2) C.B.S. 3x6, two screws (3) C.B.S. (P2) 3x10, and the screw (14) C.P.S. 3x10 that secure the Board Assy.

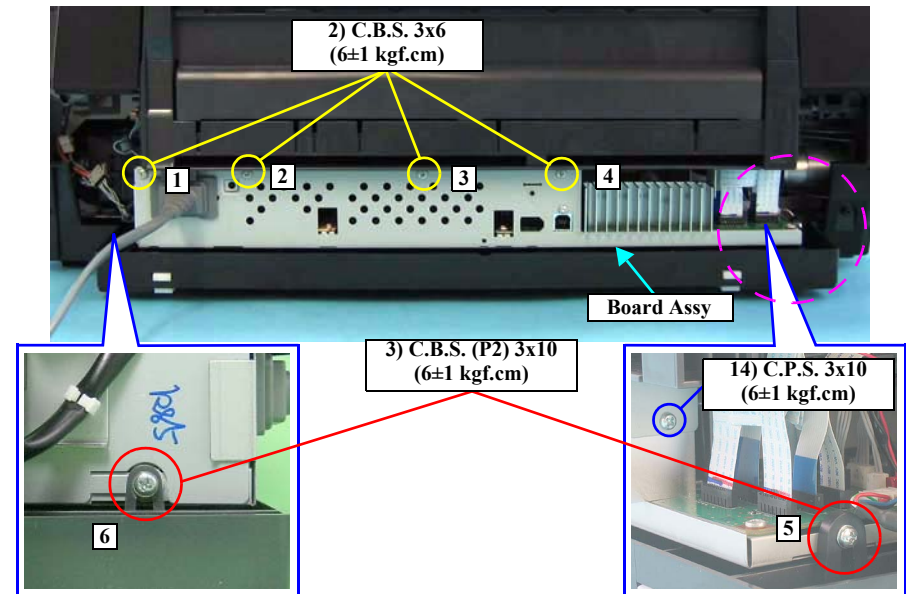

Figure 4-37. Screws that Secure the Board Assy



Tighten the screws in the order shown in Figure 4-37.



- See the page given below to check for sharp metal edges before starting maintenance/repair.
 - “Sharp Metal Edges” on page 75.
- When performing the following procedure, prevent the FFC and Connector Cables from being scratched.

3. Disconnect all the FFCs and Connector Cables connected to the Board Assy in order from the front, then draw out the Board Assy from the Printer taking care of the interference between the Manual Paper Guide and the Radiation Plates on the Board Assy.

- CN2: USB Host (PictBridge) (not equipped for Stylus Photo 1390)
- CN3: Relay Board FFC
- CN5: Operation Panel FFC
- CN6: Relay Connector Cable (for CR Motor)
- CN7: PF Motor Connector Cable
- CN8: Relay Connector Cable (for Pump Motor)
- CN9: APG Motor Connector Cable
- CN10: Head FFC
- CN11: Head FFC
- CN12: Head FFC
- CN13: Relay Connector Cable (for ASF Motor)
- CN14: CR Encoder Sensor/PW Sensor FFC
- CN15: CSIC FFC

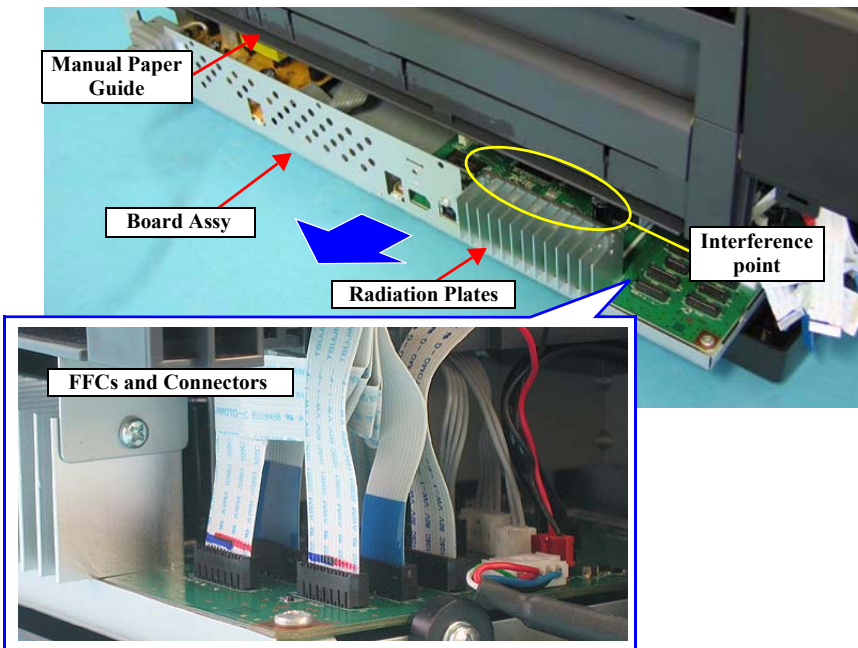

Figure 4-38. Removing the Board Assy



- Make sure that the FFCs are not crossing each other, and connect the FFCs and Connector Cables to the Main Board while paying attention to the edges of the Shield Plate.
- Take care not to put the Board Assy onto the three Ground Plates.

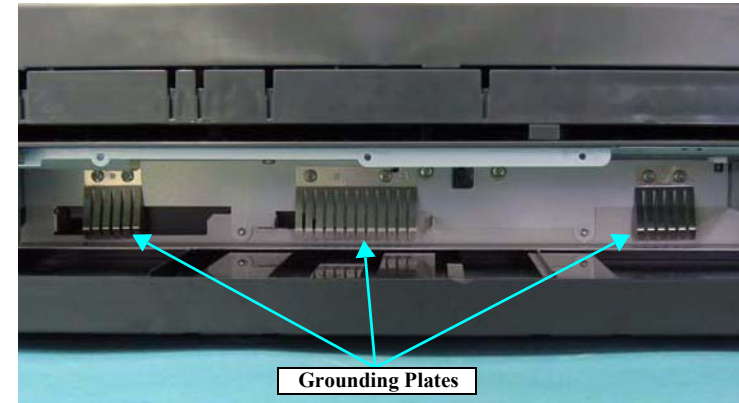

Figure 4-39. Installing the Board Assy (1)

- When installing the FFC to the connector (CN15), secure it with acetate tape as shown below.

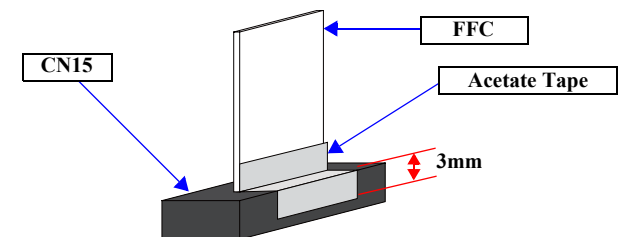

Figure 4-40. Installing the Board Assy (2)



- The following adjustment must be performed after replacing the Main Board.
 - When possible to read data from the old board
 1. Main Board Data Read/Write (p.132)
 - When impossible to read data from the old board
 1. Market & Initial Settings (p.132)
 2. USB ID Input (p.132)
 3. Head ID Input (p.132)
 4. Head Angular Adjustment (p.132)
 5. Bi-D Adjustment (p.132)
 6. First dot position (p.133)
 7. PW Sensor Adjustment (p.133)
 8. Reset PF Deterioration counter (write the maximum value) (p.133)
 9. PF Adjustment (p.133)
 10. PF Adjustment (Bottom Margin) (p.133)
 11. CR Motor Drive Dispersion (p.133)

Refer to Chapter 5 “Adjustment” for details on the adjustments.
- After replacing the Power Supply Board, the following adjustment must be performed.
 - CR Motor Drive Dispersion (p.133)

Refer to Chapter 5 “Adjustment” for details on the adjustments.

4.2.6 Disassembling the Printer Mechanism

4.2.6.1 CR Scale

1. Remove the Upper Housing.
 - For Stylus Photo 1400/1410: See section 4.2.1.4 on page 80.
 - For Stylus Photo 1390: See section 4.3.1 on page 128.
2. Release the Carriage lock, and move the Carriage Unit to the center.
 - See section 4.2.1.3 on page 79.



When performing the following procedure, take care not to damage or break the ends of the CR Scale.

3. Pull the right end of the CR Scale in the direction of the arrow, and remove the CR Scale from the tab on the Right CR Shaft Mounting Plate.
4. Draw out the right end of the CR Scale toward the left direction from the rear of the Carriage Unit.



Figure 4-41. Drawing Out the CR Scale

5. Release the coil section of Torsion Spring 24.7 from the tab on the Left CR Shaft Mounting Plate with tweezers.

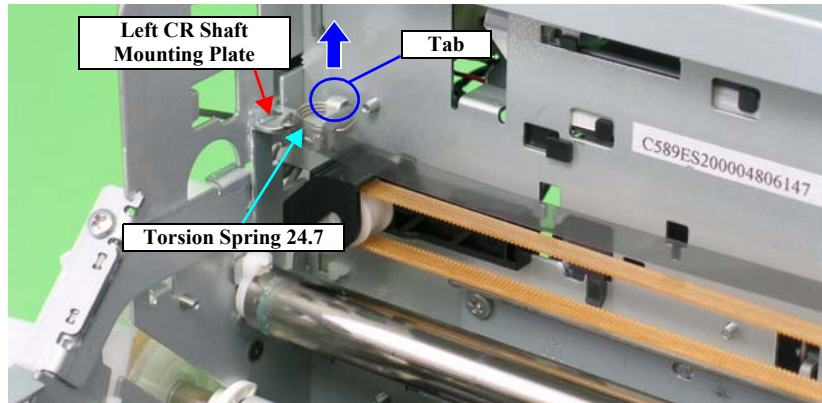

Figure 4-42. Removing the Torsion Spring 24.7 (1)

7. Turn the CR Scale 90°, and remove it from the tab on the Left CR Shaft Mounting Plate.

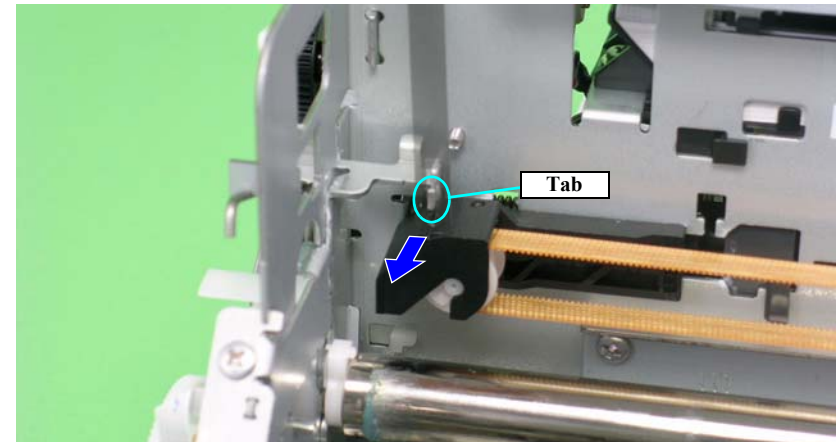

Figure 4-44. Removing the CR Scale

6. Remove Torsion Spring 24.7 from the CR Scale following the next steps:
 - 6-1. Bring the coil section to an upright position.
 - 6-2. Push downwards to release foot 1 from the cutout on the Left CR Shaft Mounting Plate.
 - 6-3. Turn the coil section counterclockwise.
 - 6-4. Remove Torsion Spring 24.7 from the hole on the CR Scale.

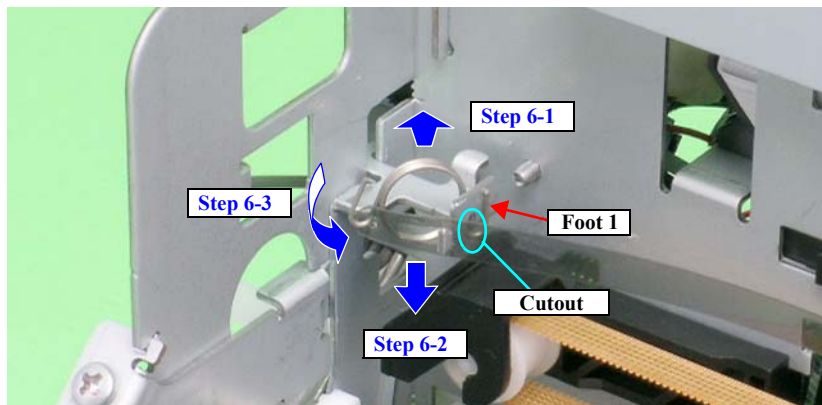

Figure 4-43. Removing the Torsion Spring 24.7 (2)



- Pass the CR Scale through the slit of the CR Encoder.

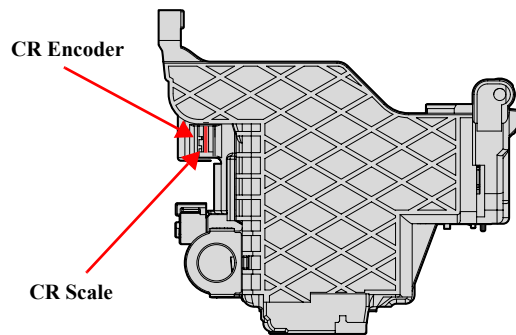

Figure 4-45. Installing the CR Scale (1)

- Set the CR Scale so that the chipped edge come to the top left corner.

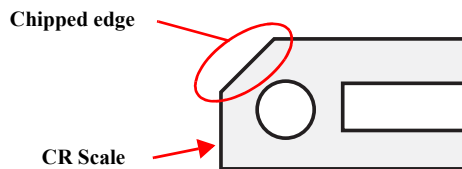

Figure 4-46. Installing the CR Scale (2)

- Place the right end of the CR Scale correctly so that it is not hooked onto the hooked portion of the Right CR Shaft Mounting Plate.

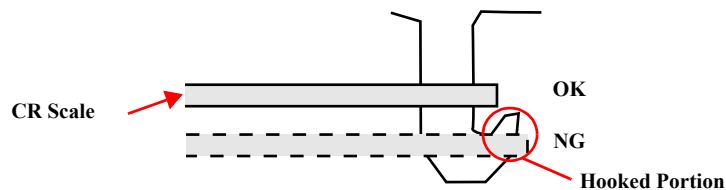

Figure 4-47. Installing the CR Scale (3)

4.2.6.2 CSIC Assy



- When removing the Head FFC Guide, do not use tools with sharp ends as the FFC may get damaged.
- Be careful not to break the Tabs of the FFC Guide.

1. Remove the CR Scale. See Section 4.2.6.1 on page 92.
2. Open the Cartridge Cover and remove all Ink Cartridges.
3. Disengage the two tabs of the Head FFC Cover, and while disengaging the dowel with a flathead screw driver, slide it upward, and rotate it around the Hinge by 90°.

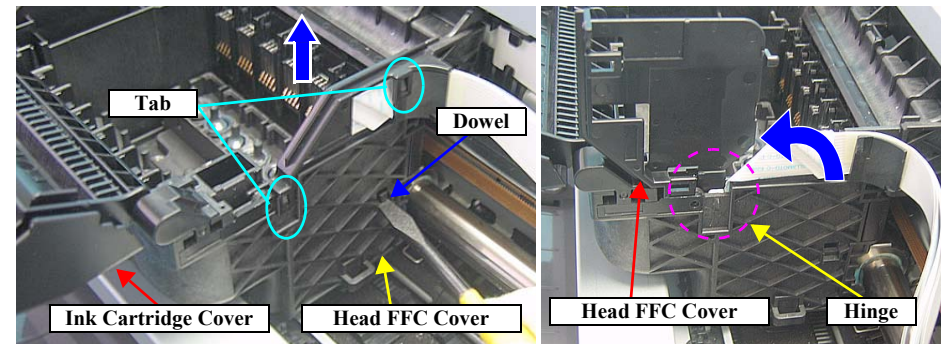

Figure 4-48. Removing the Head FFC Cover

4. Using the special tool (refer to p75), disengage tab A of the CSIC Assy on the right rear side of the Carriage Unit.

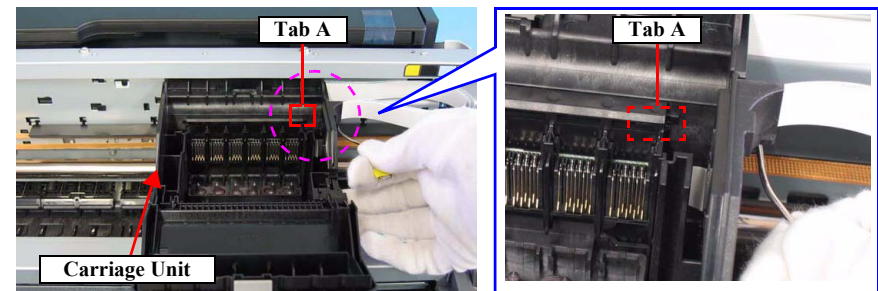

Figure 4-49. Removing the CSIC Assy (1)

- Using the special tool (refer to p75), disengage tab B of the CSIC Assy on the right rear side of the Carriage Unit.

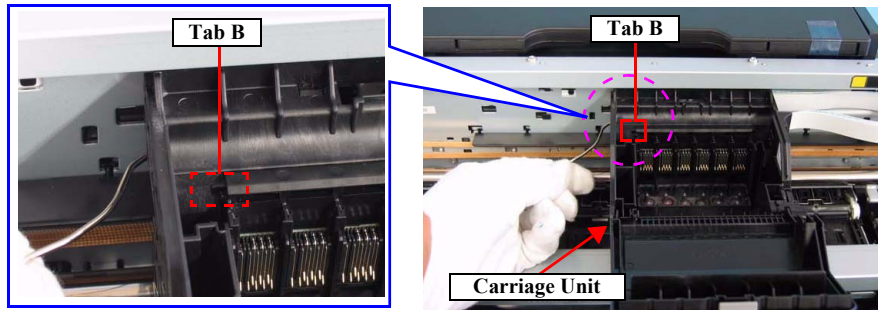

Figure 4-50. Removing the CSIC Assy (2)

- Lift up the CSIC Assy from the Carriage Unit to disconnect the CSIC FFC, and remove the CSIC Assy.

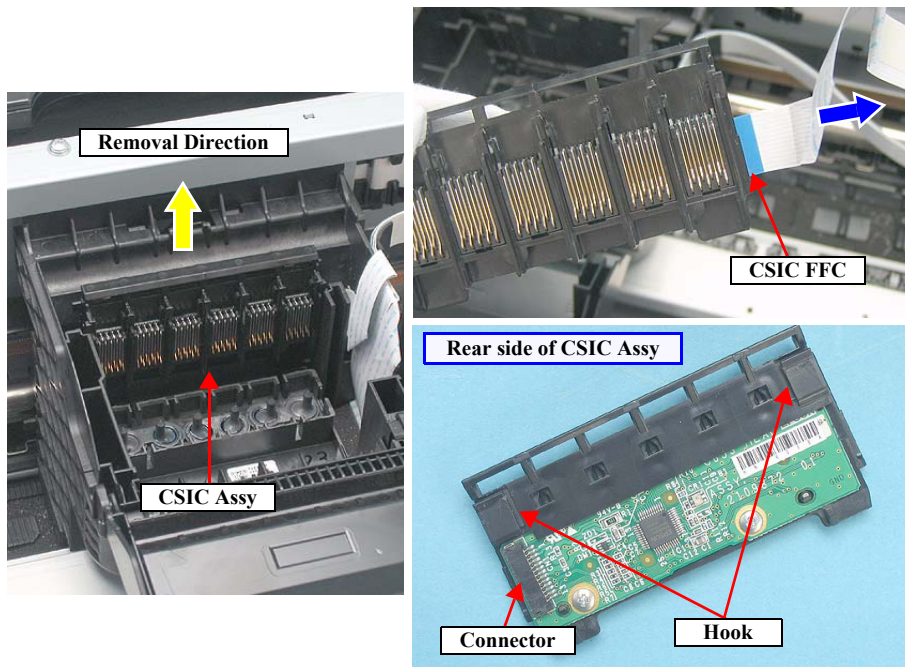

Figure 4-51. Removing the CSIC Assy (3)

4.2.6.3 Printhead

- Remove the CSIC Assy. See Section 4.2.6.2 on page 94.
- Remove the three C.B.P. 2.6x8 screws that secure the Printhead using Phillips Screw Driver, No.1, and remove the Printhead by lifting it up vertically.

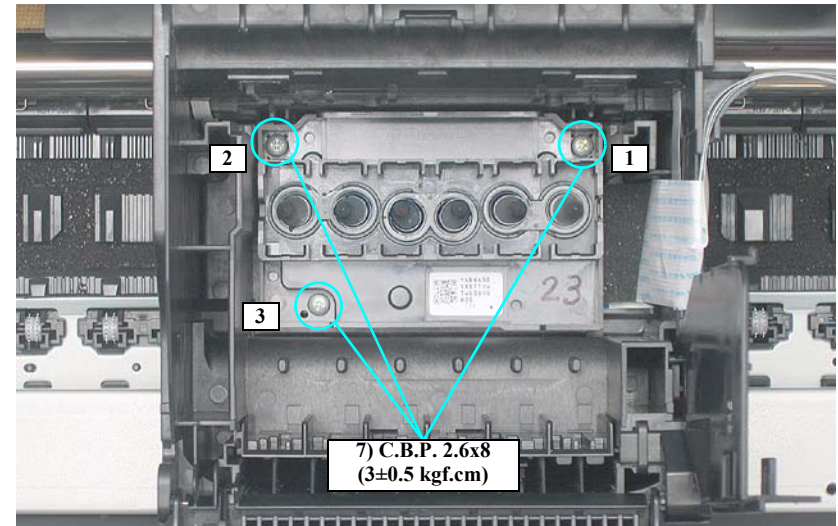

Figure 4-52. Removing the Printhead (1)

- Disconnect the two Head FFCs on the back side, and remove the Printhead.

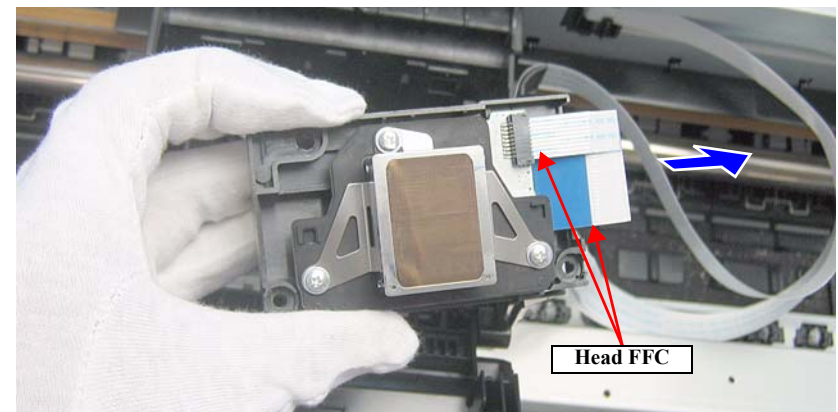

Figure 4-53. Removing the Printhead (2)



Tighten the screws in the order shown in [Figure 4-52](#).



After replacing or removing the Printhead, the following adjustment must be performed.

1. PG Adjustment ([p.132](#))
2. Head ID Input (only after replacing) ([p.132](#))
3. Head Angular Adjustment ([p.132](#))
4. Bi-D Adjustment ([p.132](#))
5. First dot position ([p.133](#))
6. PW Sensor Adjustment ([p.133](#))

Refer to Chapter 5 “Adjustment” for details on the adjustments.

4.2.6.4 APG Assy

1. Remove the Upper Housing.
For Stylus Photo 1400/1410: [See section 4.2.1.4 on page 80.](#)
For Stylus Photo 1390: [See section 4.3.1 on page 128.](#)
2. Disconnect the APF Motor Cable from connector CN9 (red) on the Main Board
3. Remove the acetate tape, and remove the Cable from the ASF Assy.
4. Disconnect the Connector Cables from the two APG Sensor Connectors.

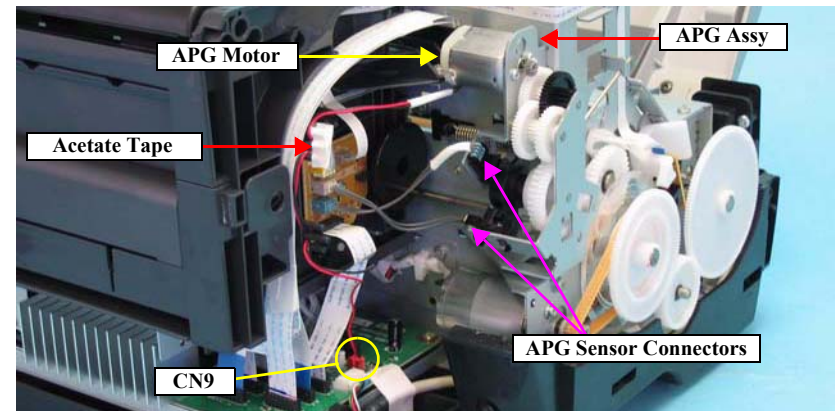

Figure 4-54. Disconnecting the Connector Cables

5. Remove the three C.B.S. 3x6 screws that secure the APG Assy and remove the APG Assy from the Main Frame.

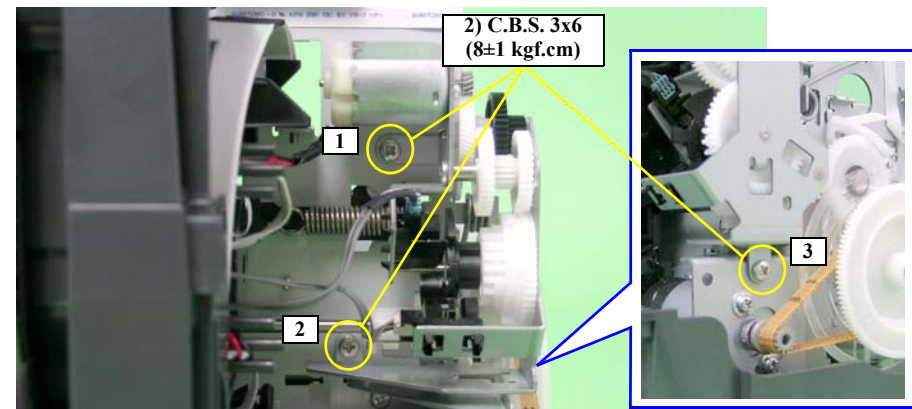
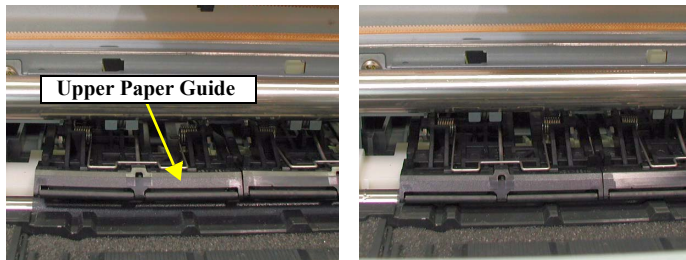

Figure 4-55. Removing the APG Assy



- When installing the APG Assy, make sure that the FLAG Release Assy is NOT in a released state (with the Upper Paper Guide down).



Released Not Released
 Figure 4-56. Installing the APG Assy

- Refer to [Figure 4-54](#), and route the APG Connector Cables correctly.



- Match the phase of the APG Assy following the next steps.
 1. Match the delta marks of Spur Gear 16 and Combination Gear 22, 28.8, 32.4.

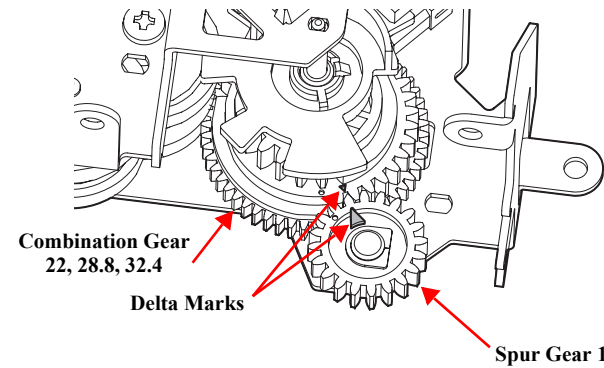

2. At the position where the tab can be identified through the cutout of the PG Frame, match the delta marks of Spur Gear 16 and PG Cam (Left).

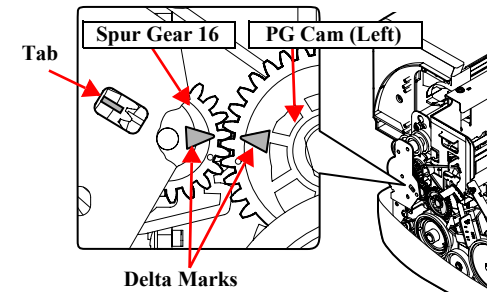

Figure 4-57. Phase Matching

- Tighten the screws in the order shown in [Figure 4-55](#).

4.2.6.5 Carriage Shaft and Carriage Unit

1. Remove the APG Assy. See Section 4.2.6.4 on page 96.
2. Turn the PG Cam (Right) around so that any mark other than PG++ comes to the bottom.

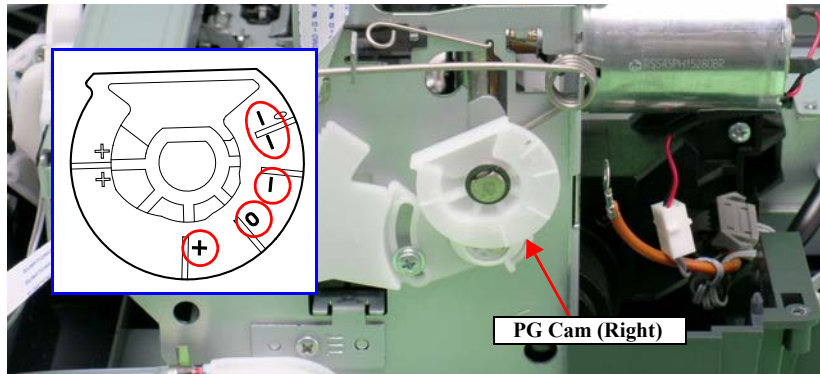

Figure 4-58. Setting the PG Cam

3. Remove the two C.B.S. 3x6 screws that secure the Frame Support Plate (Left), and remove it.

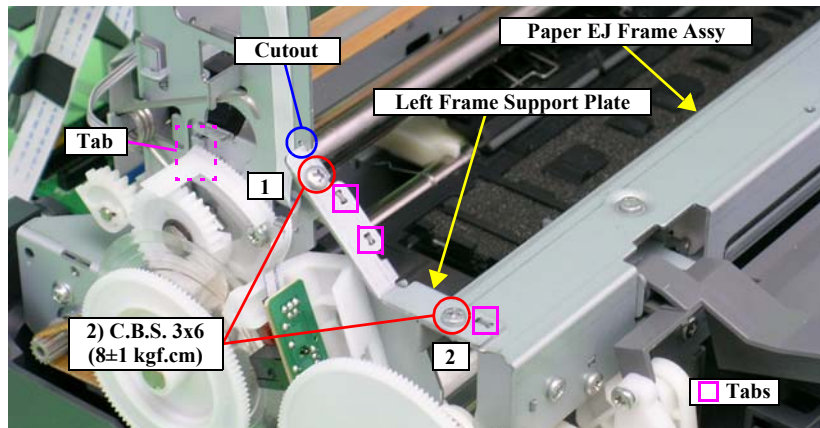

Figure 4-59. Removing the Left Frame Support Plate



- Insert the Left Frame Support Plate into the cutout of the Main Frame. See Figure 4-59.
- Align the two tabs on the Main Frame and the tab on the Paper EJ Frame Assy with the three positioning holes on the Left Frame Support Plate. See Figure 4-59.
- Align the tab (rear side) of the Left Frame Support Plate with the outside of the Left CR Shaft Mounting Plate. See Figure 4-59.
- Tighten the screws in the order shown in Figure 4-59.

4. Remove the foot of Left PG Torsion Spring from Tab A, and release the coil section from Tab B to remove Left PG Torsion Spring from the Main Frame.

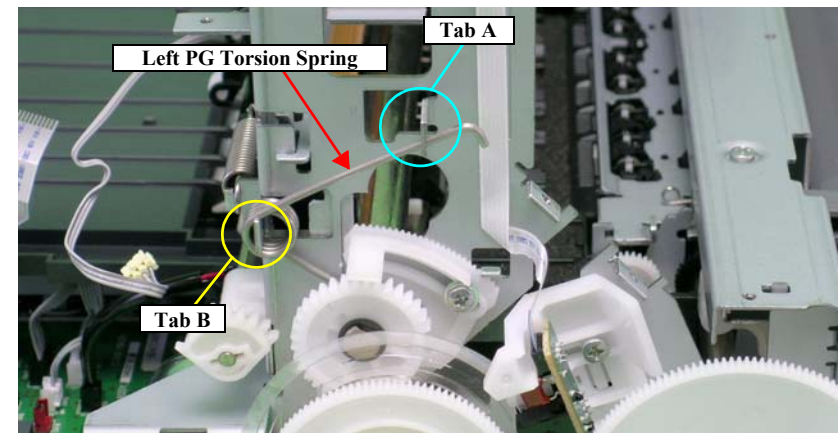

Figure 4-60. Removing the Left PG Torsion Spring

- Remove the foot of Right PG Torsion Spring from Tab A, and release the coil section from Tab B to remove the Right PG Torsion Spring from the Main Frame.

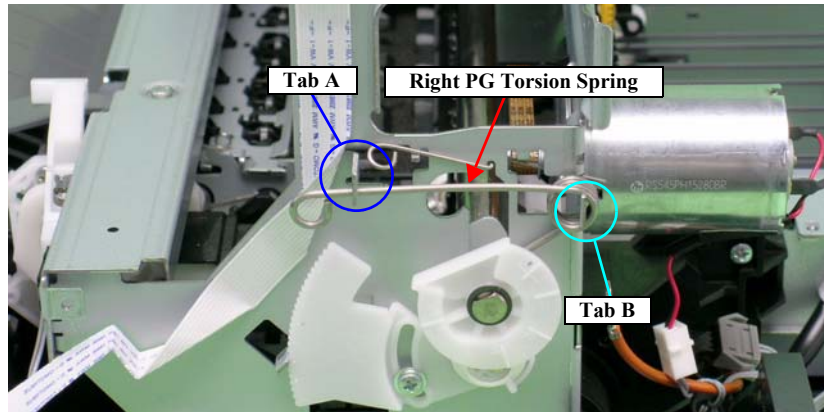

Figure 4-61. Removing the Right PG Torsion Spring

- Remove CR Shaft Mounting Plate Fixed Spring from the tab and cutout on the Main Frame, and draw out the spring in the direction of the arrow.

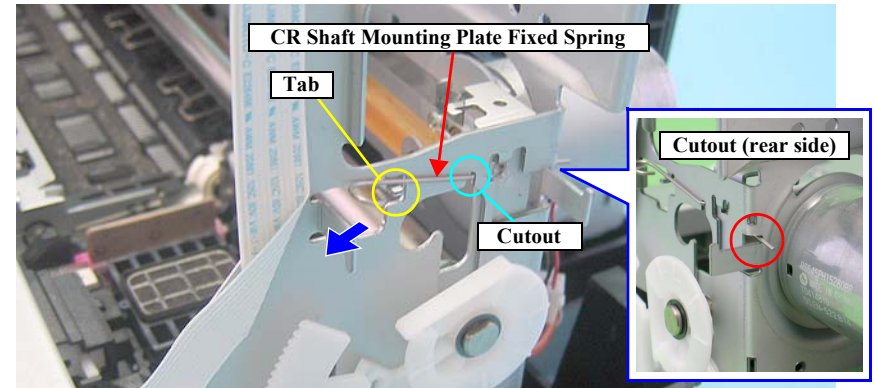

Figure 4-63. Removing the CR Shaft Mounting Plate Fixed Spring



Place the feet of Left PG Torsion Spring and Right PG Torsion Spring on the Carriage Shaft.

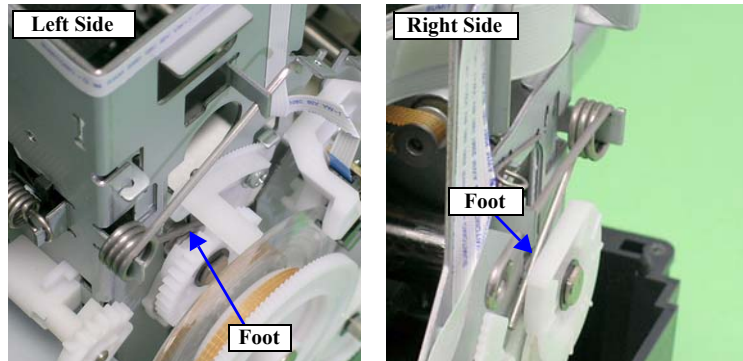

Figure 4-62. Installing the PG Torsion Springs



Insert the foot of CR Shaft Mounting Plate Fixed Spring into the cutout of the Main Frame (rear side). See Figure 4-63.

- Remove the Extension Spring for the Driven Pulley Holder from the Main Frame and the tab on the Drive Pulley Holder with needle-nose pliers.

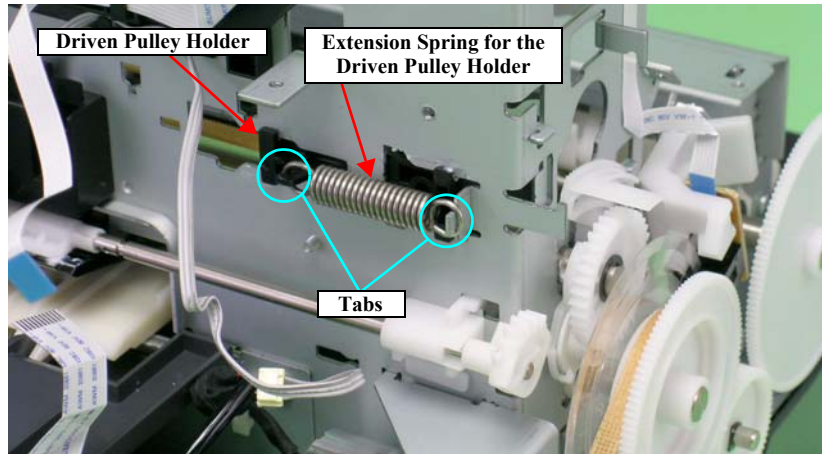

Figure 4-64. Removing the Extension Spring for the Driven Pulley Holder

- Slide the Driven Pulley Holder to the right end of the cutout on the Main Frame, then remove it toward you.

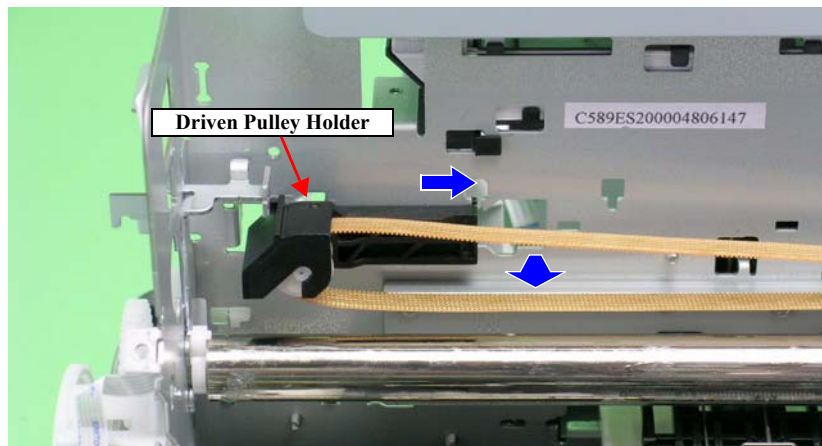

Figure 4-65. Removing the Driven Pulley Holder

- Remove the CR Drive Belt from the CR Motor Pinion Gear.

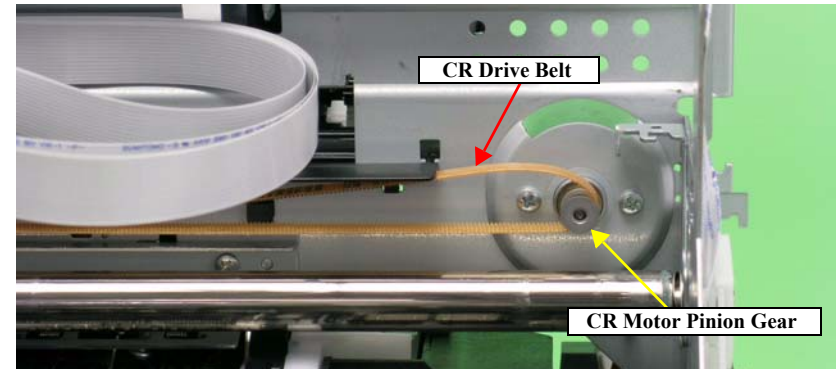

Figure 4-66. Removing the CR Drive Belt

- Remove the four C.B.S. (P4) 3x6 screws that secure the CR Guide plate, and remove it from the Main Frame.

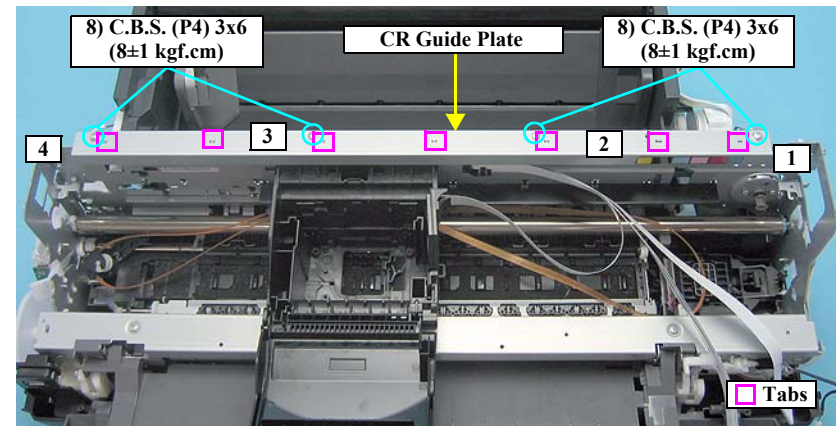

Figure 4-67. Removing the CR Guide Plate



- Align the positioning holes of the CR Guide Plate with the seven tabs on the Main Frame. See Figure 4-67.
- Tighten the screws in the order shown in Figure 4-67.

- Loosen the C.B.S. (P4) 3x8 screw that secures the Left Parallelism Adjust Bushing, and rotate the Bushing toward the front of the Printer Mechanism to prevent interference between the Flag of the Parallelism Adjust Bushing and the Left PG Cam.

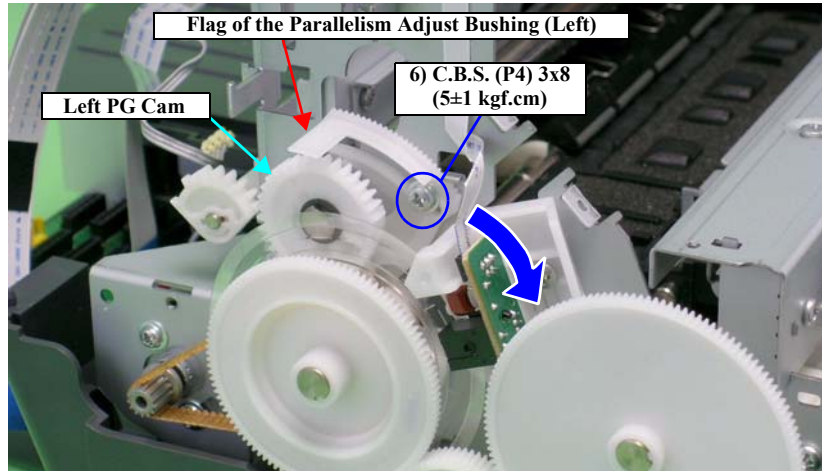

Figure 4-68. Rotating the Left Parallelism Adjust Bushing

- Slide the Left CR Shaft Mounting Plate upwards, and release the tab on the Left CR Shaft mounting Plate from the cutout of the Main Frame to rotate the Mounting Plate toward you.

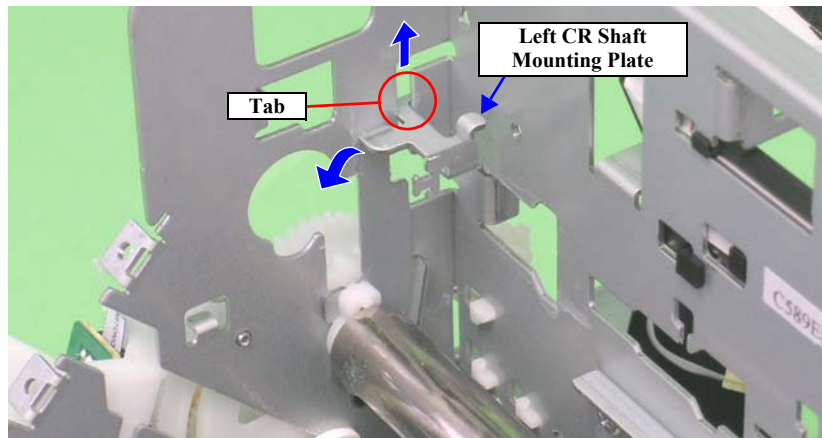

Figure 4-69. Rotating the Left CR Shaft Mounting Plate

- Lift the Carriage Shaft upwards, and remove the Carriage Shaft Spacer from the Carriage Shaft with tweezers.

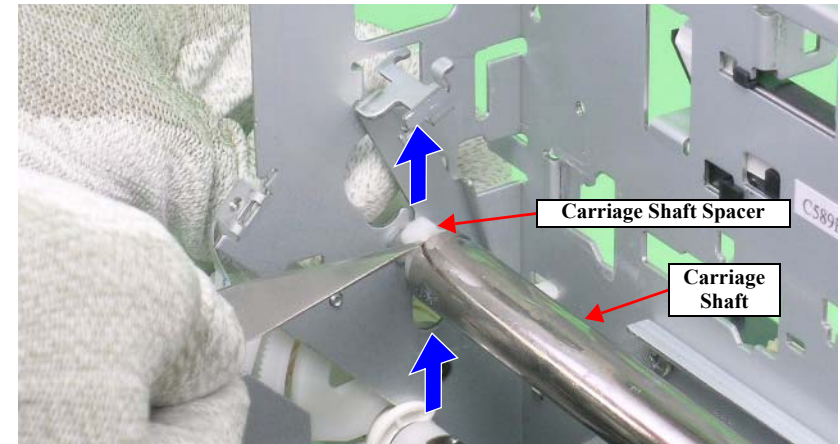

Figure 4-70. Removing the Carriage Shaft Spacer

- Rotate the Left CR Shaft Mounting Plate toward you to remove the Bushing on the Left CR Shaft Mounting Plate from the Carriage Shaft.

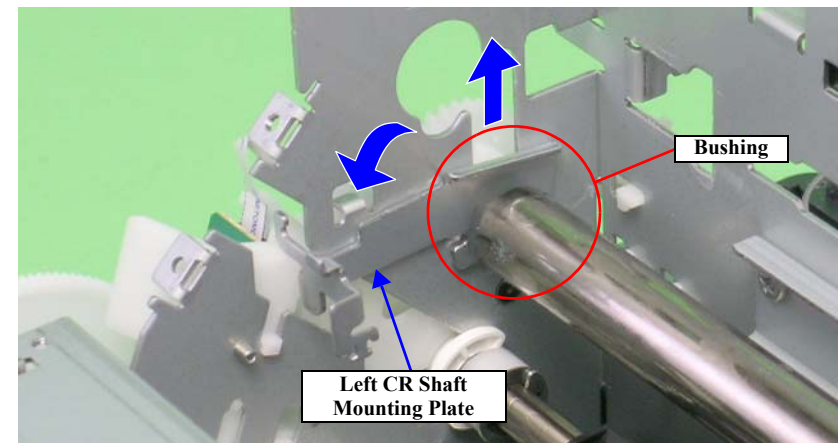

Figure 4-71. Removing the Left CR Shaft Mounting Plate

- Lift the Carriage Shaft to the hole of the Main Frame and remove the Spacer and Left PG Cam from the Carriage Shaft.

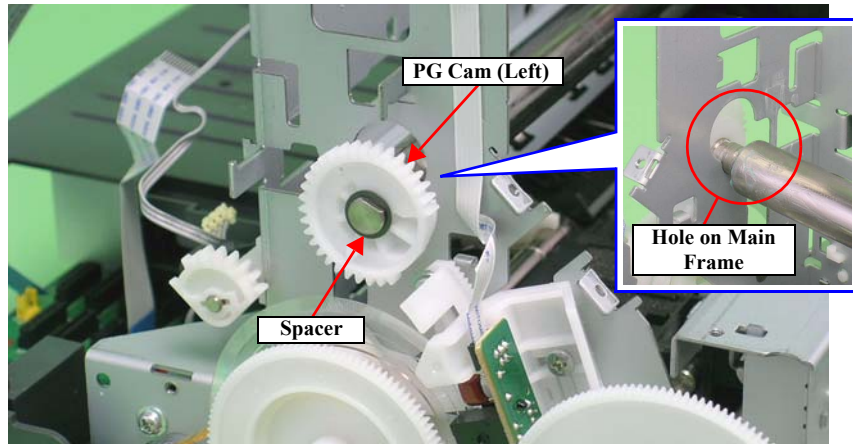

Figure 4-72. Removing the Left PG Cam

- Remove the Spacer and Right PG Cam from the Carriage Shaft.

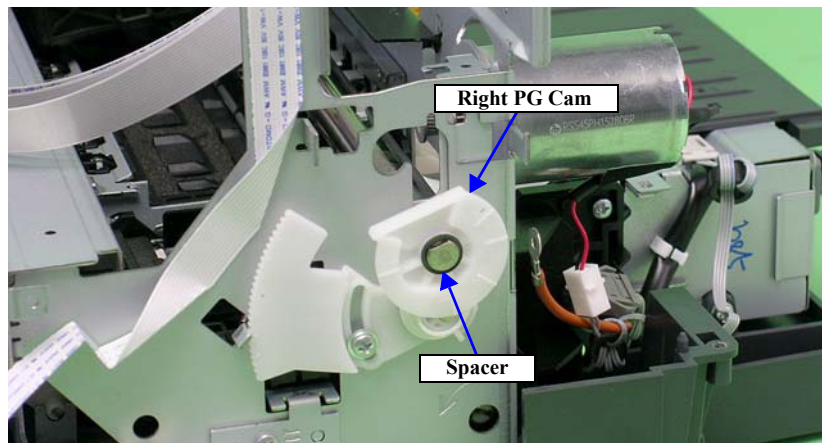

Figure 4-73. Removing the Right PG Cam



When installing the Right PG Cam, make sure that one of these positions marked “0”, “+” or “++” comes to the bottom.

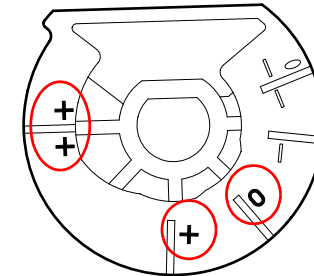

Figure 4-74. Right PG Cam Installation Direction

- Pull the Right CR Shaft Mounting Plate away from the tab on the Main Frame and rotate toward you.

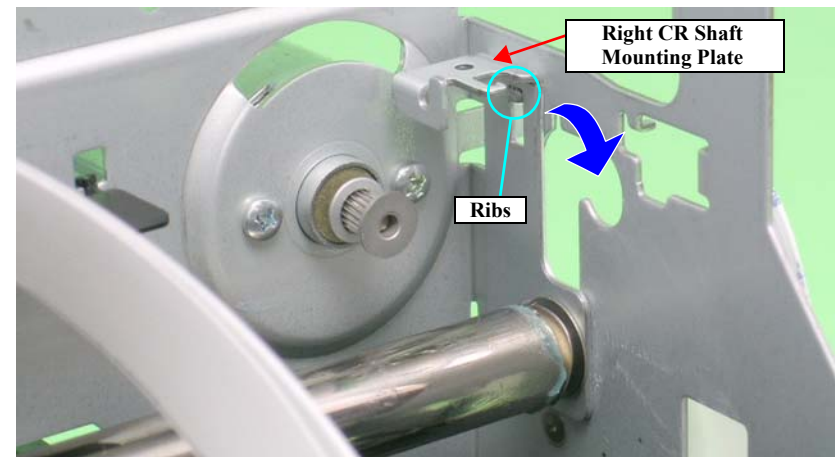

Figure 4-75. Rotating the Right CR Shaft Mounting Plate



When performing the following procedure, take care not to scratch the Carriage Shaft.

18. To prevent the CR Scale Cover from interfering with the back of the Carriage Unit, slide the Carriage unit to the left side, shift the Carriage Shaft to the left direction to remove the Carriage Shaft from both the Main Frame and the Carriage Unit, release the right end from the Main Frame, and draw out the Carriage shaft.

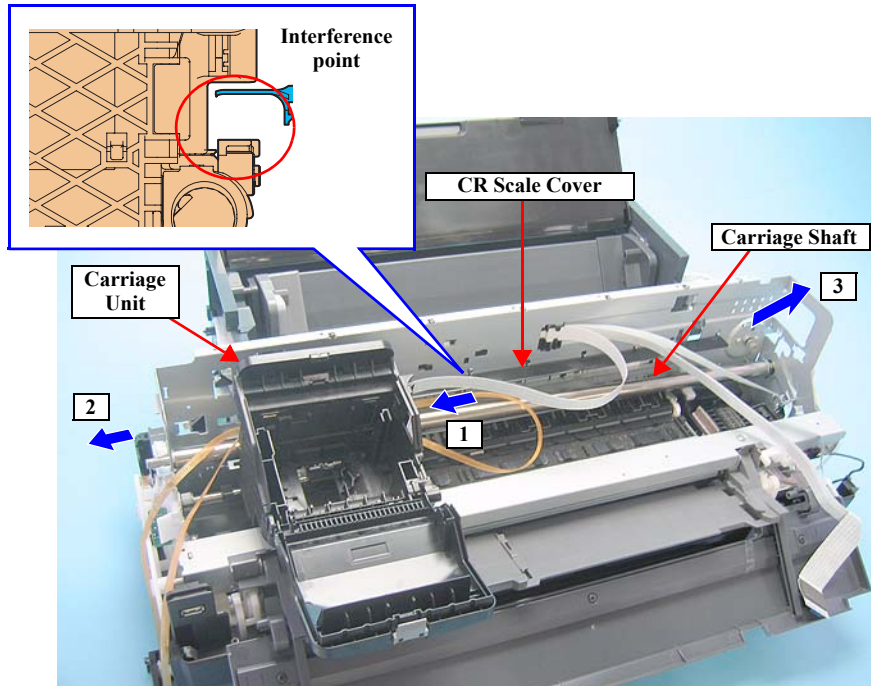

Figure 4-76. Removing the Carriage Shaft



- Set the longer end of the Carriage Shaft to the left side.
- When the Carriage Shaft is removed, the Plain Spring and Leaf Spring that are attached to the right end of the Carriage Shaft may drop off. In such case, be sure to attach them in the order as shown in the figure below

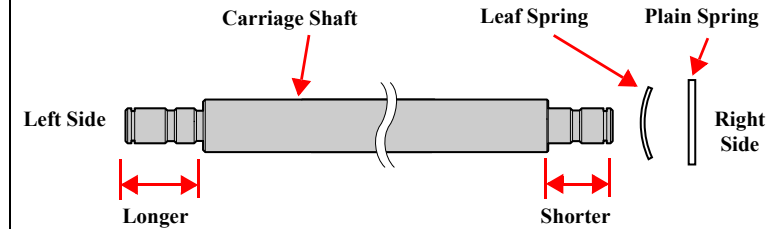

Figure 4-77. Installing the Carriage Shaft

19. Remove the CR Drive Belt from the Carriage Unit.

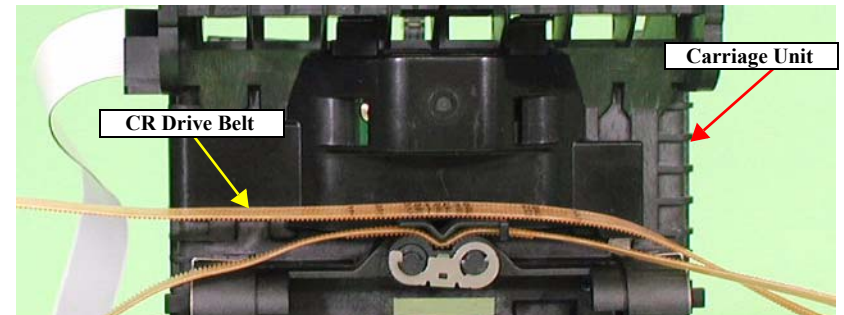

Figure 4-78. Removing the CR Drive Belt



Refer to the figure below and install the CR Drive Belt so that its top and rear sides face the correct way.

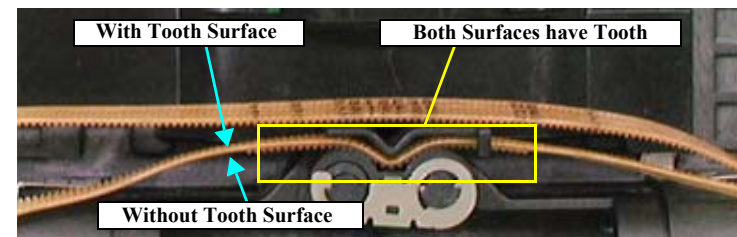

Figure 4-79. Installing the CR Drive Belt

20. Turn the Belt Holder Mounting Plate in the direction of the arrow, and remove it from the Carriage Unit.

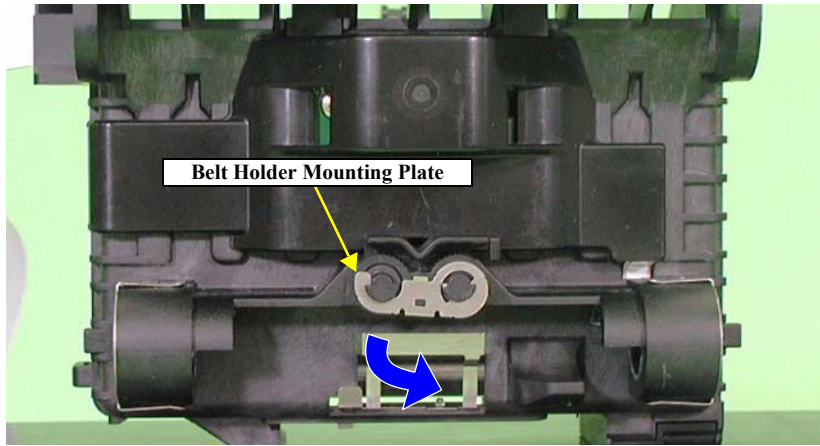

Figure 4-80. Removing the Belt Holder (1)

21. Remove the Belt Holder from the Carriage unit.

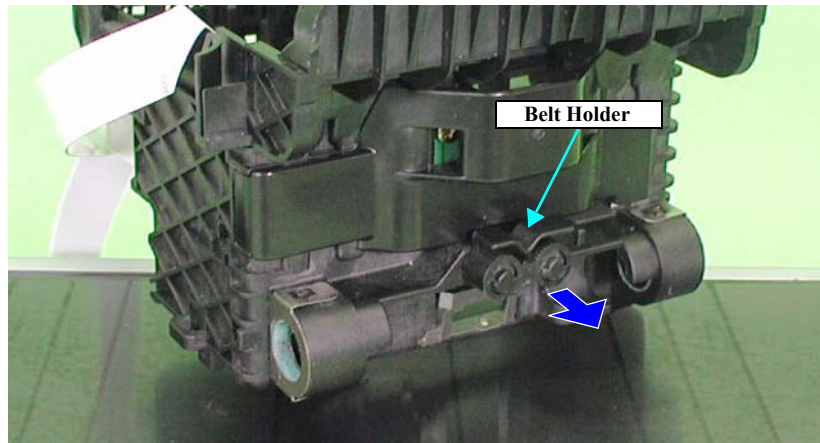

Figure 4-81. Removing the Belt Holder (2)

22. Release the CR Encoder Board Holder from the three tabs to remove it from the Carriage Unit.

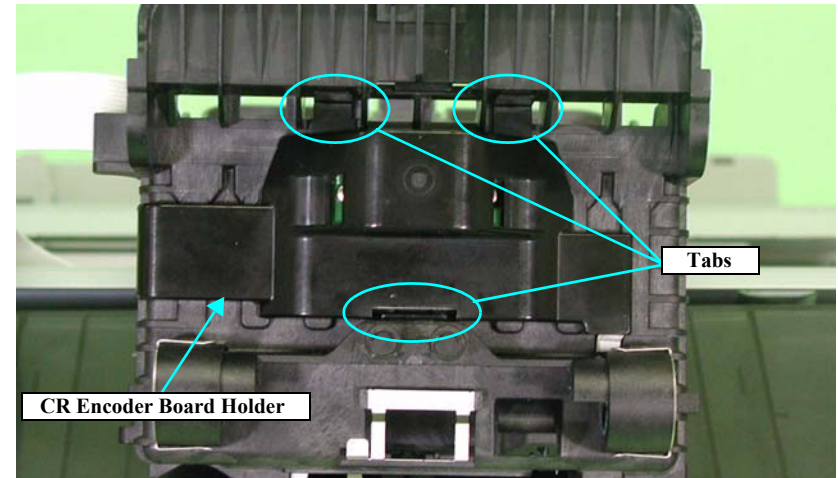

Figure 4-82. Removing the CR Encoder Board Holder

23. Disconnect the Sensor FFC from the CR Encoder Board, pull out the Sensor FFC from the Carriage Unit, and remove the Carriage Unit.

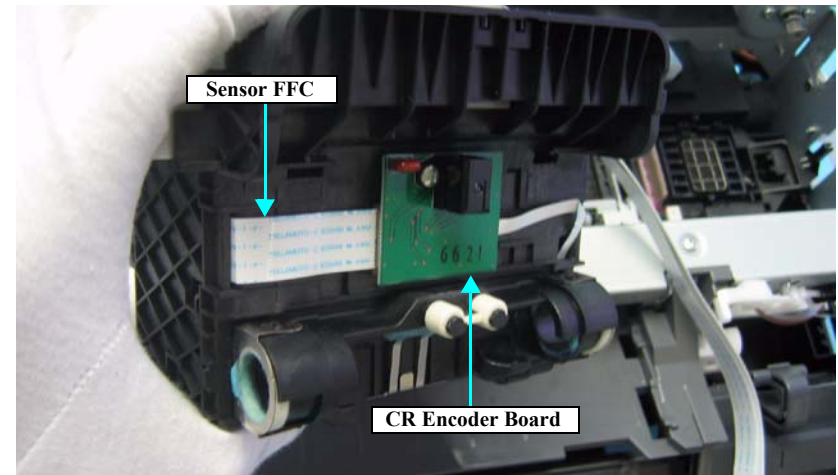

Figure 4-83. Removing the Carriage Unit



- After replacing the parts listed below, be sure to apply G-26 or G-71 grease to the area specified for each part.
 - Left and Right Parallelism Adjust Bushing (p.151)
 - Left and Right CR Scale Mounting Plate (p.151)
 - Left and Right PG Cam (p.152)
 - Left and Right PG Torsion Spring (p.152)
 - CR Guide Plate (p.152)
 - Driven Pulley Holder (p.153)
 - Carriage Shaft (p.152) and “Lubrication of Carriage Shaft” on page 154.
- After replacing or removing the Carriage Shaft and Carriage Unit, the following adjustment must be performed.
 1. PG Adjustment (p.132)
 2. Head Angular Adjustment (p.132)
 3. Bi-D Adjustment (p.132)
 4. First dot position (p.133)
 5. PW Sensor Adjustment (p.133)

Refer to Chapter 5 “Adjustment” for details on the adjustments.

4.2.6.6 PictBridge Unit



Stylus Photo 1390 does not have the PictBridge Unit. Skip this section for the model.



See the page given below to check for sharp metal edges before starting maintenance/repair.

- “Sharp Metal Edges” on page 75.

1. Remove the Printer Mechanism. See section 4.2.1.5 on page 82.
2. Disconnect the PictBridge Unit Connector Cable from connector CN2 on the Main Board.
3. Remove the Acetate Tape and remove the PictBridge Unit from the Main Frame.

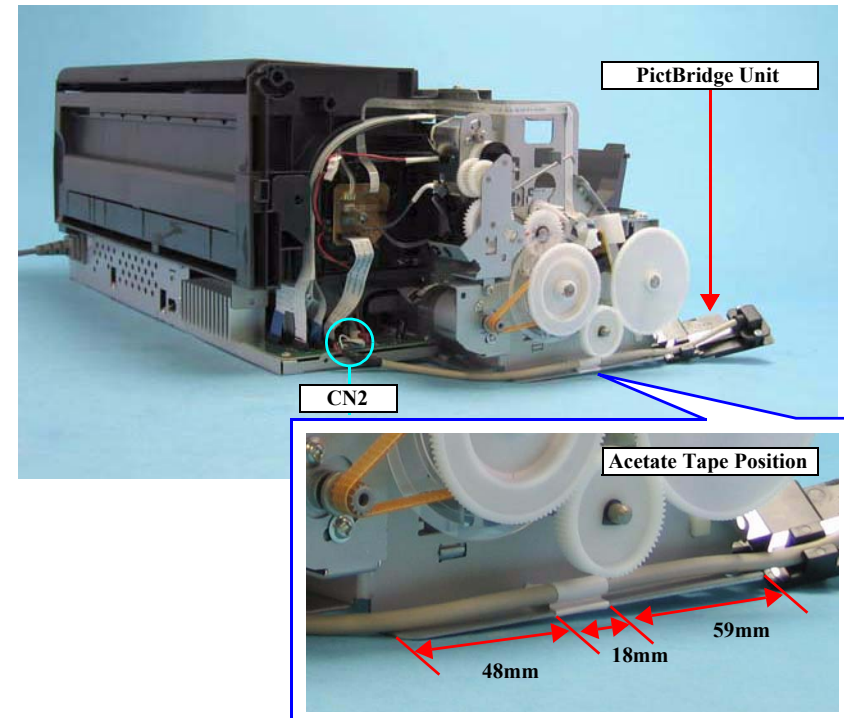

Figure 4-84. Removing the PictBridge Unit

4.2.6.7 Paper EJ Frame Assy



See "4.3.2 Paper EJ Frame Assy" on page 129 to remove the Paper EJ Frame Assy of Stylus Photo 1390.

1. Remove the Printer Mechanism. See section 4.2.1.5 on page 82.
2. Remove the CD-R Unit Housing from the CD/DVD Tray Base by releasing the Housing from two attaching points to the Tray Base.
3. Remove the Left Frame Support Plate. See Step 2 in Section 4.2.6.5 on page 98.
4. Put back the rotation position of the Right PG Cam.
5. Remove the four C.B.S. 3x6 screws and two C.B.P. 3x8 screws that secure the Paper EJ Frame Assy.



When performing the following procedure, take care not to scratch the Star Wheel.

6. Remove the two Guide Pins on the CD/DVD Tray Base from the Left and Right CD-R Release Lever Sub Assys.
7. Pull the Star Wheel Roller toward you, and remove the Paper EJ Frame Assy from the Printer Mechanism while keeping the Assy from coming in contact with the Right CD-R Release Lever Sub Assy and the tab on the Right CD-R Cover.

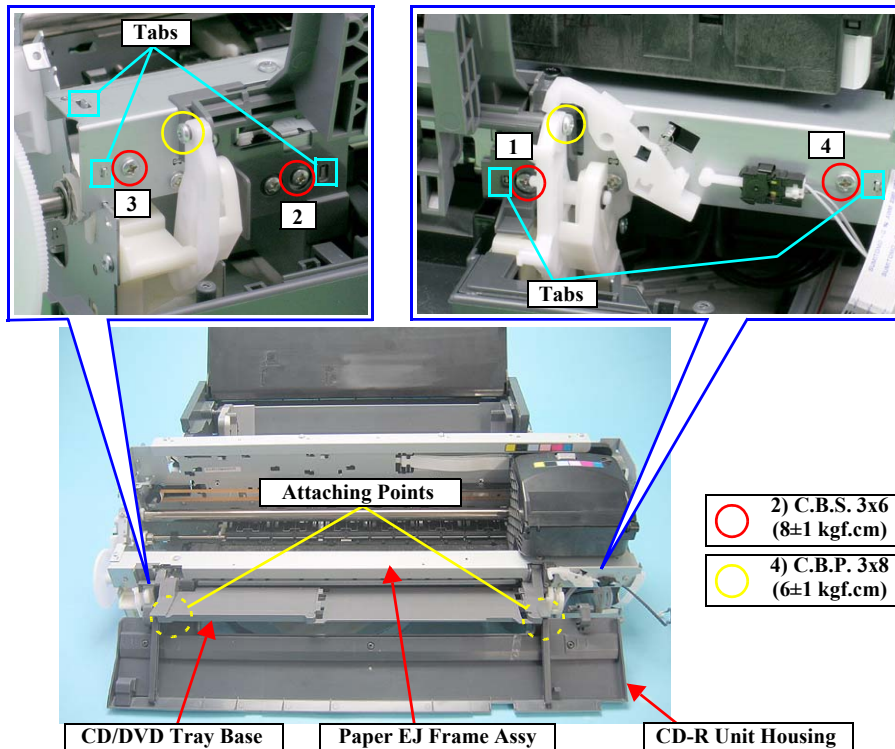

Figure 4-85. Screws that Secure the Paper EJ Frame Assy

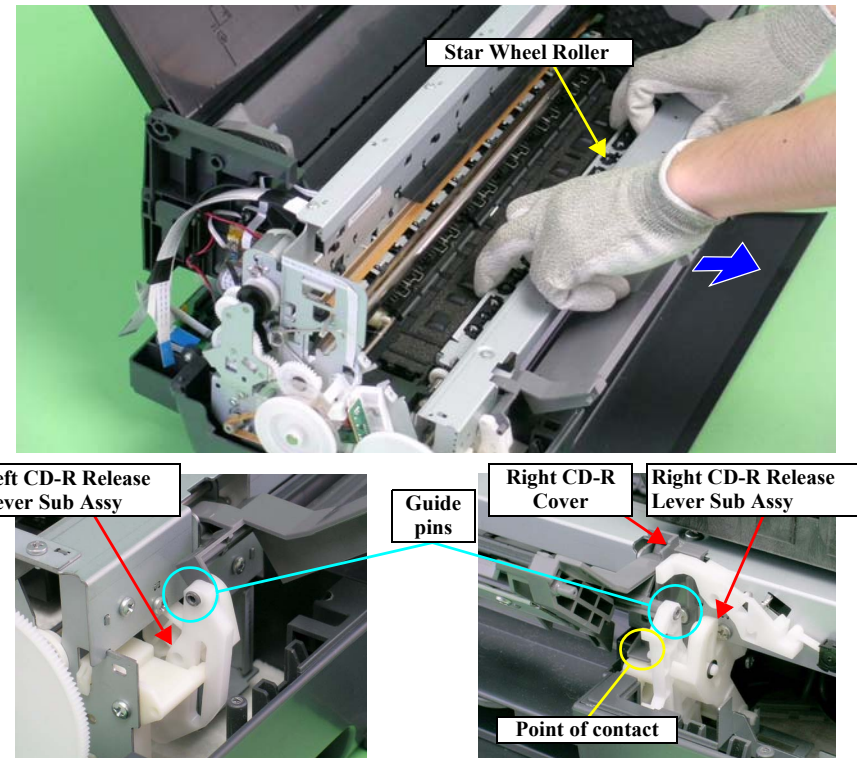

Figure 4-86. Removing the Paper EJ Frame Assy



- Hook both rear ends of the Paper EJ Frame Assy onto the tabs of the Main Frame.
- Align the Bearing of the CD-R Release Level Sub Assy with the Paper EJ Release Shaft.

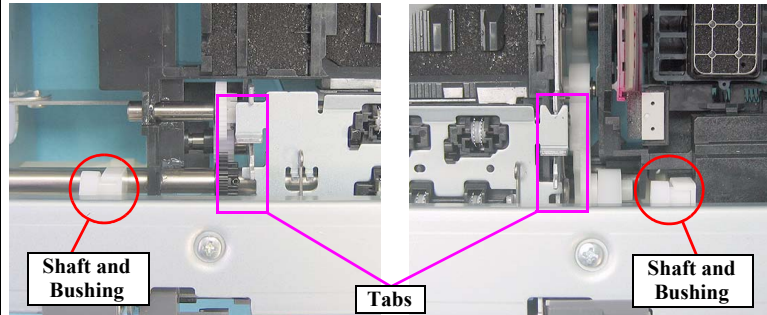

Figure 4-87. Installing the Paper EJ Frame Assy

- Match the tabs with the five Positioning Holes. See Figure 4-85.
- Tighten the screws in the order shown in Figure 4-86.



After replacing or removing the Paper EJ Frame Assy, the following adjustment must be performed.

1. PW Sensor Adjustment (p.133)
2. PF Adjustment (p.133)
3. PF Adjustment (Bottom Margin) (p.133)

Refer to Chapter 5 “Adjustment” for details on the adjustments.

4.2.6.8 CD-R Release Lever Sub Assy



The Stylus Photo 1390 does not have the CD-R Release Lever Sub Assy. Skip this section for the model.

1. Remove the Paper EJ Frame Assy. See section 4.2.6.7 on page 106.
2. Remove the Shaft on the Right CD-R Release Base from the Bushing on the CD-R Release Lever.

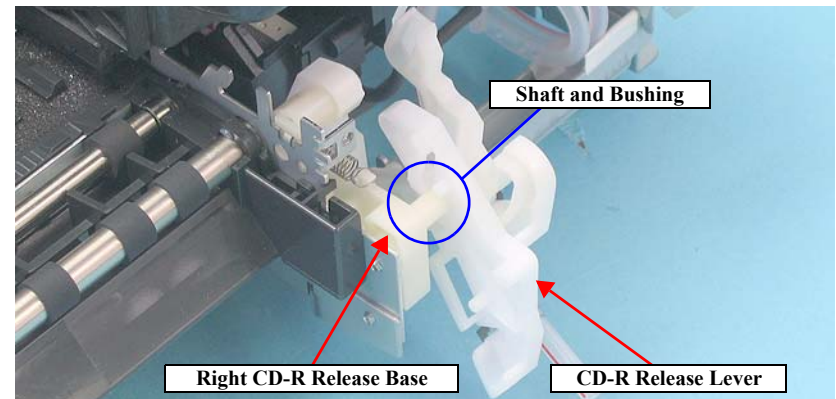

Figure 4-88. Removing the Right CD-R Release Lever Sub Assy (1)

- Remove the C.B.S. 3x6 screw that secures the Right CD-R Release Lever Sub Assy.

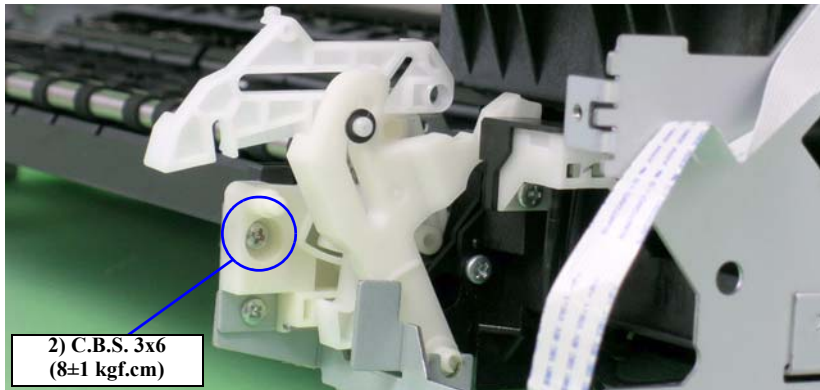

Figure 4-89. Removing the Right CD-R Release Lever Sub Assy (2)

- To prevent parts from dropping, refit the shaft on the Right CD-R Release Base into the CD-R Release Lever.
- Push the Guide Pin that secures the Right CD-R Release Lever Sub Assy with tweezers, and remove it upwards from the Main Frame.

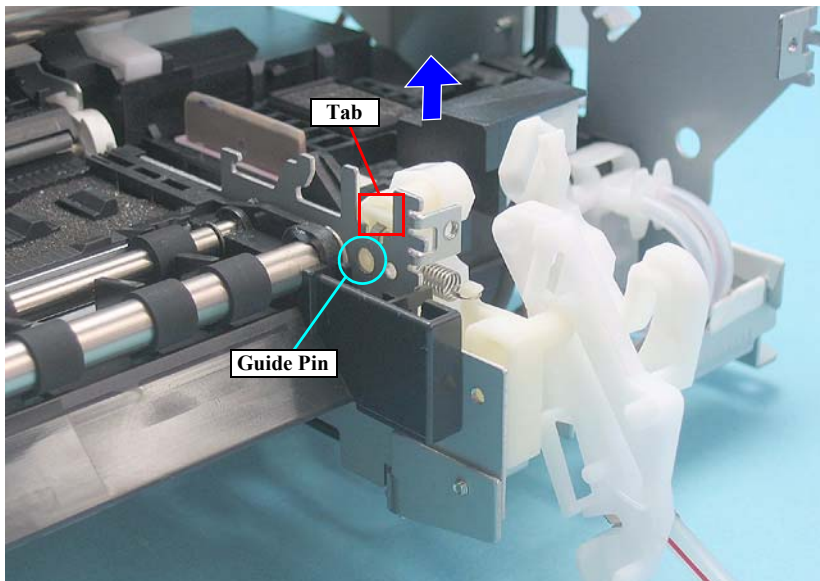

Figure 4-90. Removing the Right CD-R Release Lever Sub Assy (3)



- Make sure that the Right CD-R Release Lever Sub Assy is correctly assembled as shown in the figure below.

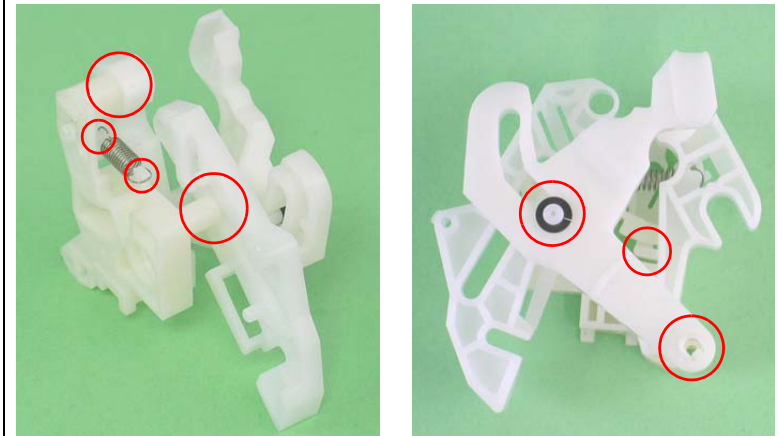

Figure 4-91. Reassembling the Right CD-R Release Lever Sub Assy

- Align the Shaft and Bushing.

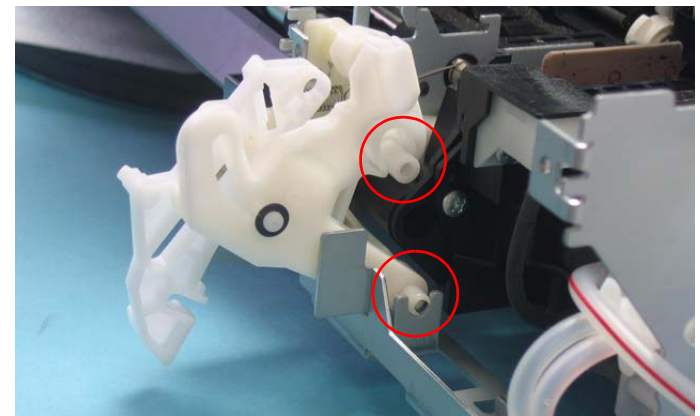

Figure 4-92. Reinstalling the Right CD-R Release Lever Sub Assy

- Align the positioning hole of the Right CD-R Release Lever Sub Assy with the tab on the Main Frame. See Figure 4-90.

6. Remove Spur Gear 68 from the Paper EJ Roller Shaft.

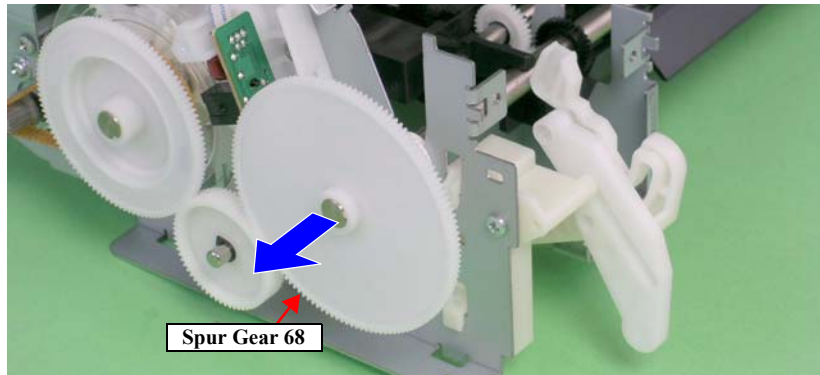

Figure 4-93. Removing the Spur Gear 68

7. Remove the C.B.P. 3x6 screw that secures the Left CD-R Release Lever Sub Assy.
8. Push the small tab of the Left CD-R Release Lever Sub Assy with a flat-blade screwdriver, and remove the Left CD-R Release Lever Sub Assy upwards from the Main Frame.

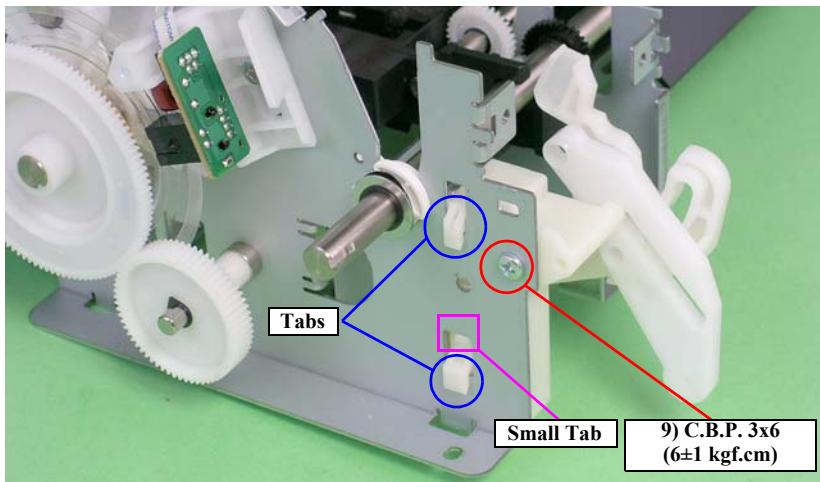

Figure 4-94. Removing the Left CD-R Release Lever Sub Assy



- Make sure that the Left CD-R Release Lever Sub Assy is correctly assembled as shown in the figure below.

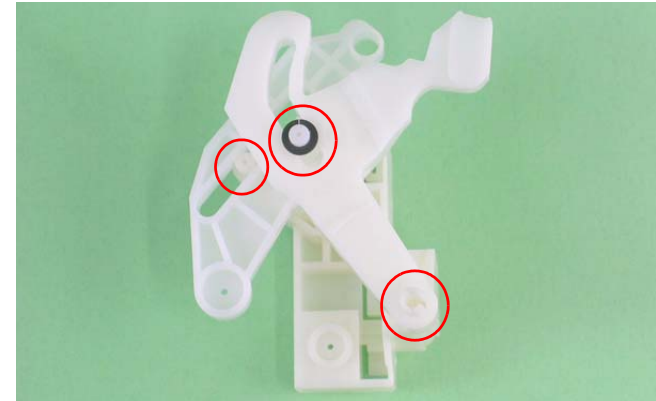

Figure 4-95. Reinstalling the Left CD-R Release Lever Sub Assy (1)

- Align the Shaft and Bushing.

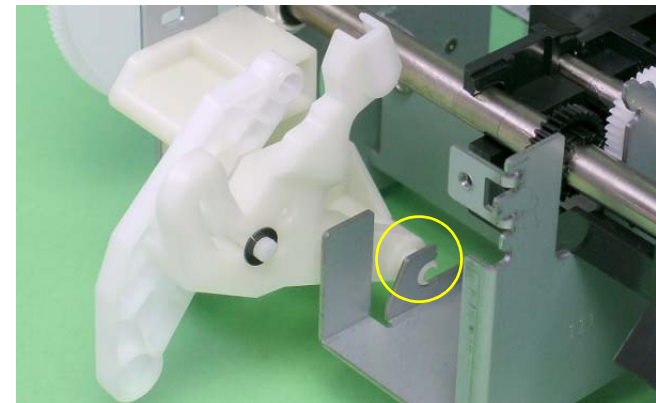

Figure 4-96. Removing the Left CD-R Release Lever Sub Assy (2)

- Align the two tabs on the Left CD-R Release Lever Sub Assy with the positioning holes on the Main Frame. See Figure 4-94.

4.2.6.9 Ink System Unit

1. For Stylus Photo 1400/1410:
Remove the Right CD-R Release Lever Sub Assy. See section 4.2.6.8 on page 107.
For Stylus Photo 1390:
Remove the Printer Mechanism. See section 4.2.1.5 on page 82.
Remove the Paper EJ Frame Assy. See section 4.2.6.7 on page 106.
2. Release the Carriage lock, and move the Carriage Unit to the center. See section 4.2.1.3 on page 79.
3. Remove the C.B.S. 3x8 screw that secures the Earth Cable to remove the Earth Cables, and untie the Earth Cable from the Relay Connector Cable.
4. Disconnect the Pump Motor Connector from the Relay Connector.

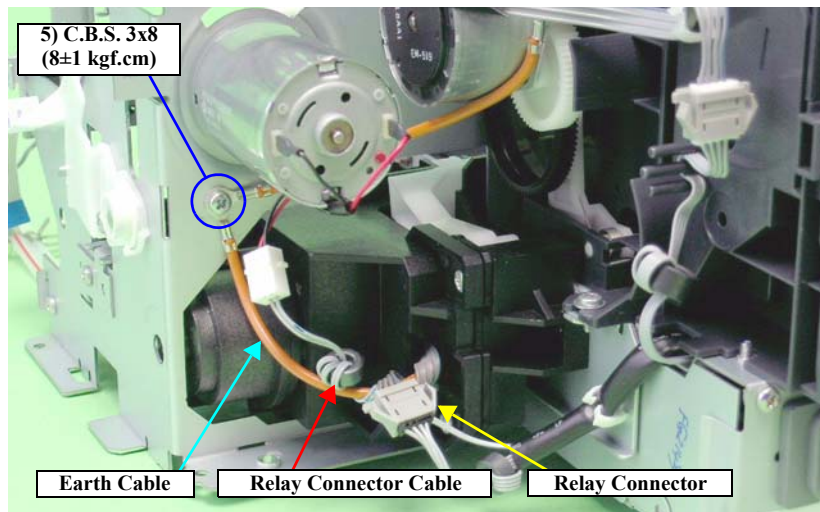

Figure 4-97. Disconnecting the Pump Motor Connector



- Be sure to screw the two Earth Cables together.
- Referring to Figure 4-97, correctly route the Relay Connector Cable.

5. Remove the two C.B.S. 3x4 screws that secure the Ink System Guide Plate, and remove it.

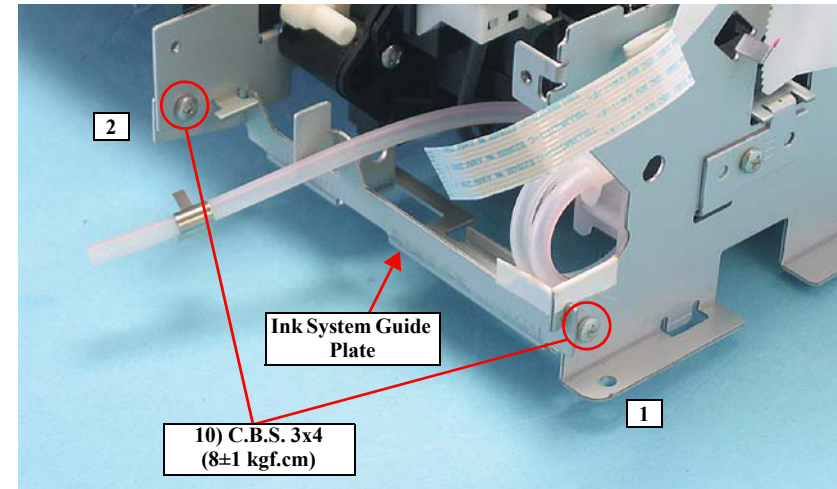

Figure 4-98. Removing the Ink System Guide Plate



- Align the cutout on the Ink System Guide Plate with the cutout on the Main Frame.

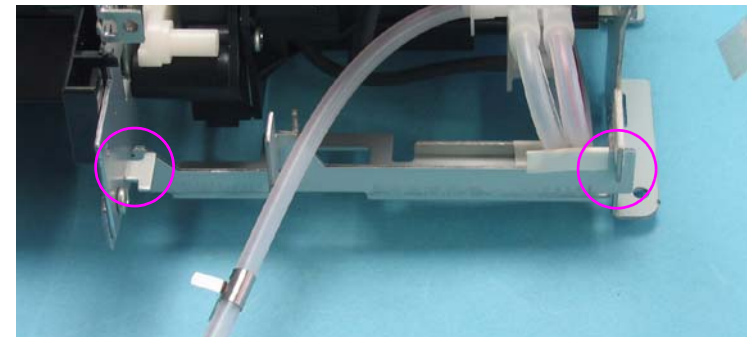

Figure 4-99. Installing the Ink System Guide Plate

- Tighten the screws in the order shown in Figure 4-98.

- Remove the two C.B.S. 3x6 screws that secure the Ink System Unit.

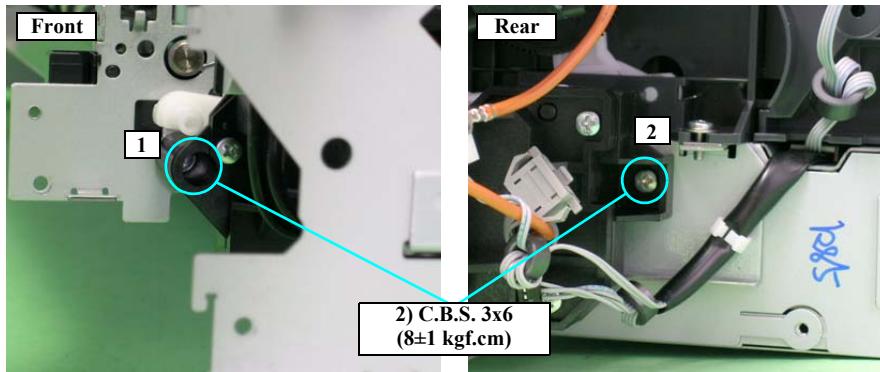

Figure 4-100. Screws that Secure the Ink System Unit



Tighten the screws in the order shown in [Figure 4-100](#).

- Remove the two C.B.S. 3x6 screws that secure the Right Support Frame, and remove the Right Support Frame from the Main Frame.

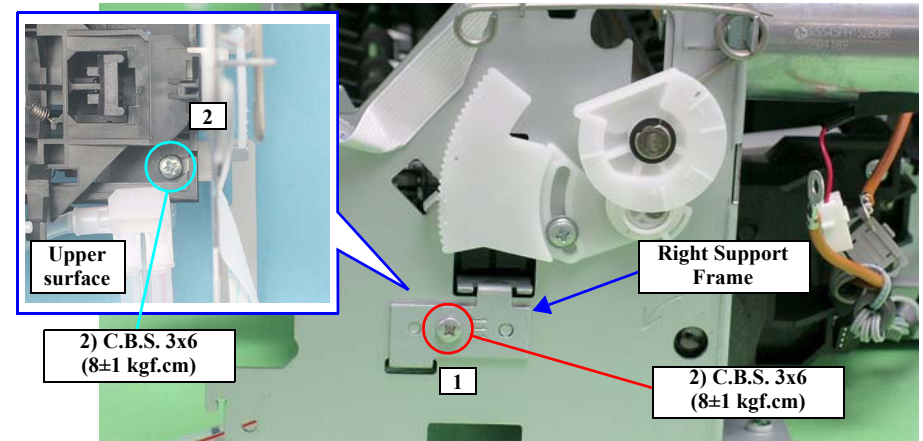

Figure 4-101. Removing the Right Support Frame



- Align the positioning holes on the Right Support Frame with the Guide Pins on the Main Frame.

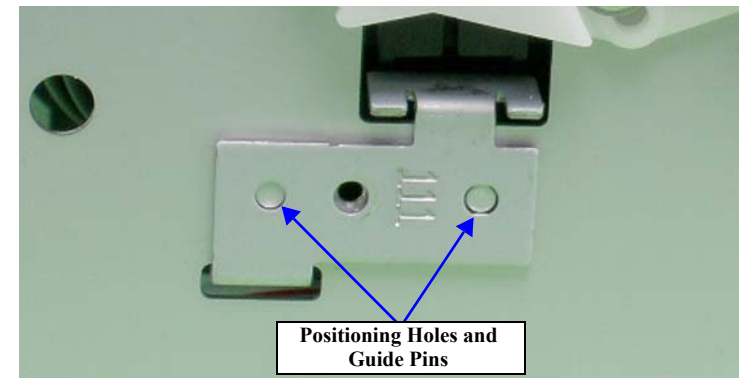

Figure 4-102. Installing the Support Frame (Right)

- Tighten the screws in the order shown in [Figure 4-101](#).

8. Remove the Ink System Unit downwards from the Main Frame. For Stylus 1400/1410, remove it while keeping the Unit from coming in contact with the Paper EJ Transmission Lock Lever.

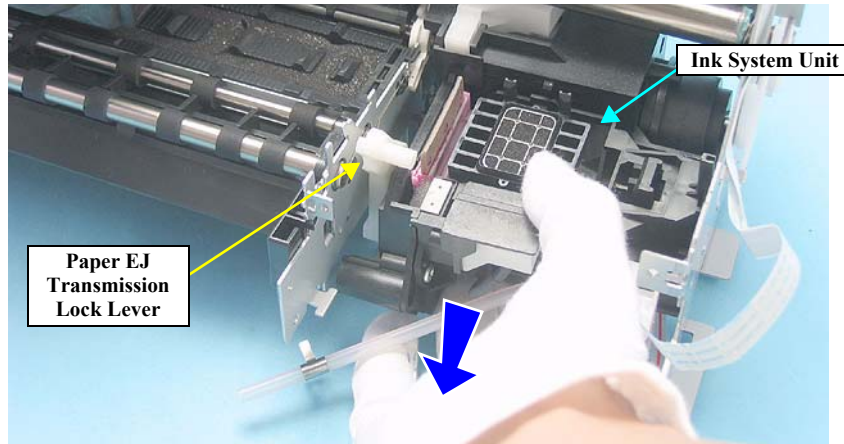

Figure 4-103. Removing the Ink System Unit



When the Ink System Unit is removed from the Printer Mechanism, the Paper EJ Lock Release Cam may drop off. In such case, correctly install it referring to the figure below. (The Stylus Photo 1390 is not equipped with the Paper EJ Lock Release Cam.)

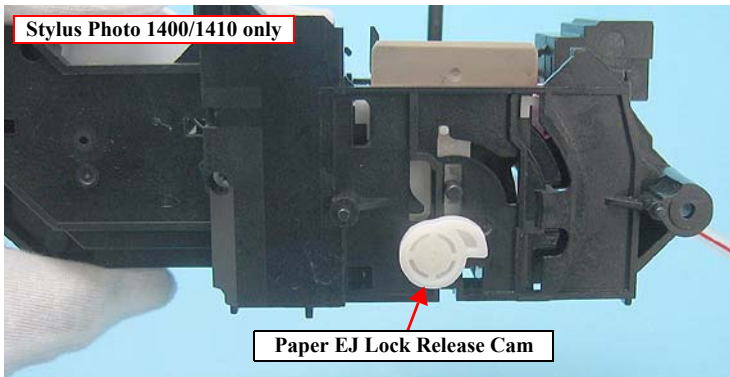

Figure 4-104. Installing the Paper EJ Lock Release Cam



- Place the Paper EJ Lock Release Cam on the rear side of the Paper EJ Transmission Lock Lever. (The Stylus Photo 1390 is not equipped with the Paper EJ Transmission Lock Lever.)

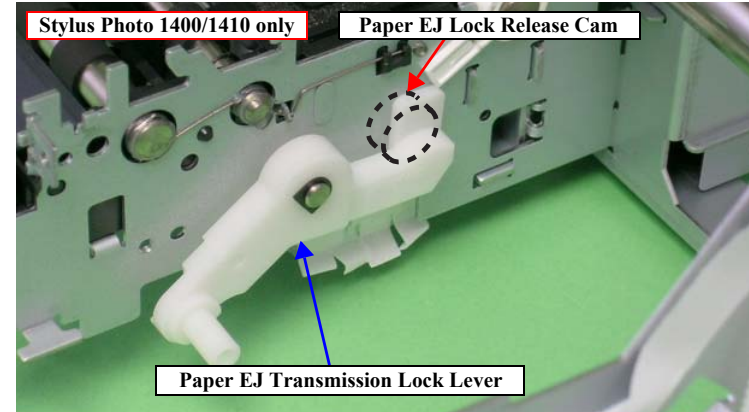

Figure 4-105. Installing the Ink System Unit (1)

- Align the positioning hole on the Main Frame with the guide pin on the Ink System Unit.

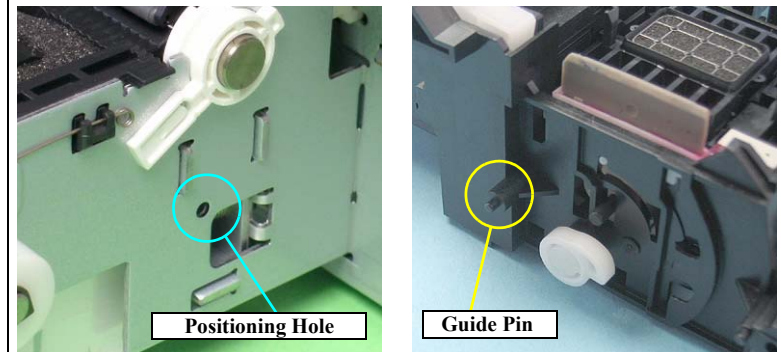

Figure 4-106. Installing the Ink System Unit (2)

4.2.6.10 Release Holder Assy

1. Remove the ASF Assy. See Section 4.2.4 on page 86.
2. Release the PE Sensor Connector Cable from the five tabs on the Release Holder Assy.
3. Remove the three C.B.S. 3x6 screws that secure the Release Holder Assy.
4. Remove the three lower tabs of the Release Holder Assy from the Main Frame with a flat-blade screwdriver, and remove the Release Holder Assy upwards.

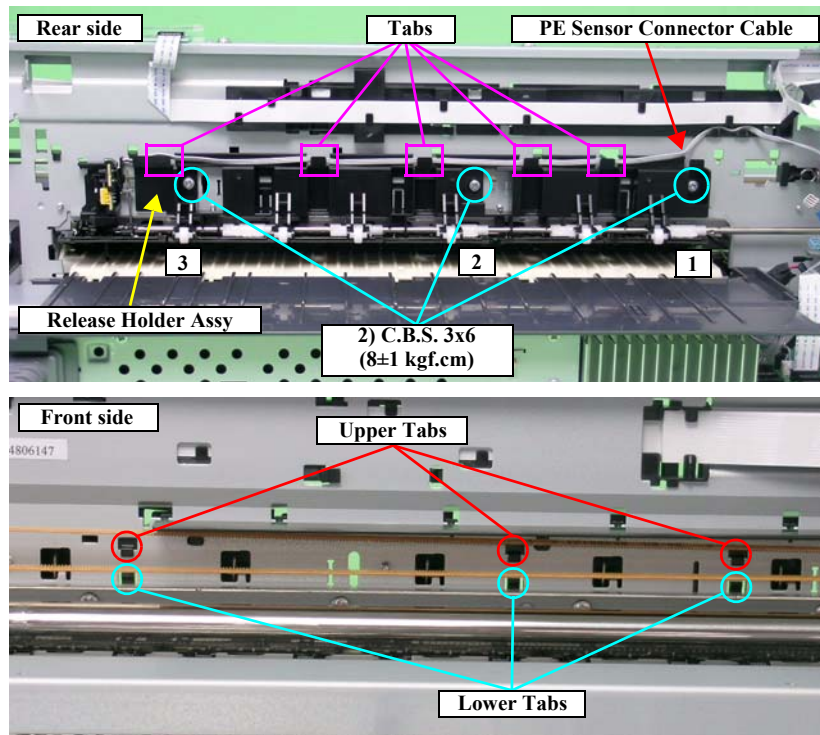

Figure 4-107. Removing the Release Holder Assy



- Align the three Upper tabs on the Release Holder Assy with the positioning holes on the Main Frame. See Figure 4-107.
- Fit the FLAG Release Shaft by the Bushings on the Release Holder Assy.

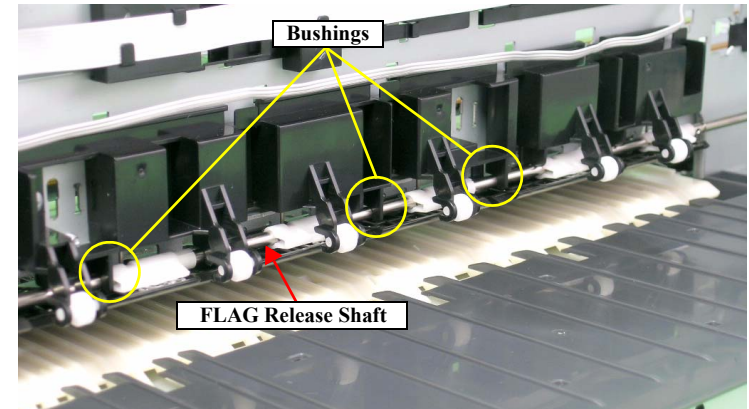

Figure 4-108. Reinstalling the Release Holder Assy

- Tighten the screws in the order shown in Figure 4-107.

4.2.6.11 FLAG Release Assy

1. Remove the APG Assy. See Section 4.2.6.4 on page 96.
2. Remove the Release Holder Assy. See Section 4.2.6.10 on page 113.
3. Remove the Guide Pin on the Driven Release Holder from the Main Frame using tweezers, and slide the Driven Release Holder to the left as viewed from the front of the Printer Mechanism.

4. Release the three tabs on the Driven Release Holder from the Main Frame, and remove the FLAG Release Assy.



In the following procedure, the Parallel Pin 1.5 may drop off when you slide the Driven Release Holder. Be careful not to lose the pin.

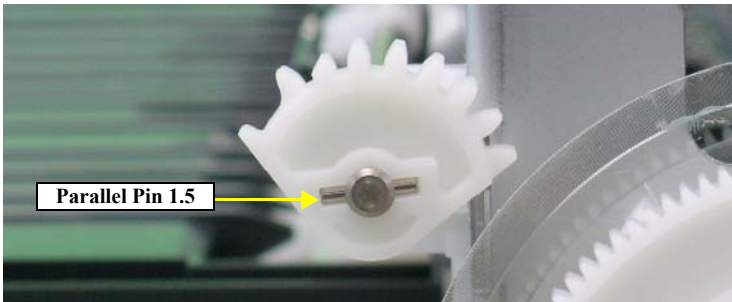

Figure 4-109. Parallel Pin 1.5

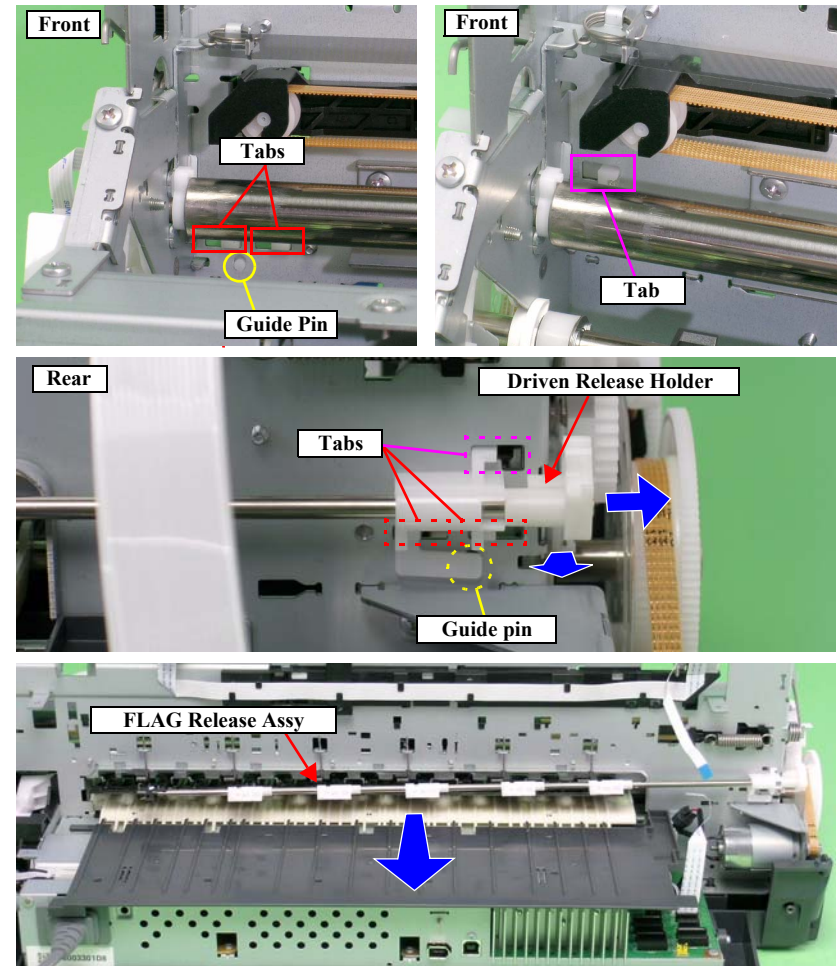

Figure 4-110. Removing the FLAG Release Assy



To avoid ink getting on the LD Roller, attach five Perforated Sheets and the LD Cover Sheet to the six location shown in the figure below.

- Remove the five Paper Guide Torsion Springs from the tabs, insert the cutouts of the Perforated Sheets into the tabs to attach them to the Main Frame, and then hook the Paper Guide Torsion Springs onto the tabs again.
- Insert the LD Cover Sheet in between the frame so that the tabs on the upper side of the LD Cover Sheet are visible from the cutouts on the Main Frame, and attach the LD Cover Sheet.

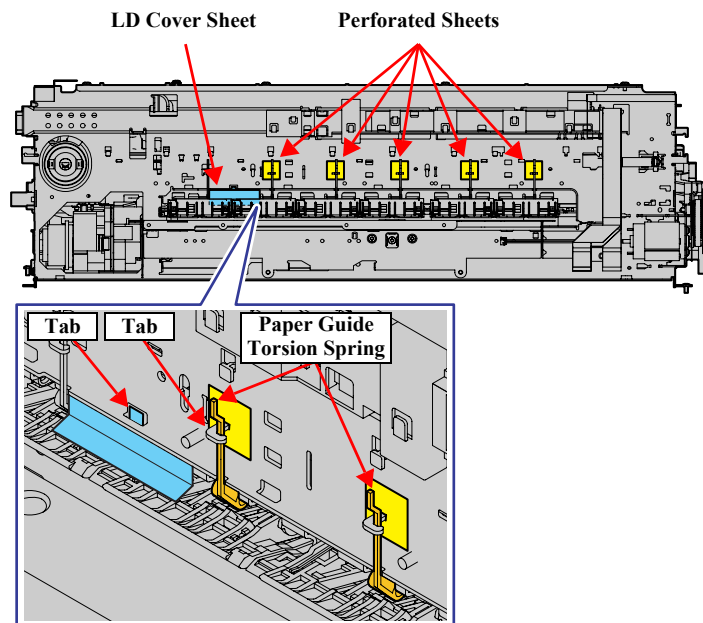

Figure 4-111. Attaching the Perforated Sheets and the LD Cover Sheet

4.2.6.12 Upper Paper Guide Assys

1. Remove the FLAG Release Assy. See Section 4.2.6.11 on page 114.
2. Remove the PE Sensor Holder. See Section 4.2.8.1 on page 124.
3. Pass a sheet of A3 size paper into the gap between the Upper Paper Guide Assy and the Rear Paper Guide.

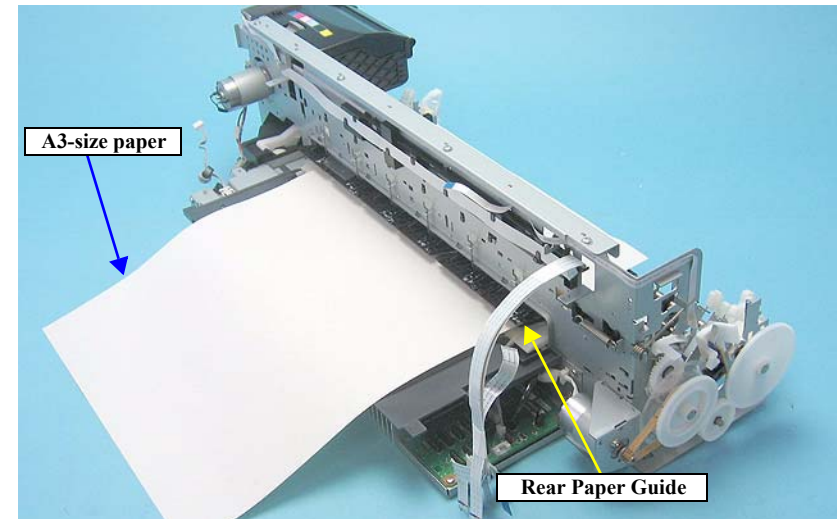

Figure 4-112. Setting the Paper

- Remove the six upper Paper Guide Torsion Springs from the tabs on the Main Frame, and draw out the Upper Paper Guide Torsion Springs from the six Upper Paper Guide Assys.

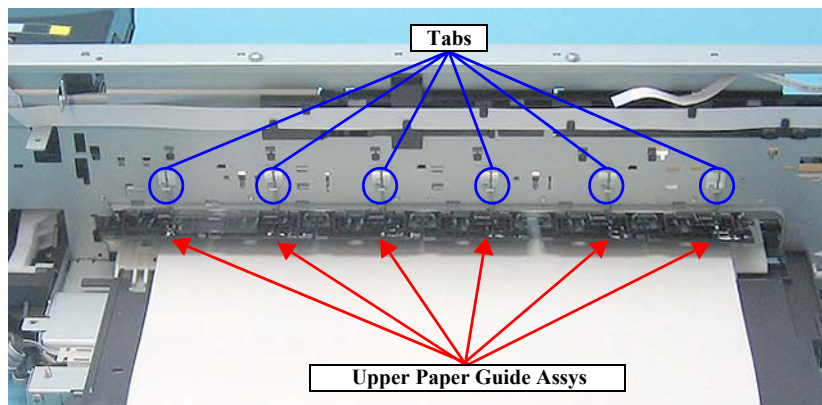
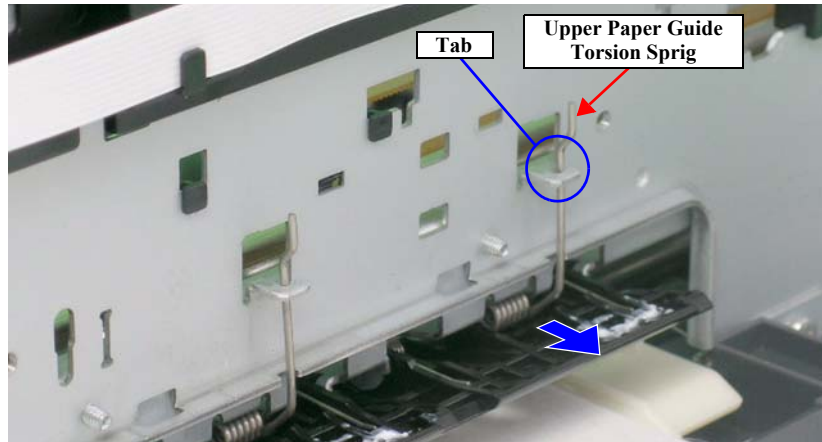

Figure 4-113. Removing the Upper Paper Guide Torsion Spring



Make sure that the leading end of the Upper Paper Guide Torsion Spring can be seen through the hole of the Upper Paper Guide Assy.

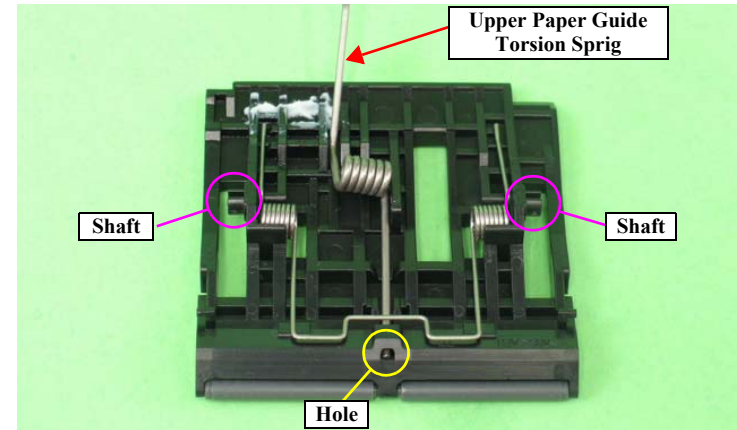

Figure 4-114. Installing the Upper Paper Guide Torsion Spring

- Lift the six Upper Paper Guide Assys from the Main Frame to release the shaft (See Figure 4-114), and remove the Upper Paper Guide Assys to the rear.

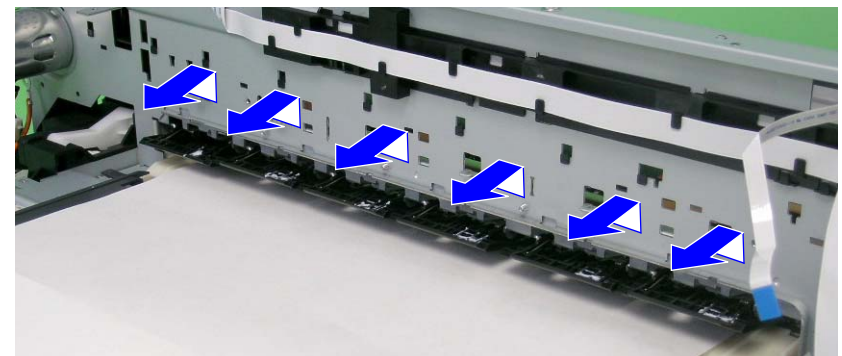

Figure 4-115. Removing the Top Paper Guide Assy



After replacing the following part, be sure to apply G-26 grease to the area specified for each part.

- Upper Paper Guide Assy (p.153)

4.2.6.13 Front Paper Guide and Paper Eject Roller

1. Remove the Paper EJ Frame Assy.
 For Stylus Photo 1400/1410: See section 4.2.1.3 on page 79.
 For Stylus Photo 1390: See section 4.3.1 on page 128.
2. Release the Carriage Lock, and move the Carriage Unit to the center.
 See section 4.2.1.3 on page 79.
3. Remove the EJ Grounding Spring from the Main Frame with tweezers.

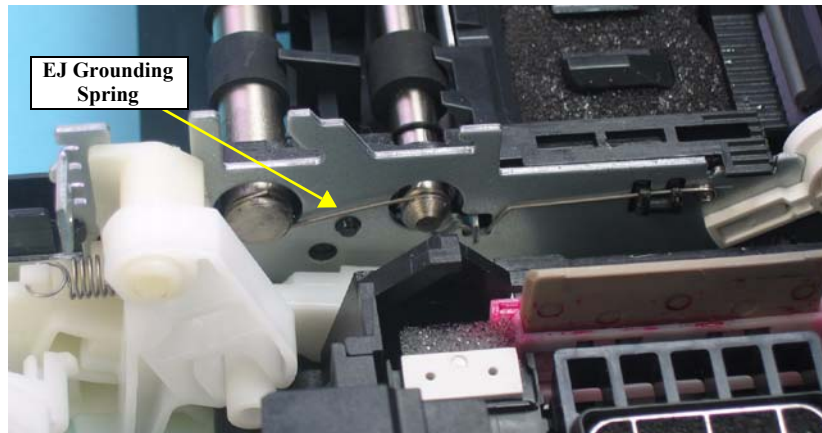

Figure 4-116. Removing the EJ Grounding Spring



Referring to [Figure 4-117](#), correctly install the EJ Grounding Spring.

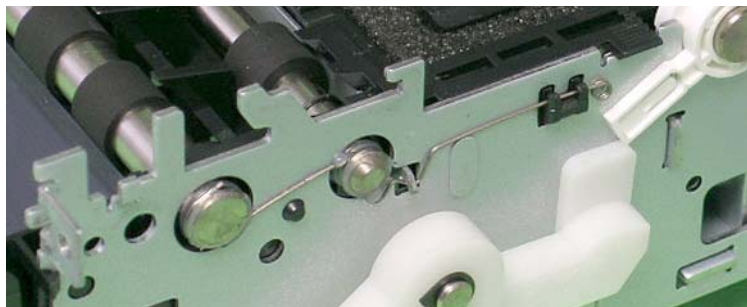

Figure 4-117. Installing the EJ Grounding Spring

4. Remove the Spacer from the EJ Roller Shaft.
5. Remove the Guide Pins on Left Bushing 8 from the Main Frame using tweezers, and turn Left Bushing 8 toward you to align with the cutouts on the Main Frame.

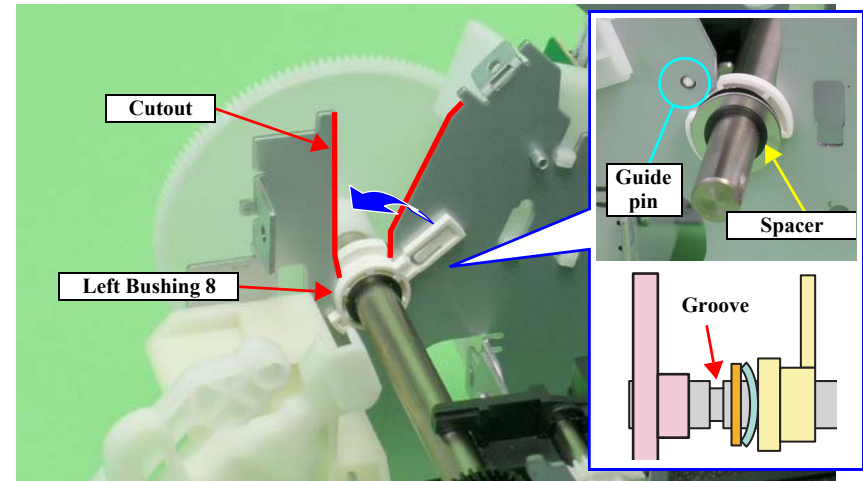

Figure 4-118. Removing the Spacer and Rotating the Left Bushing 8



Insert the Spacer into the groove on the Front Paper Eject Roller.

6. Slide the Front Paper Eject Roller to the left, and remove the Left Bushing 8 from the Main Frame.

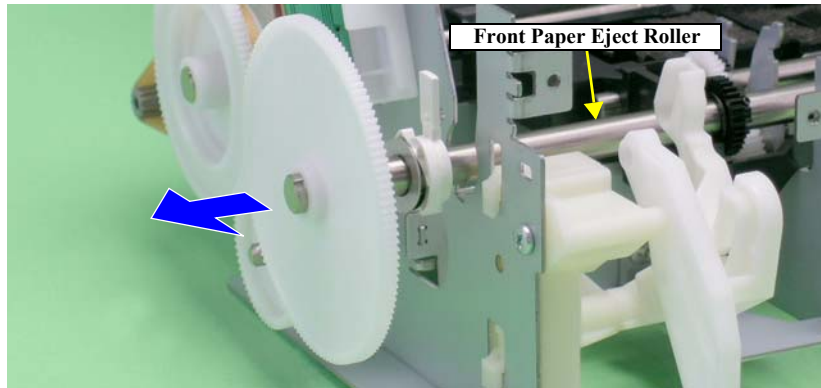

Figure 4-119. Removing the Left Bushing 8

7. Return the Carriage Unit to its home position.
8. Release the tab that secures the Front Paper Guide from the Main Frame and slide the Front Paper Guide to the left, and turn it until the front side faces up to remove the Front Paper Guide together with the Paper Eject Roller.

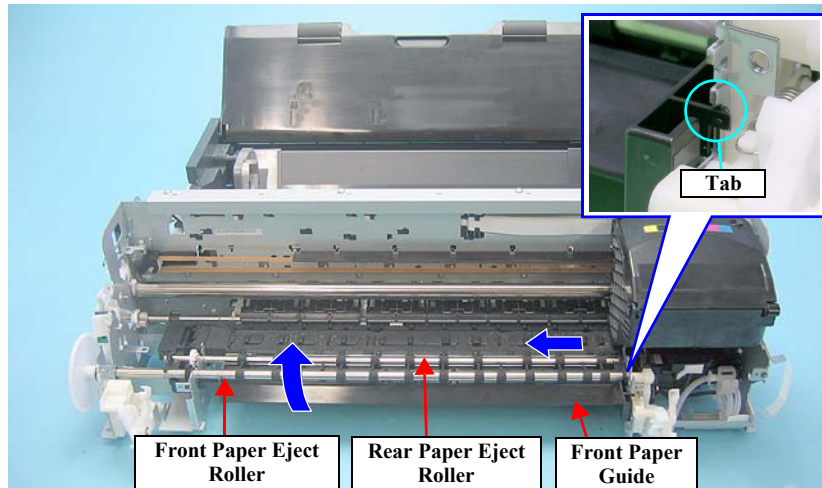

Figure 4-120. Removing the Front Paper Guide and Paper Eject Rollers



- Align the Bushing of the Front Paper Guide with the PF Roller Shaft.

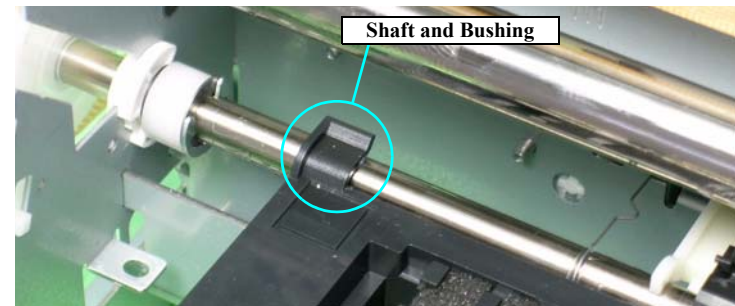

Figure 4-121. The PF Roller Shaft and the Bushing of the Front Paper Guide

- Align the positioning holes on the Main Frame with the Guide Pins on the Front Paper Guide.

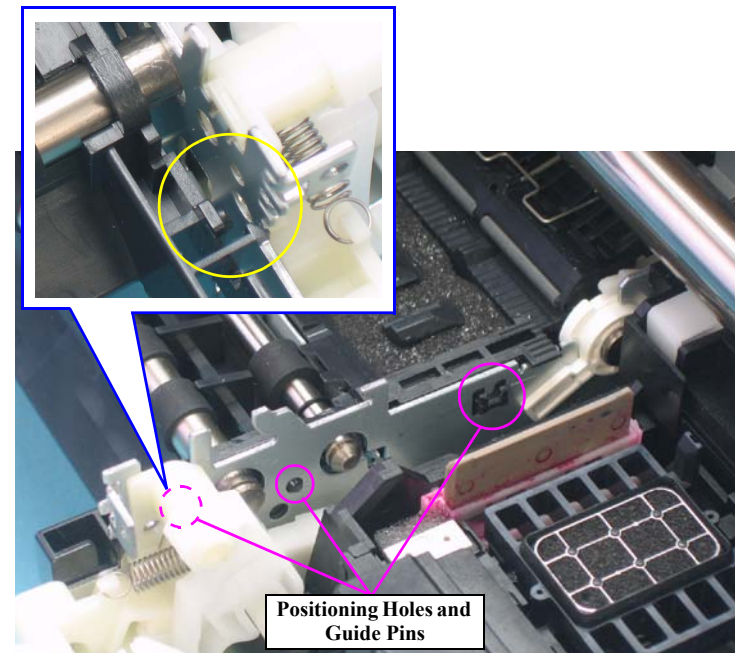

Figure 4-122. Installing the Front Paper Guide



After installing the Front Paper Guide, lift the Printer Mechanism to check the following points.

1. Make sure that the tabs on the Paper Guide Pad are not cut midway.
2. Make sure that all tabs are facing down (toward the Waste Ink Pads) without any folds.
3. Make sure that the turned edges of the tabs are protruding completely from the Front Paper Guide.



Figure 4-123. Checking the Front Paper Guide Pad



■ After replacing the following part, be sure to apply G-45 grease to the area specified for each part.

- EJ Grounding Spring (p.153)
- Front Paper Guide and Paper Eject Roller (p.153)

■ After replacing or removing the Front Paper Guide, the following adjustment must be performed.

1. PW Sensor Adjustment (p.133)
2. PF Adjustment (p.133)
3. PF Adjustment (Bottom Margin) (p.133)

Refer to Chapter 5 “Adjustment” for details on the adjustments.

4.2.6.14 PF Roller Shaft

1. Remove the Upper Paper Guide Assys. See Section 4.2.6.12 on page 115.
2. Remove the PF Encoder Sensor Holder. See Section 4.2.8.4 on page 126.
3. Remove the Front Paper Guide and Paper Eject Roller. See Section 4.2.6.13 on page 117.
4. Loosen the two C.C. 3x4 screws that secure the PF Motor, and remove the PF Drive Belt from the PF Motor Pinion Gear.
5. Remove the Spacer that secures Spur Gear 31.5, and remove Spur Gear 31.5 from the Printer Mechanism.

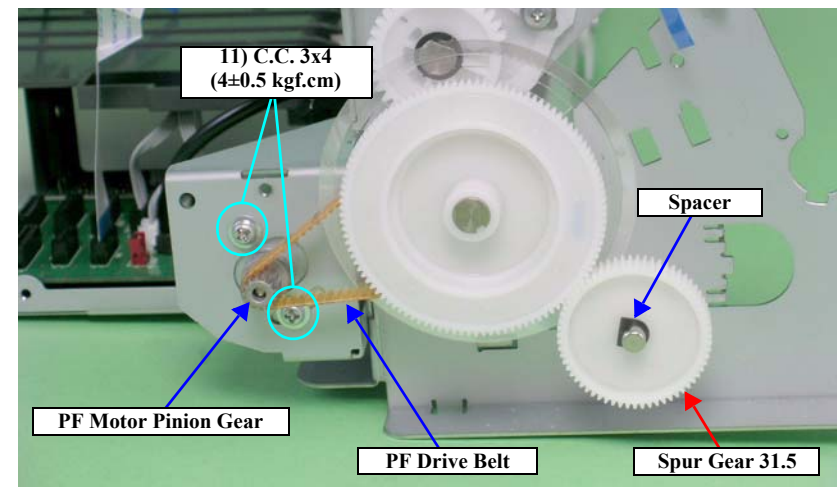

Figure 4-124. Removing the PF Drive Belt and Spur Gear 31.5

- Remove the PG Grounding Spring from the cutout of the Main Frame, and remove the PF Grounding Spring from the groove of the PF Roller Shaft.

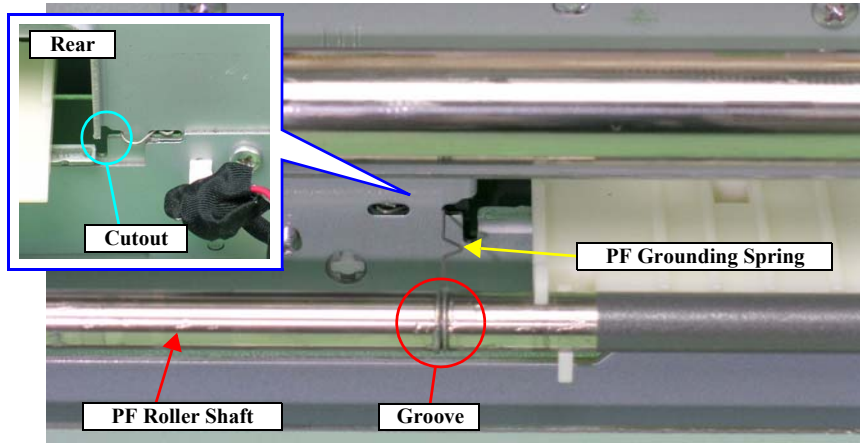

Figure 4-125. Removing the PF Grounding Spring

- Make sure that the Left Parallelism Adjust Bushing is not protruding from the cutout of the Main Frame. If it is protruding, loosen the C.B.S. (P4) 3x8 screw that secures the Left Parallelism Adjust Bushing, and slide it to prevent the Left Parallelism Adjust Bushing from becoming hooked on the cutout.

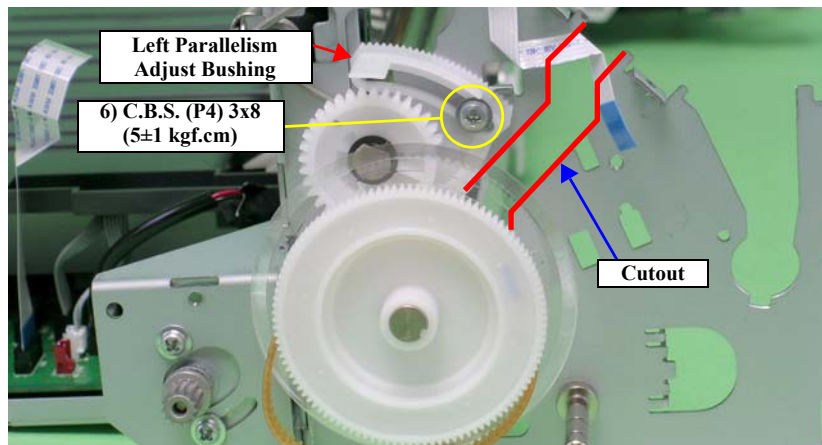

Figure 4-126. Rotating the Left Parallelism Adjust Bushing

- Remove the Guide Pin of Left Bushing 8 from the Main Frame using tweezers, and rotate the Bushing upwards to align with the cutout on the Main Frame.

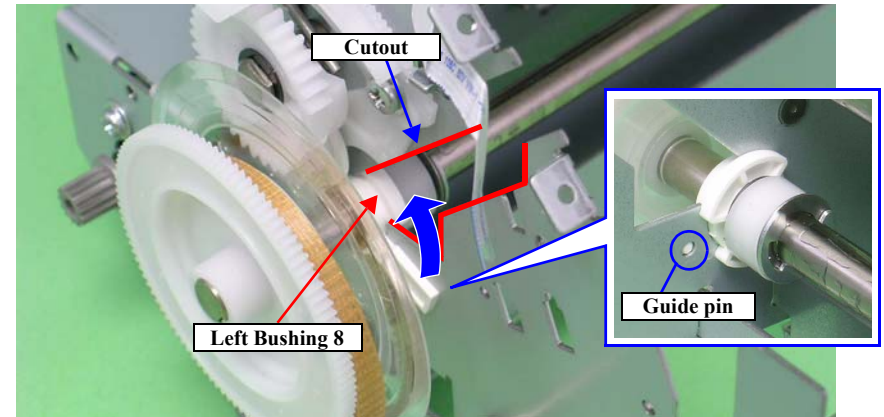

Figure 4-127. Rotating the Left Bushing 8

CAUTION 	<p>When performing the following procedure, take care not to lose the E-ring.</p>
---	--

- Remove the E-ring from the PF Roller Shaft with a flat-blade screwdriver, and slide Left Bushing 8 to the inside of the Printer Mechanism.

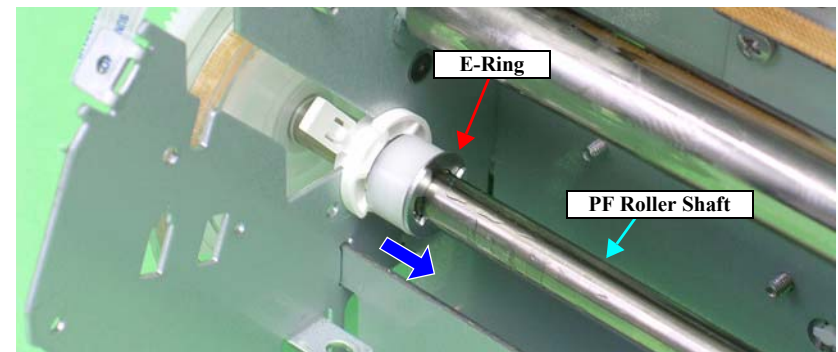

Figure 4-128. Removing the Left Bushing 8



When performing the following procedure, pay attention to the following points.

- Prevent the coated surface of the PF Roller Shaft from being scratched.
- Do not touch the coated surface of the PF Roller Shaft with bare hands.

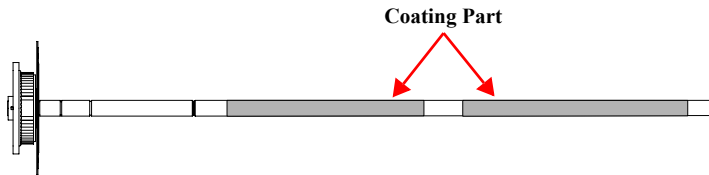

Figure 4-129. Handling the PF Roller Shaft



Be careful not to move Compression Spring 4 and the Leaf Spring on the left side of the PF Roller Shaft to the coated section on the Shaft after removing the PF Roller Shaft.



Figure 4-131. Handling the PF Roller Shaft

10. Remove the PF Roller Shaft from the Bushings on the Rear Paper Guide and the Center Support, slide the PF Roller Shaft to the left to remove it from Right Bushing 8, and remove the PF Roller Shaft along the cutout of the Main Frame.

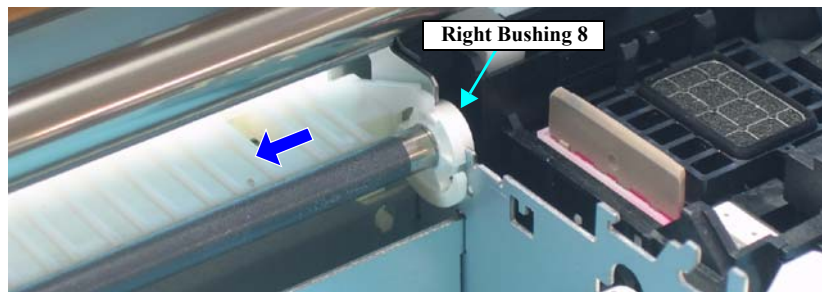
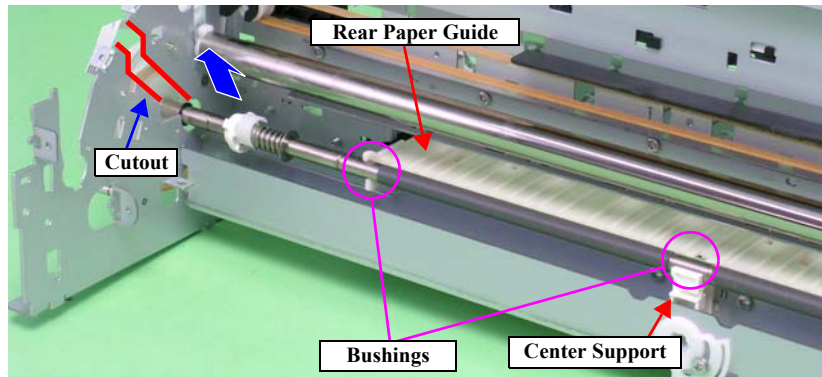

Figure 4-130. Removing the PF Roller Shaft



- After replacing the following part, be sure to apply G-45 grease to the area specified for each part.
 - PF Roller Shaft (p.153)
 - Rear Paper Guide (p.154)
 - PF Grounding Spring (p.154)
- After replacing or removing the PF Roller Shaft, the following adjustment must be performed.
 1. PF Belt Tension Adjustment (p.132)
 2. PF Roller Shaft Center Support Position Adjustment (p.132)
 3. PG Adjustment (Only when moved the Left Parallelism Adjust Bushing) (p.132)
 4. PW Sensor Adjustment (p.133)
 5. PF Adjustment (p.133)
 6. PF Adjustment (Bottom Margin) (p.133)

Refer to Chapter 5 “Adjustment” for details on the adjustments.

4.2.7 Removing the Motors

4.2.7.1 CR Motor

1. Remove the Upper Housing.
For Stylus Photo 1400/1410: See section 4.2.1.4 on page 80.
For Stylus Photo 1390: See section 4.3.1 on page 128.
2. Release the Carriage lock, and move the Carriage Unit to the center.
See section 4.2.1.3 on page 79.
3. Disconnect the CR Motor Connector Cable from the Relay Connector.

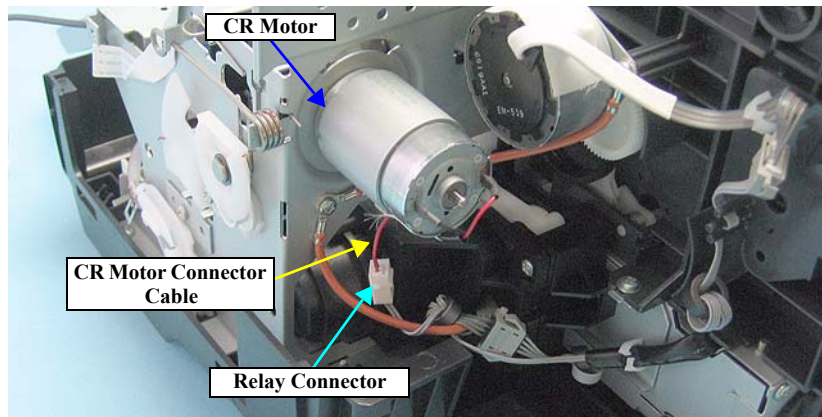
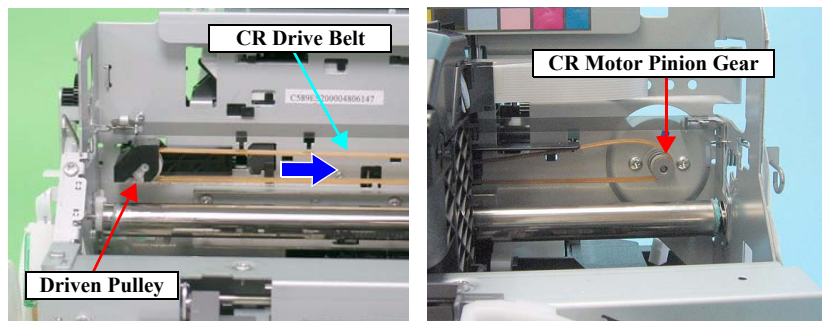

Figure 4-132. Removing the CR Motor Connector Cable

4. Push the Driven Pulley toward the center to loosen the CR Drive Belt, and remove the CR Drive Belt from the CR Motor Pinion Gear.



5. Remove the two C.B.S. 3x4 screws that secure the CR Motor, and remove the CR Motor from the Main Frame.

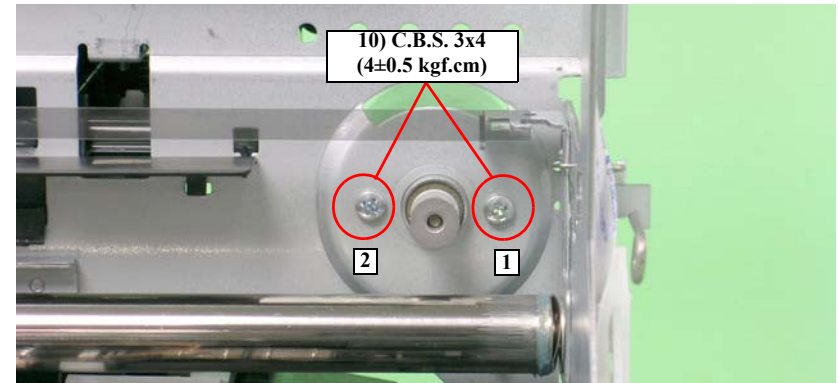

Figure 4-133. Removing the CR Motor



- Face the Lot No. printed surface of the CR Motor as shown in Figure 4-134.

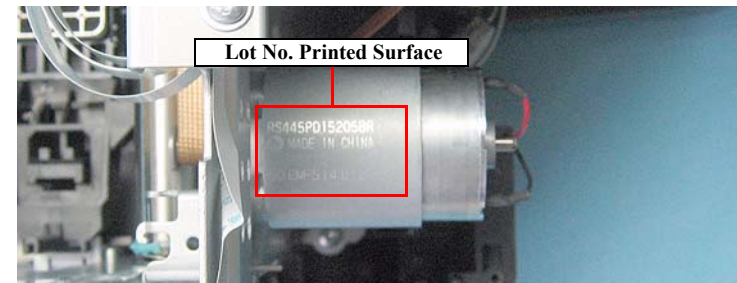

Figure 4-134. Installing the CR Motor

- Tighten the screws in the order shown in Figure 4-133.



After replacing the CR Motor, the following adjustment must be performed.

- CR Motor Drive Dispersion (p.133)
Refer to Chapter 5 “Adjustment” for details on the adjustments.

4.2.7.2 PF Motor

1. Remove the Printer Mechanism. See section 4.2.1.5 on page 82.
2. Disconnect the PF Motor Connector Cable from Connector CN7 (black) on the Main Board, and remove it from the Clamp on the Main Frame.
3. Remove the two C.C. 3x4 screws that secure the PF Motor.
4. Remove the PF Drive Belt from the PF Motor Pinion Gear, and remove the PF Motor from the Printer Mechanism.

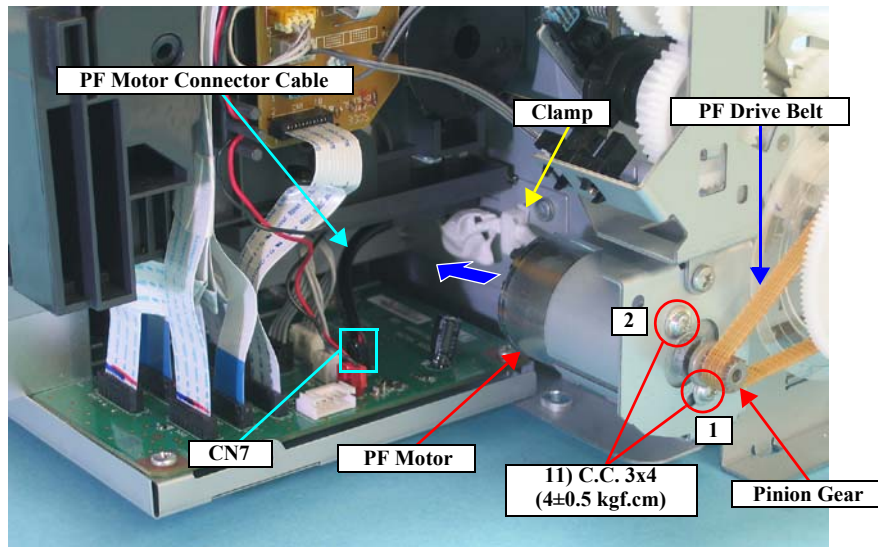

Figure 4-135. Removing the PF Motor

REASSEMBLY



- Face the slit of the PF Motor as shown in Figure 4-136.

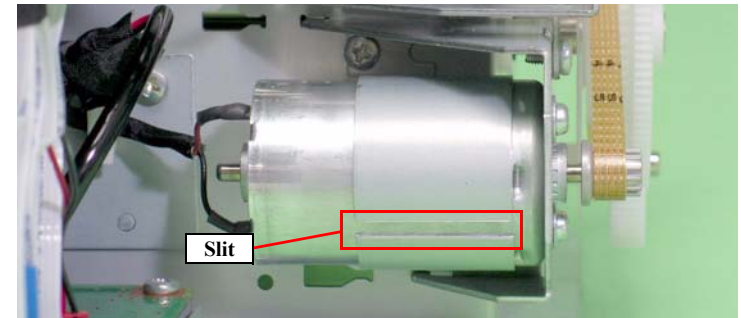

Figure 4-136. Installing the PF Motor

- Tighten the screws in the order shown in Figure 4-135.

ADJUSTMENT REQUIRED



After replacing or removing the PF Motor, the following adjustment must be performed.

1. PF Belt Tension Adjustment (p.132)
2. PF Roller Shaft Center Support Position Adjustment (p.132)
3. PF Adjustment (p.132)
4. PF Adjustment (Bottom Margin) (p.133)

Refer to Chapter 5 “Adjustment” for details on the adjustments.

4.2.8 Removing the Sensors

4.2.8.1 PE Sensor Holder

1. Remove the ASF Assy. See Section 4.2.4 on page 86.
2. Remove the PE Sensor Connector Cable from the five tabs on the Release Holder Assy and the two tabs on the Head Cable Cover.

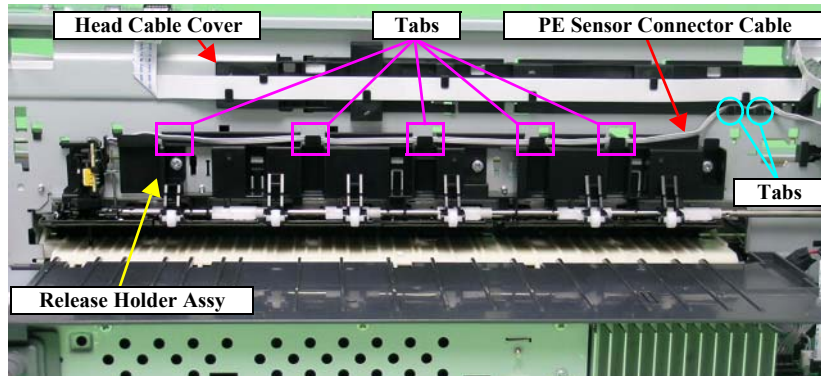

Figure 4-137. Releasing the Cables

3. Release the tabs that secure the PE Sensor Holder from the cutout of the Main Frame with a flat-blade screwdriver, then slide it upwards then toward you to remove it.

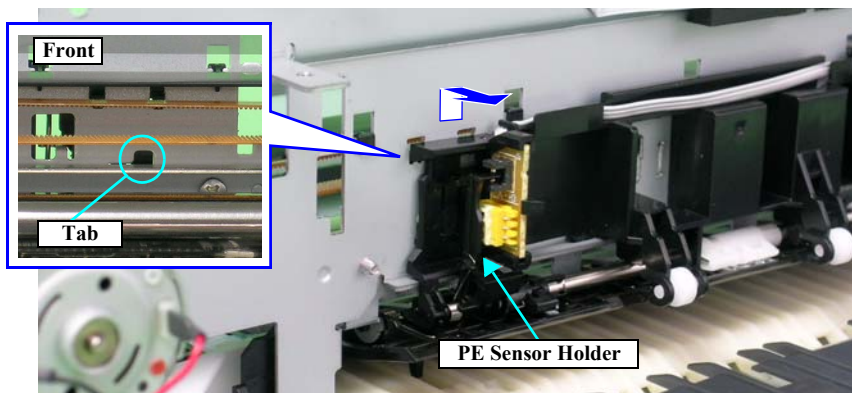

Figure 4-138. Removing the PE Sensor Holder



Align the four tabs and Guide Pin on the PE Sensor Holder with the positioning holes on the Main Frame correctly so that there is no gap between the PE Sensor Holder and the Main Frame.

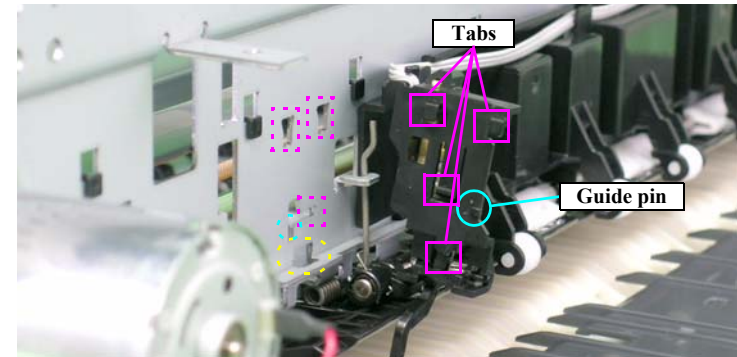

Figure 4-139. Installing the PE Sensor

4.2.8.2 PW Sensor

1. Remove the Carriage Unit. See section 4.2.6.5 on page 98.
2. Remove the C.P.B. (P1) 1.7x5 screw that secures the PW Sensor Holder, and remove the PW Sensor Holder from the Carriage Unit.

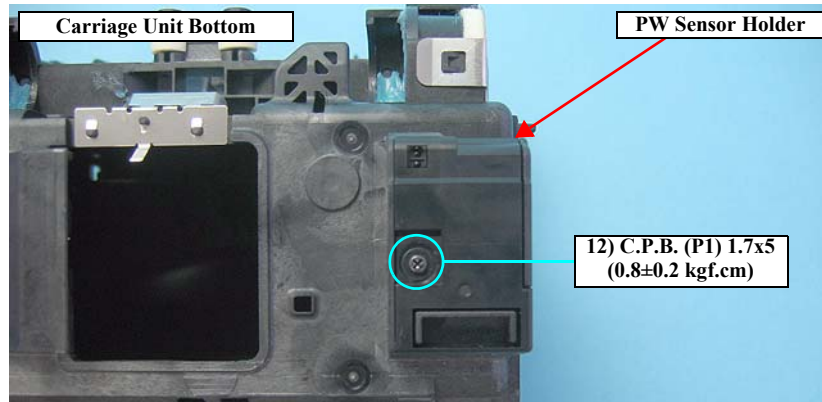

Figure 4-140. Removing the PW Sensor Holder

3. Disconnect the FFC from the PW Sensor, and remove the PW Sensor.

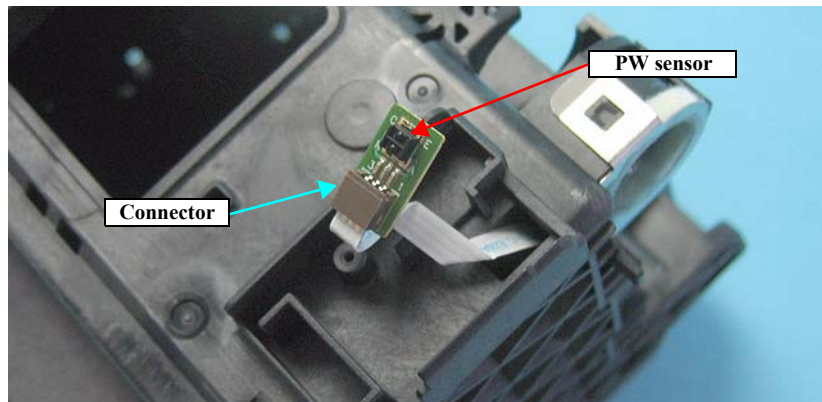

Figure 4-141. Removing the PW Sensor



Make sure that the FFC is routed as shown in [Figure 4-141](#).



After replacing or removing the PW Sensor, the following adjustment must be performed.

- PW Sensor Adjustment ([p.133](#))
Refer to Chapter 5 “Adjustment” for details on the adjustments.

4.2.8.3 CR Encoder Sensor Board

1. Remove the Carriage Unit. [See section 4.2.6.5 on page 98.](#)
2. Remove the two C.B.P. 2.6x5 screws that secure the CR Encoder Sensor Board.
3. Disconnect the FFC of PW Sensor from the Connector of the CR Encoder Sensor Board, and remove the CR Encoder Sensor Board.

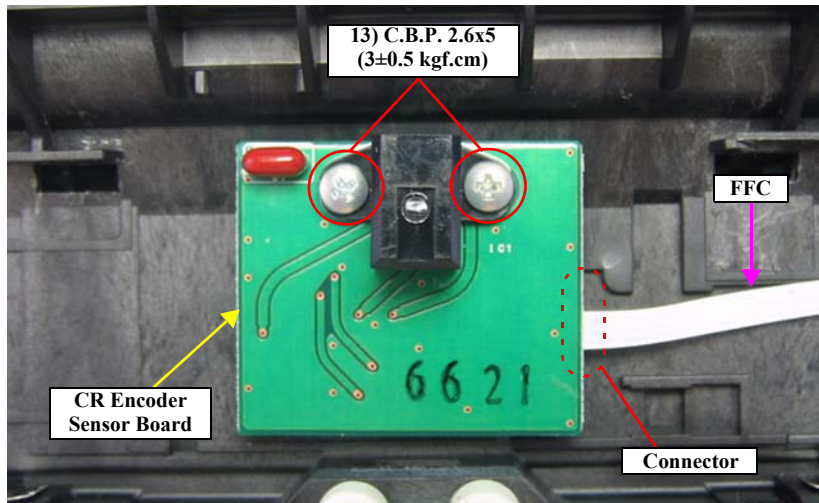

Figure 4-142. Removing the CR Encoder Sensor Board

4.2.8.4 PF Encoder Sensor Holder

1. Remove the Upper Housing.
For Stylus Photo 1400/1410: [See section 4.2.1.4 on page 80.](#)
For Stylus Photo 1390: [See section 4.3.1 on page 128.](#)
2. Disconnect the FFC from the PF Encoder Sensor Board.
3. Remove the C.B.S. M3 x 8 screw that secures the PF Encoder Sensor Holder.

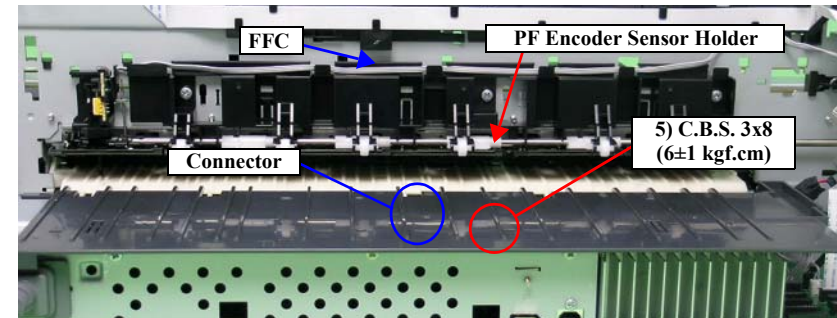

Figure 4-143. Removing the FFC and the Screw that Secures the PF Encoder Sensor Holder

4. While pressing the Guide Pin on the PF Encoder Sensor Holder using tweezers, slide the Holder upwards to release the three Tabs, and remove the PF Encoder Sensor Holder.

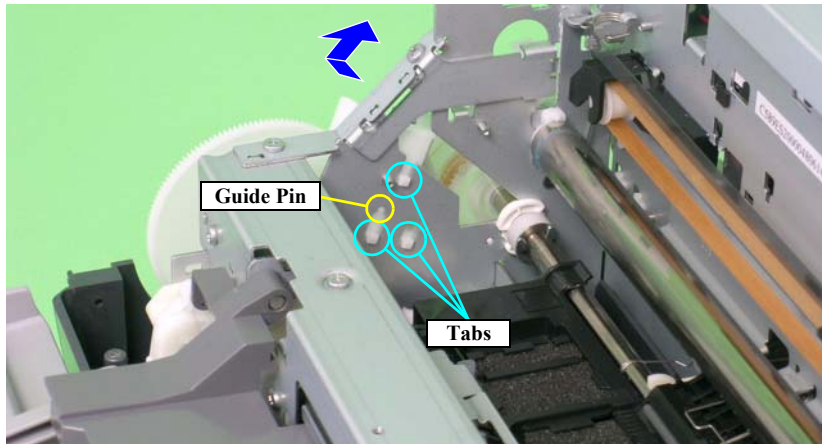

Figure 4-144. Removing the PF Encoder Sensor Holder

REASSEMBLY

Make sure that the PF Scale is in the slit on the PF Encoder Sensor.

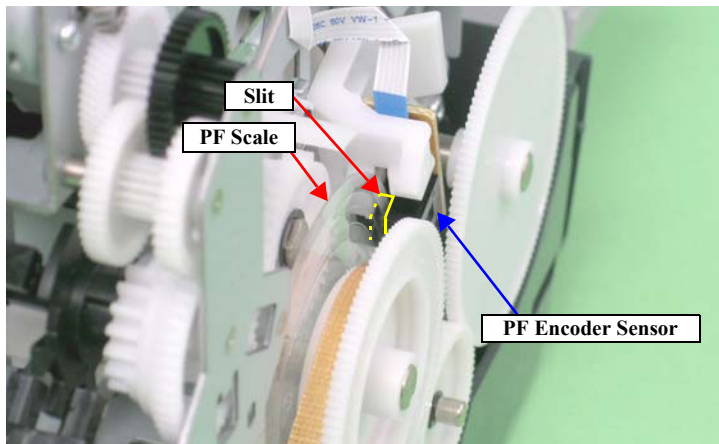

Figure 4-145. Reinstalling the PF Encoder Sensor Holder

4.3 Procedure Specific to Stylus Photo 1390

This section describes disassembly procedures of the Upper Housing and the Paper EJ Frame Assy of Stylus Photo 1390.

4.3.1 Upper Housing

1. Open the Printer Cover and the Paper Support.
2. Remove the two C.B.S. 3x6 screws, and open the Front Cover.

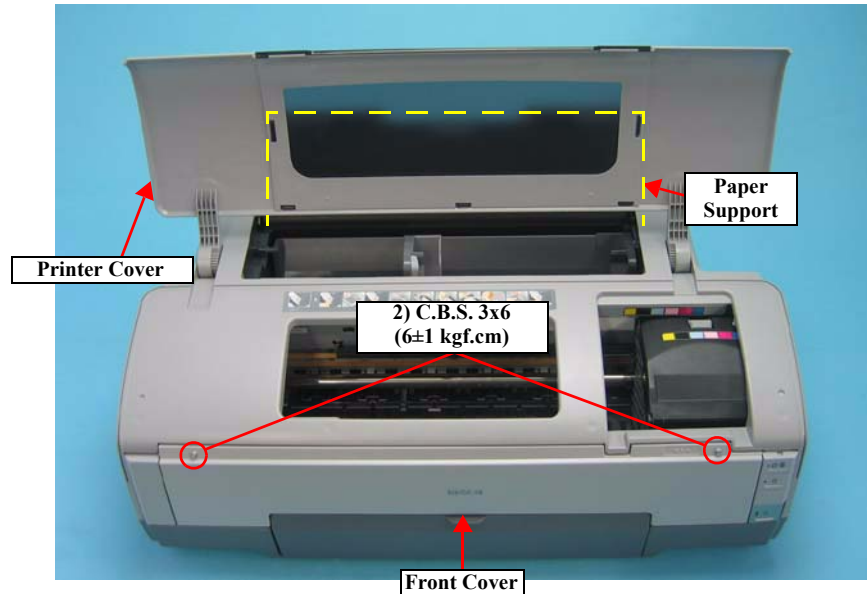

Figure 4-146. Opening the Front Cover

3. Remove the Side Housing. See Section 4.2.1.2 on page 78.
4. Remove the four C.B.P. 3x10 screws, three C.B.S. 3x6 screws, and two C.B.P. 3x10 screws that secure the Upper Housing.

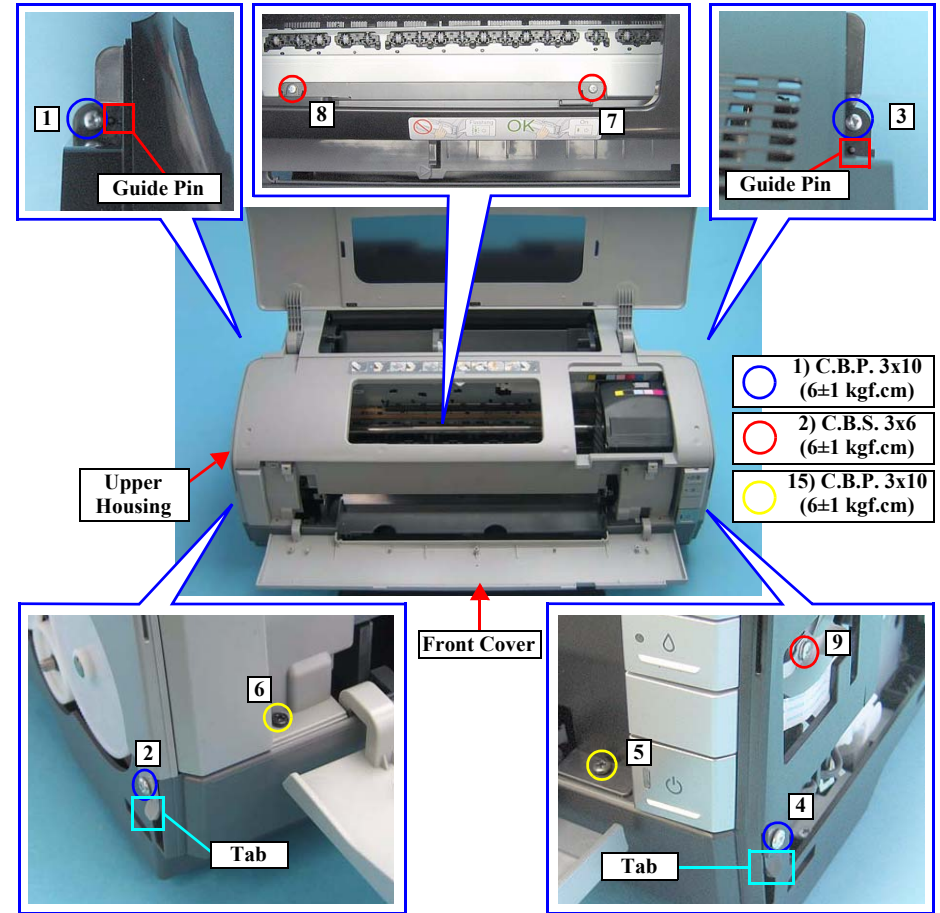

Figure 4-147. Screws that Secure the Upper Housing

5. Disconnect the Panel FFC from connectors CN1 on the Switch Board.

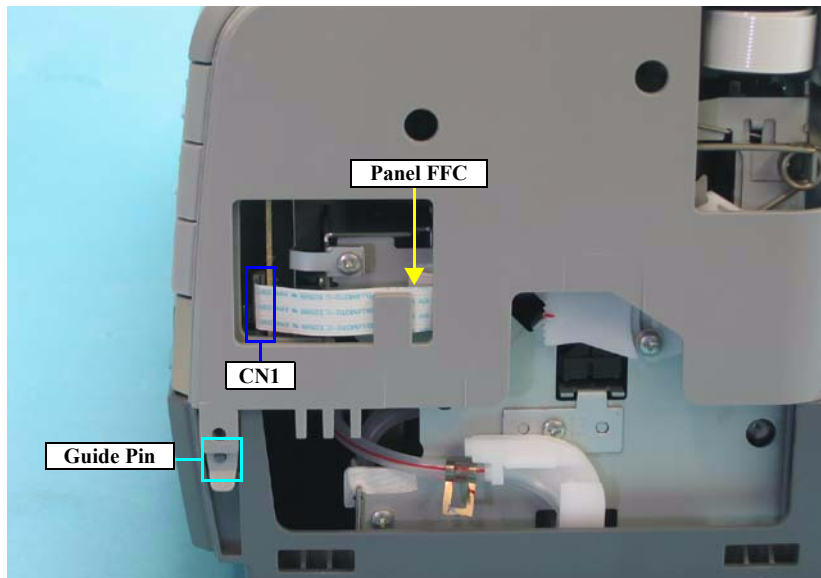

Figure 4-148. Disconnecting the Panel FFC

6. Remove the Guide Pins from the two tabs shown in Figure 4-147, and remove the Upper Housing upwards.



- Align the Guide Pins with the positioning holes of the Upper Housing. See Figure 4-147.
- Tighten the screws in the order shown in Figure 4-147.

4.3.2 Paper EJ Frame Assy

1. Remove the Upper Housing. See section 4.3.1 on page 128.
2. Remove the Left Frame Support Plate. See Step 2 in Section 4.2.6.5 on page 98.
3. Put back the rotation position of the Right PG Cam.
4. Remove the four C.B.S. 3x6 screws that secure the Paper EJ Frame Assy.

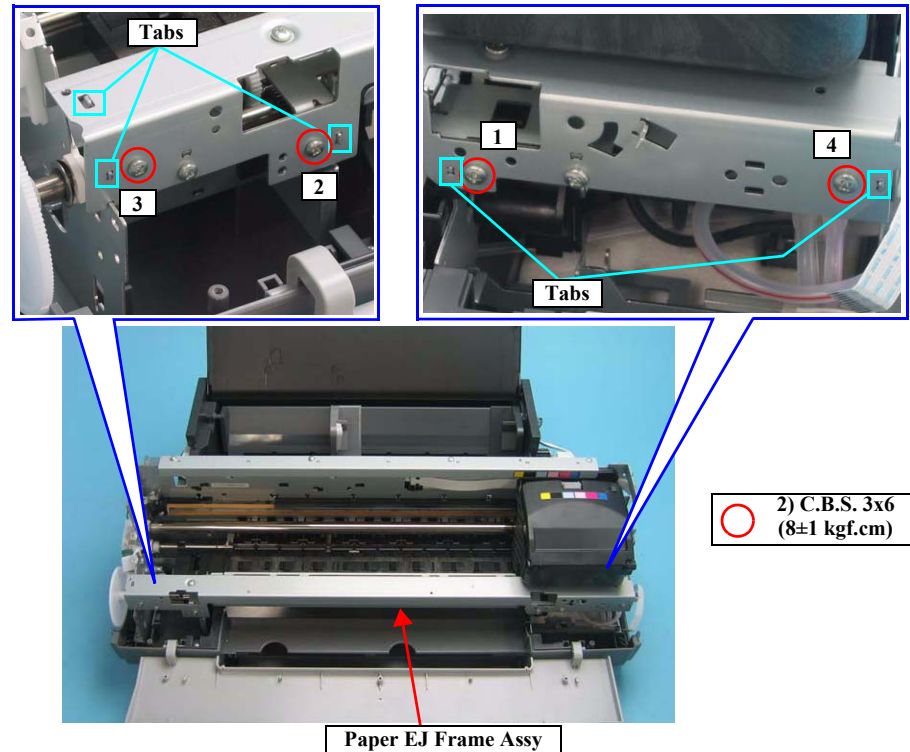

Figure 4-149. Screws that Secure the Paper EJ Frame Assy

CAUTION

When performing the following procedure, take care not to scratch the Star Wheel.

- Pull the Star Wheel Roller toward you, and remove the Paper EJ Frame Assy from the Printer Mechanism.

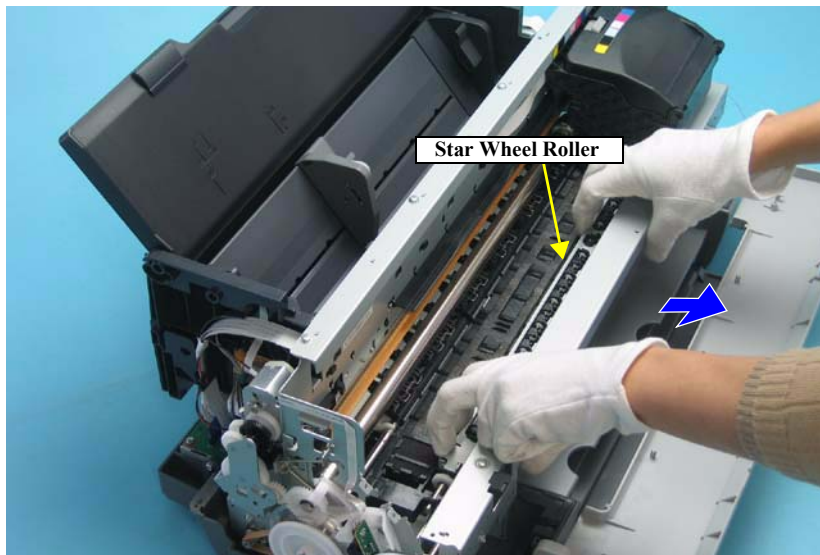

Figure 4-150. Removing the Paper EJ Frame Assy

REASSEMBLY

- Hook both rear ends of the Paper EJ Frame Assy onto the tabs of the Main Frame.

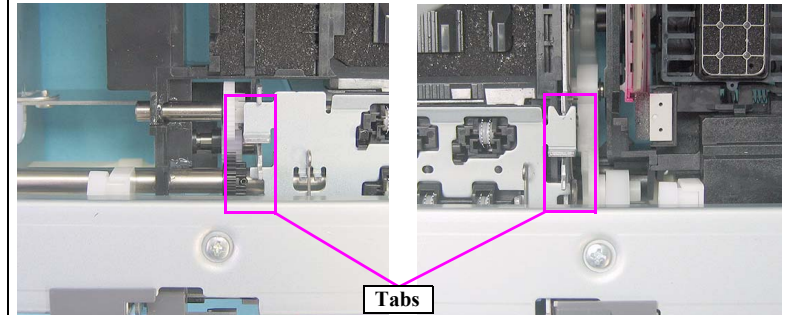

Figure 4-151. Installing the Paper EJ Frame Assy

- Match the tabs with the five Positioning Holes.
See [Figure 4-149](#).
- Tighten the screws in the order shown in [Figure 4-149](#).

**ADJUSTMENT
REQUIRED**

After replacing or removing the Paper EJ Frame Assy, the following adjustment must be performed.

- PW Sensor Adjustment ([p.133](#))
- PF Adjustment ([p.133](#))
- PF Adjustment (Bottom Margin) ([p.133](#))

Refer to Chapter 5 “Adjustment” for details on the adjustments.

CHAPTER

5

ADJUSTMENT

5.1 Adjustment Items and Overview

This chapter describes the adjustments to be made after the disassembly/reassembly of this product.

5.1.1 Servicing Adjustment Item List

The following table describes the items, purposes and outlines of the Adjustment Program.

Table 5-1. Adjustment Items

Adjustment	Purpose	Method Outline
PF Belt Tension Adjustment	To reduce the load on the PF motor and to ensure paper feeding accuracy.	See Section 5.2.1 "PF Belt Tension Adjustment" on page 137.
PF Roller Shaft Center Support Position Adjustment	To compensate the deflection amount on the PF Roller Shaft and to maintain the appropriate paper feeding amount.	See Section 5.2.3 "PF Roller Shaft Center Support Position Adjustment" on page 144.
PG Adjustment	To ensure the correct distance between the head surface and the Front Paper Guide, and to adjust the parallelism between the 0 digit side and the 130 digit side to ensure consistent print quality.	See Section 5.2.2 "PG Adjustment" on page 139.
Main Board Data Read/Write	To read the required information from EEPROM on a defective Main Board using the D4 function and to reduce the number of ancillary adjustment items when the board is replaced.	<ol style="list-style-type: none"> 1. Select this function in the Adjustment Program. 2. Read data from the defective Main Board. 3. After replacing the Main Board, write the data to the new board.
Market & Initial Settings	To write the common information to the Main Board by the different market settings, when the Main Board is replaced.	<ol style="list-style-type: none"> 1. Select and execute this function in the Adjustment Program. 2. Write the market-by-market settings and initial settings to the EEPROM. <ul style="list-style-type: none"> ■ Market-by-market settings ■ Market ID ■ CSIC Printer ID
USB ID Input	To identify the specific printer when using multiple printers of the same model, an USB ID is given to each printer.	<ol style="list-style-type: none"> 1. Select this function in the Adjustment Program and enter the serial number of the printer. 2. The correction value is saved to the specific EEPROM address of the Main Board.
Head ID Input	To reduce head manufacturing variations, which may cause individual differences in print quality, when the Printhead is replaced.	<ol style="list-style-type: none"> 1. Enter the ID of the Head QR Code Label (24 digits), which is applied to the Printhead, into the program. 2. The ID is stored in the EEPROM of the Main Board. Supplement: Read the QR code label from left to right on the top row and from top to bottom in due order.)
Head Angular Adjustment	To correct the error in the Printhead mounting position (Head angle) to make the nozzle line straight with respect to the paper feeding direction. Angular displacement is also checked for.	<ol style="list-style-type: none"> 1. Select this function in the Adjustment Program and print the adjustment pattern. 2. After checking the displacement amount of the pattern, enter the pattern number which has the smallest amount of displacement.
Bi-D Adjustment	To correct the print timing in the go and return paths in bi-directional printing.	Use the adjustment program to print out the adjustment pattern, and enter the adjustment value of the printed pattern with no black/white streaks in the block.

Table 5-1. Adjustment Items

Adjustment	Purpose	Method Outline
First Dot Position	To adjust the print starting position in the CR main scanning direction.	<ol style="list-style-type: none"> 1. Select this function in the Adjustment Program and print the adjustment pattern. 2. Select a pattern number 5mm away from each edge, and enter that number in the program. 3. The correction value is saved to the specific EEPROM address of the Main Board.
PW Sensor Adjustment	To correct the PW Sensor mounting position on a software basis to improve a paper detection error caused by the variation of the mounting position.	<ol style="list-style-type: none"> 1. Select this function in the Adjustment Program and print the adjustment pattern. 2. Select a pattern number 5mm away from each edge, and enter that number in the program. 3. The correction value is saved to the specific EEPROM address of the Main Board.
PF Deterioration Compensation Counter Reset	The deterioration amount of the PF Roller Shaft is reflected to the paper feed correction amount. Every time a sheet of paper is fed, the deterioration amount is counted on the basis of the original counter value setting. When the PF Roller Shaft or Printer Mechanism has been replaced during repair, the PF deterioration counter must be reset.	<ol style="list-style-type: none"> 1. Select and execute this function in the Adjustment Program. 2. Reset the PF deterioration counter.
Reset PF deterioration counter (write the maximum value)	The PF deterioration compensation counter can be reset only when the PF Roller Shaft is new. To reduce the ancillary work in servicing, enter the maximum value (value for which deterioration compensation is not made) if the PF Roller Shaft has not been replaced.	<ol style="list-style-type: none"> 1. Select and execute this function in the Adjustment Program. 2. Reset the PF deterioration counter.
PF Adjustment	To carry out correction when the actual paper feed amount differs greatly from the theoretical value due to paper slip, PF roller tolerances, etc. during paper feed for printing.	<ol style="list-style-type: none"> 1. Select this function in the Adjustment Program and print the adjustment pattern. 2. Select or measure the adjustment value, and write it to the specific EEPROM address on the Main Board.
PF Adjustment (Bottom Margin)	To carry out correction when the actual paper feed amount differs greatly from the theoretical value due to paper slip, exit roller tolerances, etc. while printing on the bottom of paper.	<ol style="list-style-type: none"> 1. Select this function in the Adjustment Program and print the adjustment pattern. 2. Select or measure the adjustment value, and write it to the specific EEPROM address on the Main Board.
CR Motor Drive Dispersion	To measure the manufacturing variations of the CR Motor and PS Board to make the most of the motor capabilities for motor heat generation control.	<ol style="list-style-type: none"> 1. Select/execute this function in the Adjustment Program. 2. After the execution, the variations are automatically measured and the measurement values are written to the EEPROM on the Main Board.
CR Motor Drive Dispersion (Maximum value)	CR Dispersion Measurement can be performed only when the Carriage Shaft is new. To reduce the ancillary work in servicing, enter the worst value (on which heat generation limit is easily imposed) if the Carriage Shaft has not been replaced.	<ol style="list-style-type: none"> 1. Select/execute this function in the Adjustment Program. 2. After the execution, the dispersions are automatically measured and the worst value is written to the EEPROM on the Main Board.

Table 5-2. Maintenance Functions

Function Item	Purpose	Method Outline
Ink Charge	This function is used for Printhead replacement to drain Shipping Liquid of the after-sales service part in the head flow path and simultaneously fill ink in the head flow path to make all nozzles printable and stabilize the ink in the Printhead.	<ol style="list-style-type: none"> 1. Select this function in the Adjustment Program. 2. Transfer the factory-set command (CL execution command (Initial Ink Charge) is used as the command) to the printer to make the printer perform Initial Ink Charge operation.
Refurbishment Function (Shipping Liquid replacement)	This function is used to refurbish the initially returned product. Specifically, clean the inside of the Head, and charge and replace the Shipping Liquid.	<ol style="list-style-type: none"> 1. Select this function in the Adjustment Program.
Cleaning	This function is used to execute cleaning 3 (CL3) when ink is not delivered from the Printhead properly, e.g. dot missing or skewed injection.	<ol style="list-style-type: none"> 1. Select this function in the Adjustment Program. 2. Execute CL3.
Waste Ink Counter Reset	This function is used to read and reset the Waste Ink Counters.	<ol style="list-style-type: none"> 1. In the Adjustment Program, select data read or reset from this function. Before executing this function, replace the Waste Ink Pads on both the 0 digit and 130 digit side.

5.1.2 Replacement Part-Based Adjustment Priorities

The following table indicates the replacement part-based adjustment item and priority list.

Note : Symbol explanation

- ⊙ After removing or replacing the part
- After replacing the part

NOTE : The adjustments are to be made only when the corresponding replacement parts are singly removed, and does not include any adjustments accompanied by the ancillary work.

Table 5-3. Replacement Part-Based Adjustment Item and Priority List (1)

Adjustment Item	Priority	Printhead	Main Board ¹	Main Board ²	PS Board	Waste Ink Pads	PW Sensor	CR Motor
PF Belt Tension Adjustment	1	–	–	–	–	–	–	–
PF Roller Shaft Center Support Position Adjustment	2	–	–	–	–	–	–	–
PG Adjustment	3	⊙	–	–	–	–	–	–
Main Board Data Read/Write Function	4	–	○	–	–	–	–	–
Initial Value Write	5	–	–	○	–	–	–	–
USB ID Input	6	–	–	○	–	–	–	–
Head ID Input	7	○	–	○	–	–	–	–
Head Angular Adjustment	8	⊙	–	○	–	–	–	–
Bi-D Adjustment	9 ³	⊙	–	○	–	–	–	–
First-Dot Position	10	⊙	–	○	–	–	–	–
PW Sensor Adjustment	11	⊙	–	○	–	–	⊙	–
PF Deterioration Compensation Counter Reset	12	–	–	–	–	–	–	–
PF Deterioration Compensation Counter Reset (write the maximum value) ⁴	13	–	–	○	–	–	–	–
PF Adjustment	14	–	–	○	–	–	–	–
PF Adjustment (Bottom Margin)	15	–	–	○	–	–	–	–
Waste Ink Counter Reset	16	–	–	–	–	○	–	–
CR Motor Drive Dispersion	17	–	–	○	○	–	–	○

Note 1 : When data can be read from the old board.

2 : When data cannot be read from the old board.

3 : Nozzle check patterns must be printed for confirmation.

4 : Perform this adjustment when replacing the mechanical unit with a rebuilt one whose PF Roller is not new.

Note : Symbol explanation

⊙ After removing or replacing the part

○ After replacing the part

Table 5-4. Replacement Part-Based Adjustment Item and Priority List (2)

Adjustment Item	Priority	Carriage Shaft	Carriage Unit	PF Motor	Paper EJ Frame Assy.	PF Roller Shaft	Front Paper Guide/Paper Eject Roller	ASP Mechanism Unit	ASF Assy
PF Belt Tension Adjustment	1	–	–	⊙	–	⊙	–	–	–
PF Roller Shaft Center Support Position Adjustment	2	–	–	⊙	–	⊙	–	–	–
PG Adjustment	3	⊙	⊙	–	–	⊙ ⁵	–	○	–
Reading and Writing Main Board Data	4	–	–	–	–	–	–	–	–
Initial Value Write	5	–	–	–	–	–	–	–	–
USB ID Input	6	–	–	–	–	–	–	–	–
Head ID Input	7	–	–	–	–	–	–	–	–
Head Angular Adjustment	8	○	○	–	–	–	–	○	–
Bi-D Adjustment	9 ³	○	○	–	–	–	–	○	–
First Dot Position	10	○	○	–	–	–	–	○	⊙
PW Sensor Adjustment	11	○	○	–	⊙	⊙	⊙	○	–
PF Deterioration Compensation Counter Reset	12	–	–	–	–	–	–	○	–
PF Deterioration Compensation Counter Reset (write the maximum value) ⁴	13	–	–	–	–	–	–	–	–
PF Adjustment	14	–	–	⊙	⊙	⊙	⊙	○	–
PF Adjustment (Bottom Margin)	15	–	–	⊙	⊙	⊙	⊙	○	–
Waste Ink Counter Reset	16	–	–	–	–	–	–	–	–
CR Motor Drive Dispersion	17	–	–	–	–	–	–	○	–

Note 1 : When data can be read from the old board.

2 : When data cannot be read from the old board.

3 : Nozzle check patterns must be printed for confirmation.

4 : Perform this adjustment when replacing the mechanical unit with a rebuilt one whose PF Roller is not new.

5 : This adjustment is required only when the Left Parallelism Adjust Bushing is moved.

5.1.3 Required Adjustment Tools

The following table lists the adjustment tools required for adjustment of this product.

Table 5-5. List of Tools

No.	Name	Part Code	Category	Overview
1	Adjustment Program	–	Software	This adjustment program is designed to display the required adjustment items in the appropriate order when a replacement part is selected, and provides workers with the accurate adjustment order.
2	G-26	1080614	Grease	For the Parallelism Adjust Bushing, Lower Paper Guide, Driven Release Shaft, etc.
3	G-45	1033657	Grease	For the PF Roller, Front Paper Guide, Rear Paper Guide and etc.
4	G-71	1304682	Grease	For the Carriage Unit and Carriage Shaft.
5	PG Adjustment Gauge	1276333	Gauge	A gauge exclusively used to make PG Adjustment. Check the correction value by energizing it in the same way as for Stylus Photo R1800.
6	PF Tension Measuring Tool	1231678	Measuring tool	Used to check whether or not the tension of the PF Drive Belt is within the specified value. If load is more than the specified value, the PF Motor may generate heat and burning off the coil. Reversely, if load is less than the specified value, the paper feed position may be shifted.
7	PF Roller Shaft Position Adjustment Jig	1304993	Adjusting jig	Used to check whether or not the deflection amount of the PF Roller Shaft is within the specified value. The jig is used together with the Level Block.
8	Level Block	1304994	Adjusting jig	Used to check whether or not deflection amount of the PF Roller Shaft is within the specified value. The jig is used together with the PF Roller Shaft Position Adjustment Jig.

5.2 Adjustment

This section explains the adjustments that do not use the Adjustment Program.

5.2.1 PF Belt Tension Adjustment

When either of the following parts has been removed or replaced, this adjustment must be performed to reduce load on the PF Motor and to secure paper feed accuracy.

- PF Motor
- PF Roller Shaft

The PF Tension Measuring Tool is used for this adjustment.



Figure 5-1. PF Tension Measuring Tool

5.2.1.1 PF Belt Tension Adjustment Method

CAUTION

The measurement must be carried out in a silent environment. Otherwise the microphone of the measuring tool may pick up the noise around it and the right adjustment value cannot be obtained.

1. Secure the PF Motor to the Printer Mechanism, and install the Drive Belt on the Gear of the PF Scale and the Pinion Gear of the PF Motor.
2. Press the [POWER] button. The LCD of the Measuring Tool displays No. 0 and No. 1.
3. Select the channel from among No. 0 to No. 9 by pressing the [SELECT] button. (The initial value can be selected as the channel.)
4. Press the [WEIGHT] button. The initial value will be displayed. Enter "1.2g/m" with the ten-key pad.
5. Press the [WIDTH] button. The initial value will be displayed. Enter "5.0 mm" with the ten-keypad.
6. Press the [SPAN] button. The initial value will be displayed. Enter "48mm" with the ten-keypad.

7. Bring the microphone as close as possible to the center of the Timing Belt.

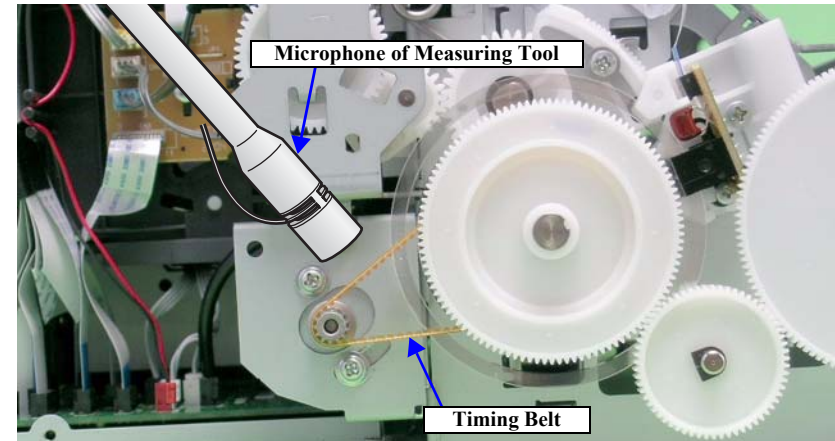

Figure 5-2. Microphone Position

CAUTION

As the Drive Belt is flipped with the tip of tweezers in the following steps, carefully choose the flipping position so that the Belt will not make contact with the microphone by reaction of flipping.

8. Press the [MEASURE] button. ("----" is displayed on the LCD screen.)
9. Put the tip of the tweezers on the Drive Belt, and flip it downward in that position. The "----" displayed on the LCD will become wave pattern during the measurement. When it has finished, the measurement result will be displayed by "N" (Newton) after the beep. This jig can pick up and measure the sounds accurately, regardless of the flipping force.
10. Repeat *Step 8* to *Step 9*, and delicately shift the variable mounting position of the PF Motor to adjust the tension until the tension falls within the specified value.



Specified Value: $11.0 \pm 2N$ (7.0 ~ 11.0N)



- Even if the Timing Belt is flipped, the LCD screen may not change at all. In this case, flip the Timing Belt again after few seconds.
- If measurement results differ greatly from each other, the sounds may not be picked up properly in one of the measurements. In which case, flip the Timing Belt again with tweezers, and record the value at which two measurement results are similar. The Measuring Tool has high reliability for displaying errors in the range from 1/100 to 5/100.

5.2.2 PG Adjustment

When any of the following parts has been removed or replaced, this adjustment must be performed to leave the specified gap between the print surface of the Printhead and paper.

- Printhead
- Carriage Unit
- Carriage Shaft
- Parallelism Adjust Bushing (Including the case when just moved its position)

In this adjustment, use the same Adjustment Gauge on the left and right sides.

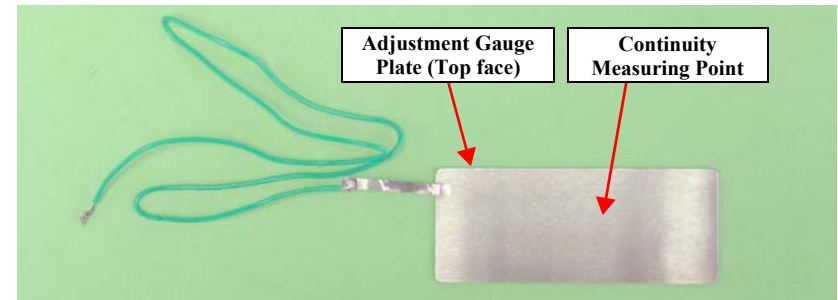

Figure 5-3. Adjustment Gauge



- Do not touch the Adjustment Gauge Plate surface with bare hands.
- If the Adjustment Gauge Plate surface is stained by ink and etc., wipe it with a soft cloth.

5.2.2.1 PG Adjustment Method

CAUTION

- Before starting PG adjustment, completely wipe off drops of ink around the Printhead. Remaining drops of ink will stick to the continuity measurement portion of the Adjustment Gauge, and generate continuity before the continuity measurement portion makes contact with the metal frame around the Printhead, interrupting accurate PG Adjustment.
- As the ink in the Printhead may stick fast and damage the Printhead during PG Adjustment, make the continuity time detected with a tester as short as possible. (Maximum 3 minutes)

CHECK POINT

As the photos used to explain these adjustments are of Stylus Photo R1800, there may be some differences in the appearance but the adjustments itself are not affected.

1. Place the printer on a level base.

CAUTION

The printer must be placed on a level and warp-free base. Any tilt or warp on the base makes the adjustment improper.

2. Connect the Tester to the printer frame and Adjustment Gauge.

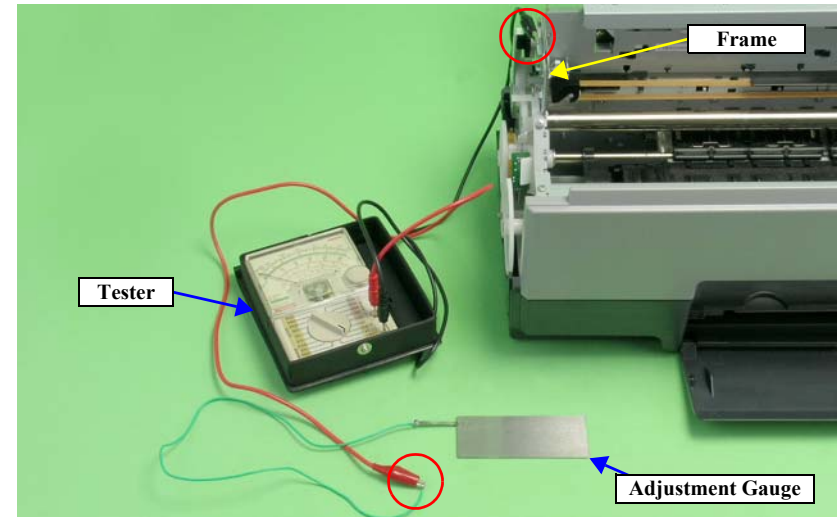

Figure 5-4. Connecting the Tester

3. Load unused Ink Cartridges of all colors into the Carriage Unit.
4. Loosen the screw that secures the Parallelism Adjust Bushing.
5. Turn the Parallelism Adjust Bushing upward to match the frame edge and the bottom of the Parallelism Adjust Bushing gear.



When the Parallelism Adjust Bushing is turned upwards, the frame rises up and PG narrows. Make sure that the frame does not come into contact with the Printhead when performing the following procedure.

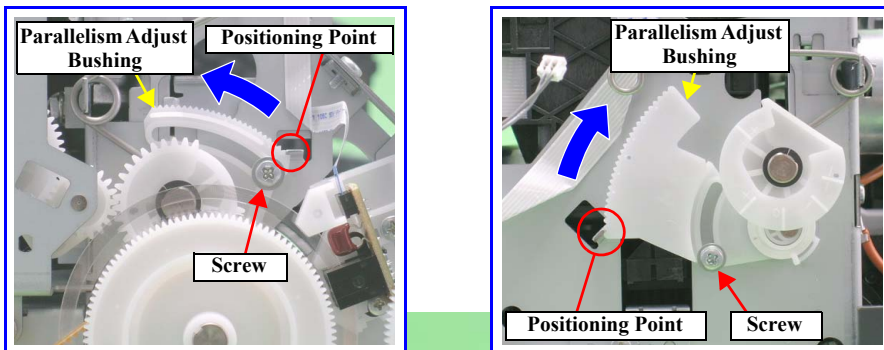

Figure 5-5. Setting the Parallelism Adjust Bushing

6. With its conductor connection portion up, set the Adjustment Gauge in the specified position (on the left side of the Front Paper Guide).
 - Setting Position
 - Rear direction: Match the rear end of the Gauge with the Driven Roller Shaft of the Upper Paper Guide.
 - Left direction: Release the left end of the Gauge from the Tab on the Front Paper Guide in [Figure 5-6](#)

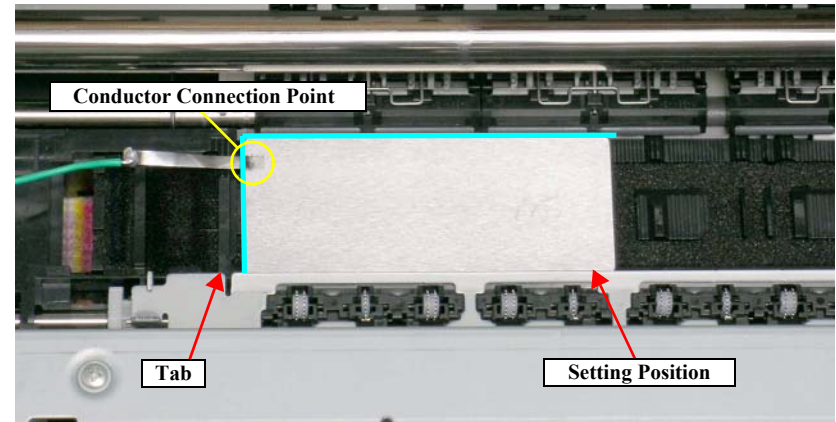

Figure 5-6. Setting the Adjustment Gauge

7. Move the Carriage Unit onto the Adjustment Gauge.
 - Moving position
 - Match the left end of the Gauge with the left end of the Carriage Unit.

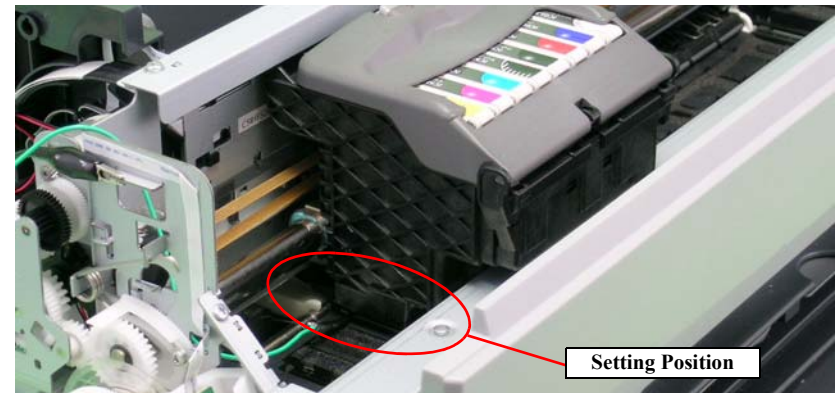

Figure 5-7. Moving the Carriage Unit

- To set the PG position to the "--" position, turn the PG Cam on the right end of the Carriage Shaft clockwise so that the point marked "--" faces down.

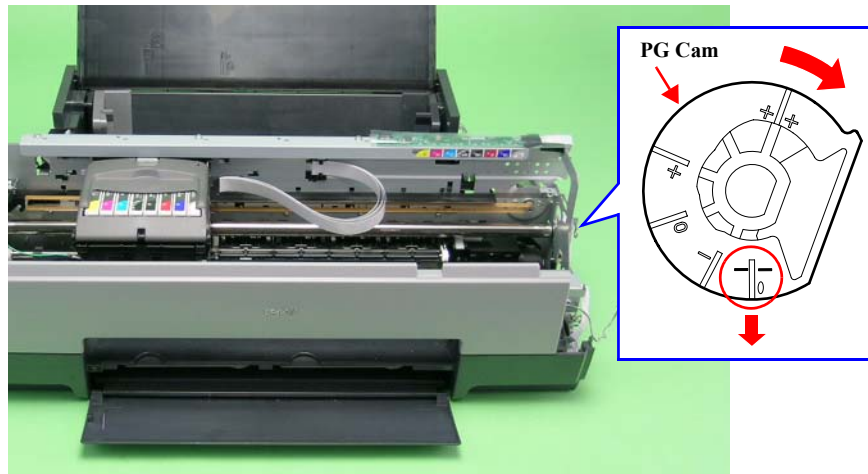

Figure 5-8. Markings of the PG Cam



■ PG Specified Value	
• PG -- (Minus Minus):	1.05mm to 1.25mm
• PG - (Minus):	1.2mm to 1.4mm
■ Adjustment Resolution:	0.06mm

- Lower the Gear of the Parallelism Adjust Bushing on the left side of the frame stepwise, and confirm continuity. Then define the position where the Gear was raised one step up from the continuity position (where continuity is lost) as the left side PG position. Move the Parallelism Adjust Bushing at least twice to confirm that the continuity position and the non-continuity position are the same.



The following figure shows the states of the Adjust Parallel Bushing on the left side of the frame and the PG. This also applies to the Adjust Parallel Bushing on the right side of the frame.)

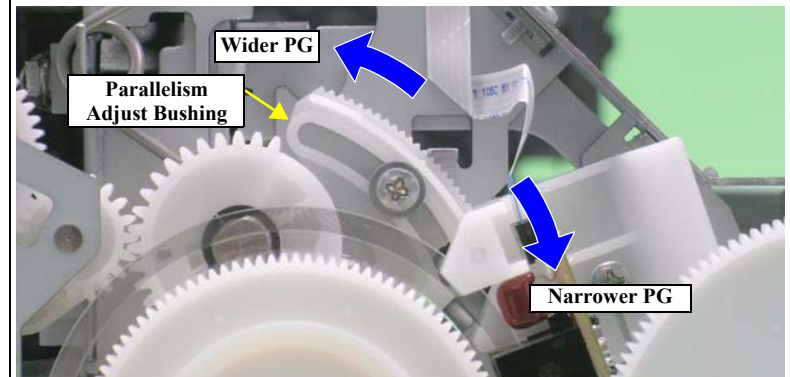

Figure 5-9. Relationship between Parallelism Adjust Bushing and PG

- To set the PG position to "0" or more, turn the PG Cams on both ends of the Carriage Shaft counterclockwise so that the point marked "0" (or "+" or "++") faces down.

11. With its conductor connection portion up, set the Adjustment Gauge in the specified position (on the right side of the Front Paper Guide).
- **Setting Position**
 Rear direction: Match the rear end of the Gauge with the Driven Roller Shaft of the Upper Paper Guide.
 Right direction: Release the right end of the Gauge from the Tab on the Front Paper Guide in *Figure 5-10*.

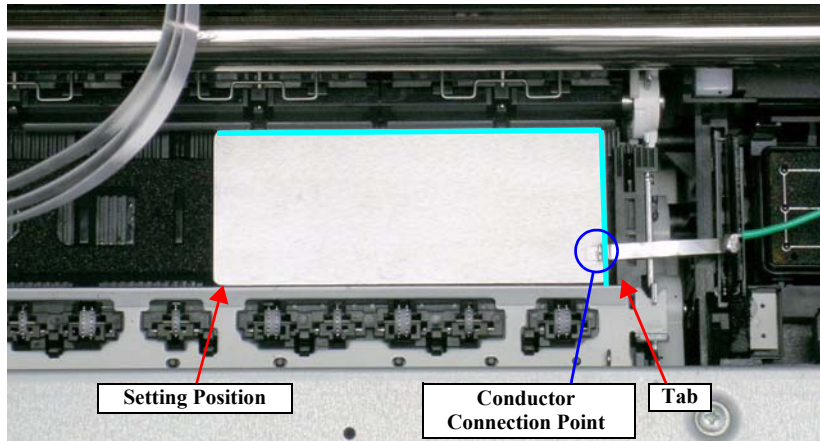

Figure 5-10. Setting the Adjustment Gauge

12. Move the Carriage Unit onto the Adjustment Gauge.
- **Moving position**
 Match the right end of the Gauge with the right end of the Carriage Unit.



Figure 5-11. Moving the Carriage Unit

13. Return the PG position to "--".
14. As in *Step 9*, move the Parallelism Adjust Bushing on the right side of the frame to set the right side PG position.
15. Set the PG position to 0 or above.
16. Set the Adjustment Gauge on the left side of the Front Paper Guide.
17. Move the Carriage Unit onto the left side Adjustment Gauge.
18. Return the PG position to "--".
19. Check continuity again at the PG position on the left side. If the PG position is not shifted, tighten the Parallelism Adjust Bushing with the screws to end the adjustment. If it is out of position, repeat the adjustment procedure from *Step 9*.

5.2.3 PF Roller Shaft Center Support Position Adjustment

This adjustment must be performed to compensate the deflection amount on the PF Roller Shaft and to maintain an appropriate paper feed amount when the following parts are removed and replaced.

- PF Motor
- PF Roller Shaft

The PF Roller Shaft Position Adjustment Jig and Level Block are used for this adjustment.



- A substitute Level Block can be used if its surface accuracy is within 50 μ .
- As the photos used to explain these adjustments are of Stylus Photo R1800, there may be some differences in the appearance but the adjustments itself are not affected.

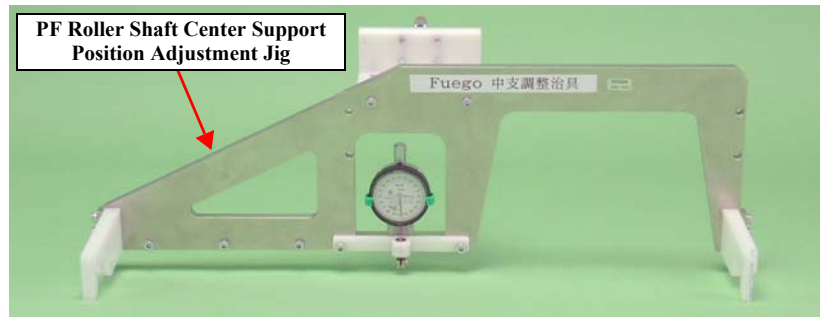

Figure 5-12. PF Roller Shaft Center Support Position Adjustment Jig and Level Block

5.2.3.1 How to Adjust the PF Roller Shaft Center Support Position

1. Before performing this adjustment, remove the following parts:
 - Lower Housing See Section 4.2.1.5 "Lower Housing and Printer Mechanism" on page 82.
 - ASF Assy See Section 4.2.4 "ASF Assy" on page 86.
 - Board Assy See Section 4.2.5.1 "Board Assy" on page 90.
 - Carriage Unit See Section 4.2.6.5 "Carriage Shaft and Carriage Unit" on page 98.
2. Place the printer on a level base.



The printer must be placed on a level and warp-free base. Any tilt or warp on the base makes the adjustment improper.

3. Set the PF Roller Shaft Position Adjustment Jig in place on the Level Block, and perform zero adjustment.
 - Long hand position: Turn the dial of the jig to adjust the long hand on "0" with the jig set in place on the Level Block.
 - Short hand position: Check its value.

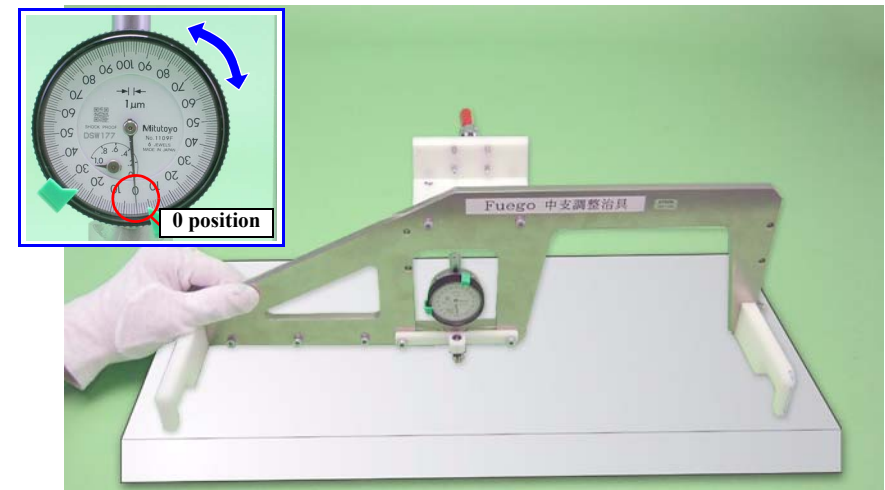

Figure 5-13. Setting the PF Roller Shaft Position Adjustment Jig

- Loosen the screws that secure the Center Support Bushing Cam and the Center Support Bush.

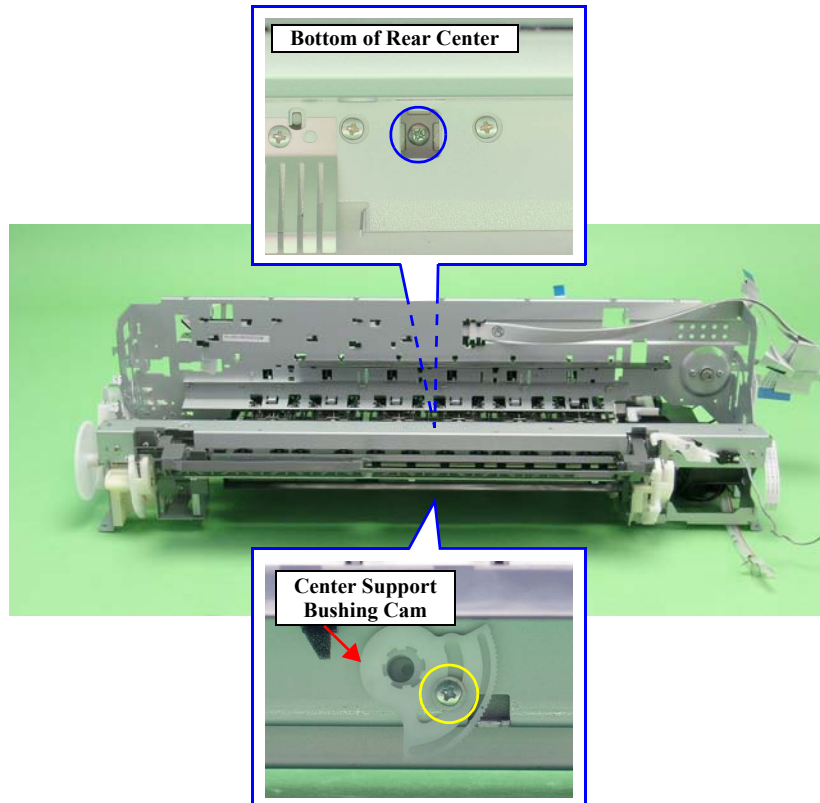

Figure 5-14. Center Support Bushing Cam and the Screw



Check if any dirt is on the PF Roller Shaft. If there is, remove it before performing the following procedure.

- Set the jig in place on the PF Roller Shaft as shown in the figure below.
 - Left side: Inside of PF Roller left end (E-ring)
 - Right side: Gap between PF Roller right end (Right Bushing 8) and left end of Upper Paper Guide
 - Center: Gap between the 2nd Upper Paper Guide and 3rd one from the left

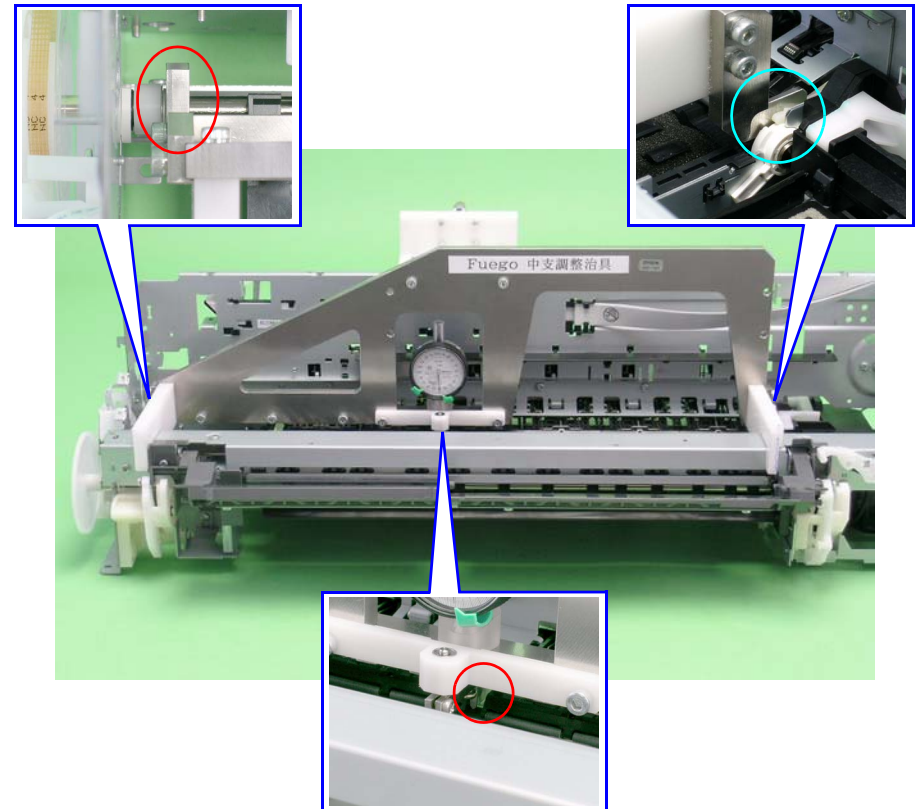

Figure 5-15. Setting the PF Roller Shaft Position Adjustment Jig

6. Turn the Center Support Bushing Cam to make the long hand position $+30\mu$ from the "0" adjustment position.



- Specified Value: $30 \pm 50\mu$
- Adjustment Resolution: 50μ



- $+30\mu$ must be set to compensate for the thickness of the coating on the PF Roller Shaft.
- Make sure that the position of the short hand is the same as at "0" adjustment.



The figure below shows the positional relationship between the Center Support Bushing Cam and the Dial Gage.

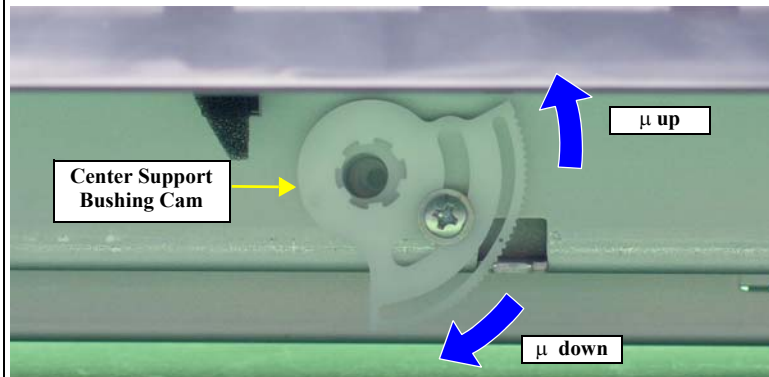

Figure 5-16. Positional Relationship between Center Support Bushing Cam and the Dial Gage

7. Tighten the Center Support Bushing Cam and the Center Support Bushing with the screws.



Check the adjustment value again as it deviates slightly when the screw is tightened.

The following page shows print samples when the adjustment value of the PF Roller Shaft Center Support Positions are within and out of the specified value range.



Figure 5-17. Out of the Specified Value Range

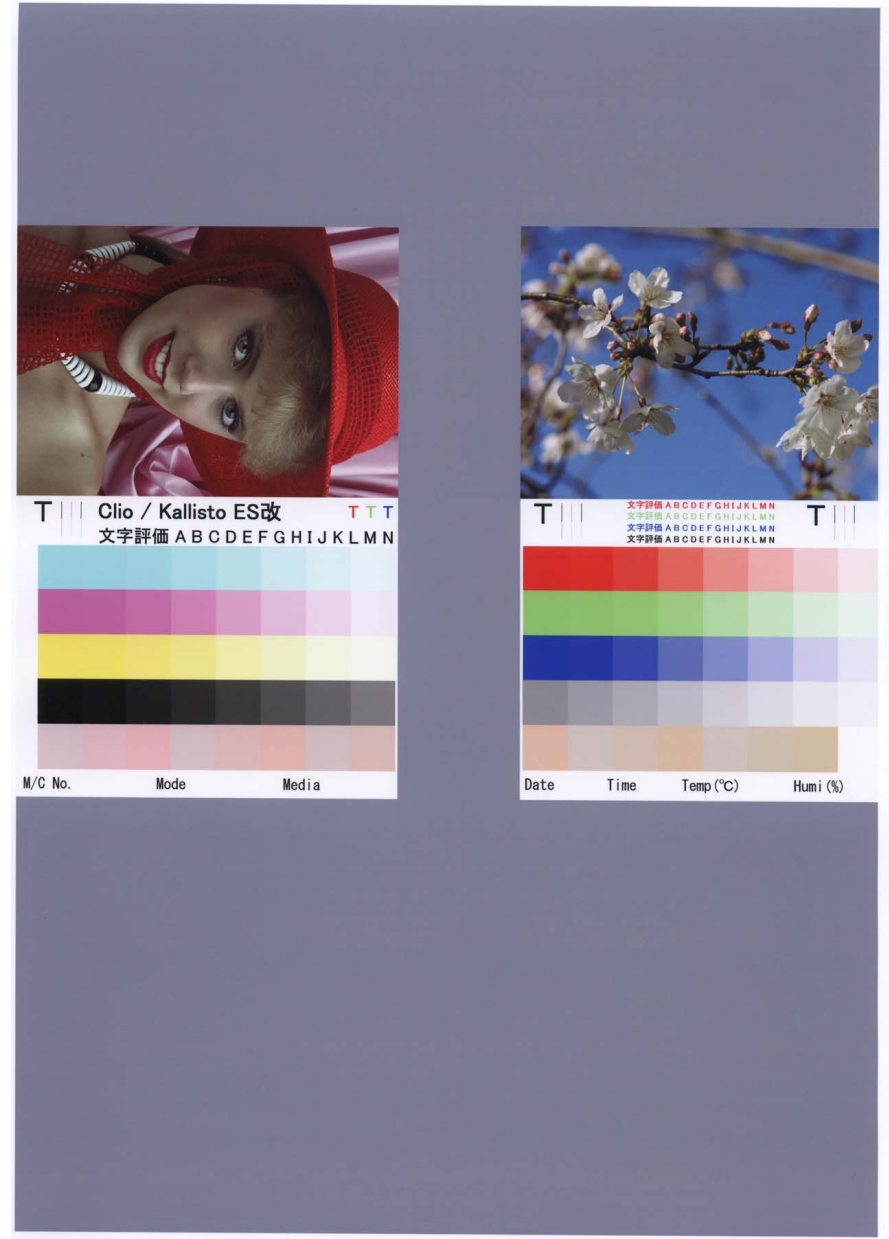

Figure 5-18. Within the Specified Value Range

CHAPTER

6

MAINTENANCE

6.1 Overview

This section provides information to maintain the printer in its optimum condition.

6.1.1 ROM Replacement

This printer may require the ROM to be replaced when the program is changed or added. In such cases, use the special tool (ROM puller: 2035659 (#F749)) to replace the ROM. The position of the ROM is shown in the figure below.

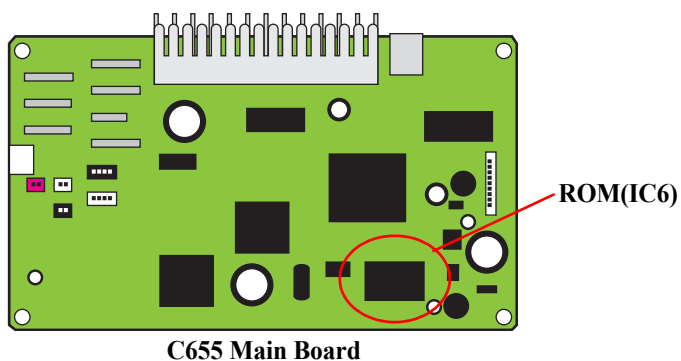

Figure 6-1. ROM Location

6.1.2 Cleaning

This printer has no mechanical components which require regular cleaning. Therefore, when returning the printer to the user, check the following parts and perform appropriate cleaning if stain is noticeable.

CAUTION

- Never use chemical solvents, such as thinner, benzene, and acetone, to clean the exterior parts of the printer like the housing. These chemicals may degrade or deteriorate the quality of this product.
- Be careful not to damage any components when you clean inside the printer.
- Do not scratch the surface of the PF Roller assembly. Use a soft brush to wipe off dust.
- Use a soft cloth moistened with dilute alcohol to remove ink stain.
- Do not make regular use of the supplied cleaning sheet for normal use. It may damage the coated surface of the PF Roller. It is okay if the adhesive surface of the cleaning sheet is set to the ASF LD Roller side and used to clean the ASF LD Roller surface.
- When using compressed air products; such as air duster, for cleaning during repair and maintenance, the use of such products containing flammable gas is prohibited.

- Housing
Use a clean soft cloth moistened with water and wipe off any dirt. If the Housings are stained with ink, use a cloth moistened with neutral detergent to wipe it off.

- Inside the printer
Use a vacuum cleaner to remove any paper dust.

6.1.3 Service Maintenance

If print irregularity (missing dot, white line, etc.) has occurred or the printer indicates “Maintenance Error”, take the following actions to clear the error.

6.1.3.1 Head Cleaning

The printer has a built-in head cleaning function, which is activated by operating the control panel. The procedure is given below.

1. Confirm that the printer is in a stand-by state.
Check that the Power LED is not flashing.
2. Hold down the Ink button on the control panel for more than 3 seconds.
The Power LED flashes during the cleaning sequence.



For Head Cleaning, it is recommended to run the nozzle check and the cleaning alternately to minimize ink consumption.

6.1.3.2 Maintenance Request

Ink is used for printing and Head Cleaning. Waste ink is drained into the Waste Ink Pads via the Cap Unit, and its amount is stored into the EEPROM's Protection Counters (Waste Ink Counter) A and B (located near the home position or the opposite side). When the preset value is reached, the Waste Ink Counters detect that the Waste Ink Pads have reached the absorption limit. The printer displays “Maintenance Request” to request the Waste Ink Pads to be replaced.

- Protection Counter A+B Limit
 - Up to 17455
- Timing for Replacing the Waste Ink Pads
 - When the Protection Counter reaches the value shown above, a Maintenance Request is indicated, and the printer disables all switches except the Power button.
 - Since the Protection Counter value can be confirmed in the adjustment program, be sure to check the value when servicing regardless of whether the service is related to the Waste Ink Pad or not. If the Protection Counter value of that printer is close to its limit, inform the user, and replace the Waste Ink Pads and reset the Counters with the user's permission. (If the Waste Ink Pads are not replaced at that time, it is expected that the printer will be returned for repair in the near future due to a Maintenance Request error.)
 - Under specific conditions, the limit level of the counter is preset to 25000 pages for black ink and to 10000 pages for color ink. We assume that the limit level will be reached in about 5 years at normal usage.
- Replacement Procedure
Replacement of Waste Ink Pads in Disassembly and Assembly
(Refer to 4.2.2 "Waste Ink Pad" on page 84.)
- After the Replacement
Reset the Protection Counter (Refer to Chapter 5 “ADJUSTMENT”)

6.1.4 Lubrication

The lubrication used for the components of the printer has been decided on bases of evaluation carried out by Epson. The specified type of grease and the amount, and places of lubrication given in this section should be strictly observed.



- Never use oil or grease other than those specified in this manual. Use of different types of oil or grease may damage the components or affect the printer functions.
- Never apply a larger amount of oil or grease than specified in this manual.

Table 6-1. Grease Applied to the Stylus Photo 1390/1400/1410

Type	Name	EPSON CODE	Supplier
Grease	G-26	1080614	EPSON
Grease	G-45	1033657	EPSON
Grease	G-71	1304682	EPSON

	<Lubrication Point> Left and Right Adjust Parallel Bushings (outer circumference)
	<Lubrication Type> G-26
	<Lubrication Amount> φ1mm x 2mm
	<Remarks> <ul style="list-style-type: none"> Apply with a syringe. (Pin Head: φ1mm) After lubrication, install and turn the PG Cam Bush to spread the grease evenly.

Figure 6-2. Lubrication (1)

	<Lubrication Point> Contact points of the CR Scale Mounting Plate (Left/Right) and the Main Frame
	<Lubrication Type> G-26
	<Lubrication Amount> Apply evenly.
	<Remarks> Apply with a brush.

Figure 6-3. Lubrication (2)

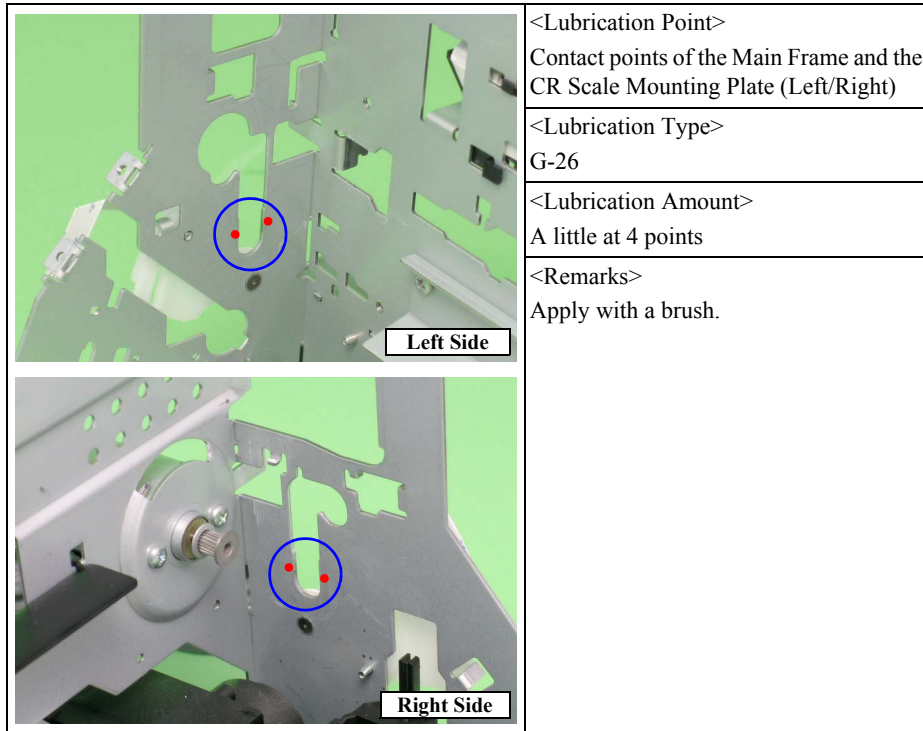

Figure 6-4. Lubrication (3)

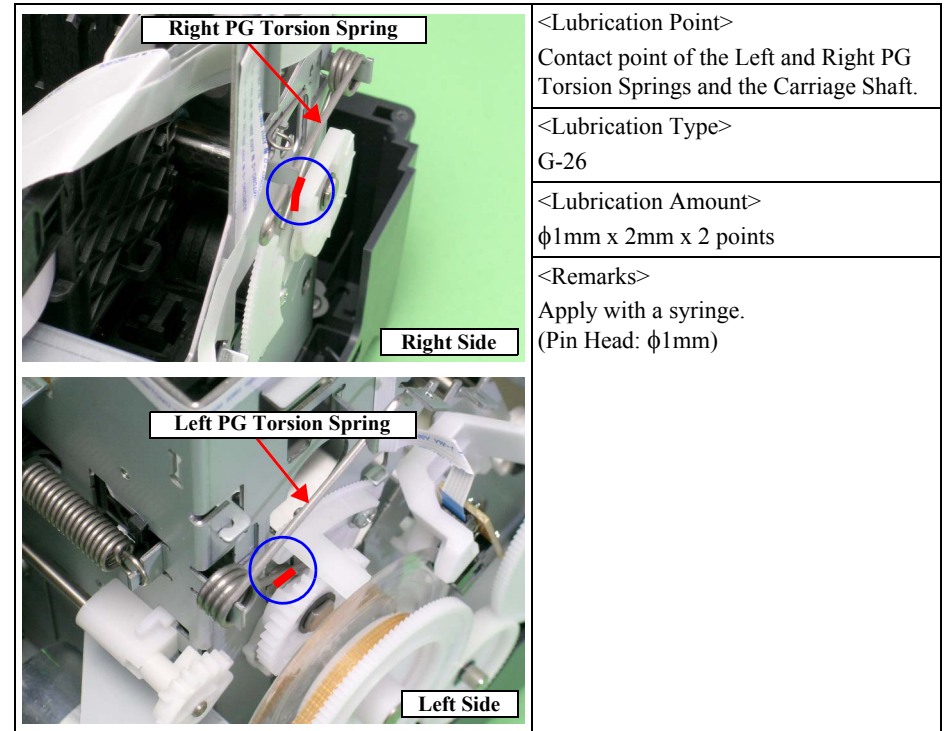

Figure 6-6. Lubrication (5)

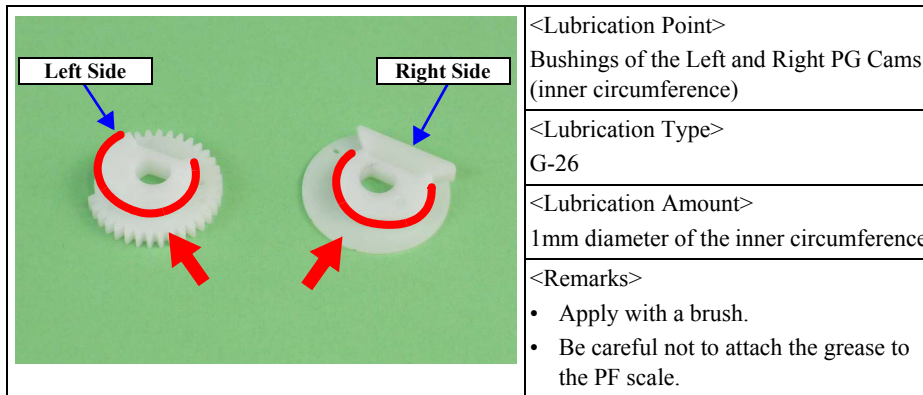

Figure 6-5. Lubrication (4)

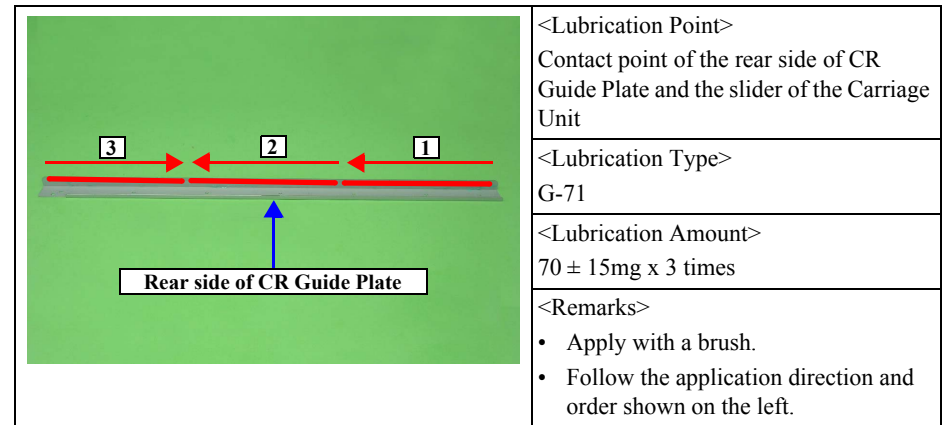

Figure 6-7. Lubrication (6)

	<Lubrication Point> The Driven Pulley Holder
	<Lubrication Type> G-26
	<Lubrication Amount> φ1mm x 2mm x 4 points
	<Remarks> Apply with a syringe. (Pin Head: φ1mm)

Figure 6-8. Lubrication (7)

	<Lubrication Point> Contact points of the Driven Release FLAG and the Upper Paper Guide
	<Lubrication Type> G-26
	<Lubrication Amount> φ2mm x 6 points
	<Remarks> Apply with a syringe. (Pin Head: φ1mm)

Figure 6-9. Lubrication (8)

	<Lubrication Point> Contact points of the EJ Grounding Spring and Front/Rear Paper EJ Rollers
	<Lubrication Type> G-45
	<Lubrication Amount> φ1mm x 2mm x 2 points
	<Remarks> Apply with a syringe. (Pin Head: φ1mm)

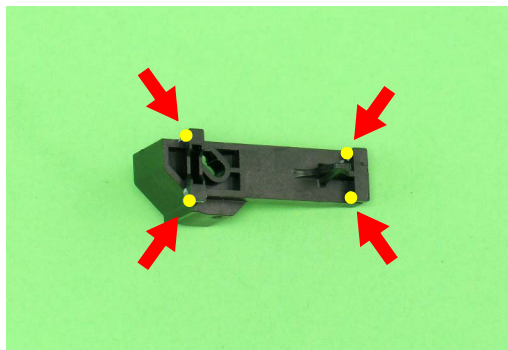
Figure 6-10. Lubrication (9)

	<Lubrication Point> The bushings of the Front Paper Guide
	<Lubrication Type> G-45
	<Lubrication Amount> 1. Apply evenly. 2. φ1mm x 2mm
	<Remarks> Apply with a brush.

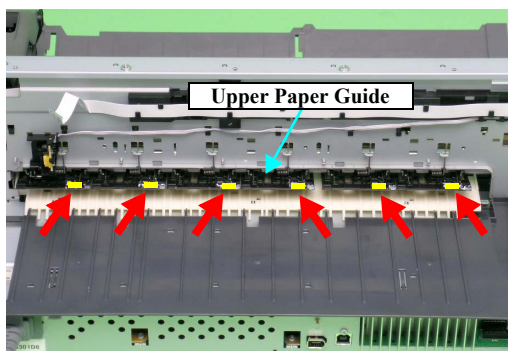
Figure 6-11. Lubrication (10)

	<Lubrication Point> 1. Left side of the PF Roller Shaft (Left of the E-Ring) 2. Mounting location of the Bushing 8
	<Lubrication Type> G-45
	<Lubrication Amount> 1. Approx. φ1mm x 5mm 2. All around the Shaft
	<Remarks> 1. Apply with a syringe. 2. Apply with a brush.

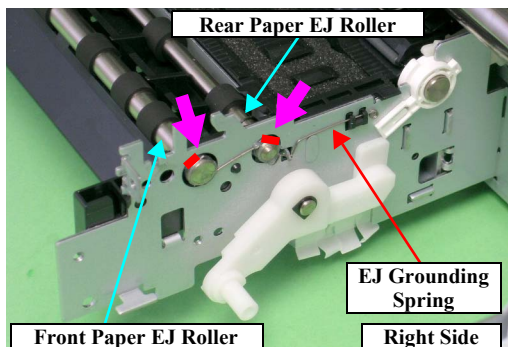
Figure 6-12. Lubrication (11)

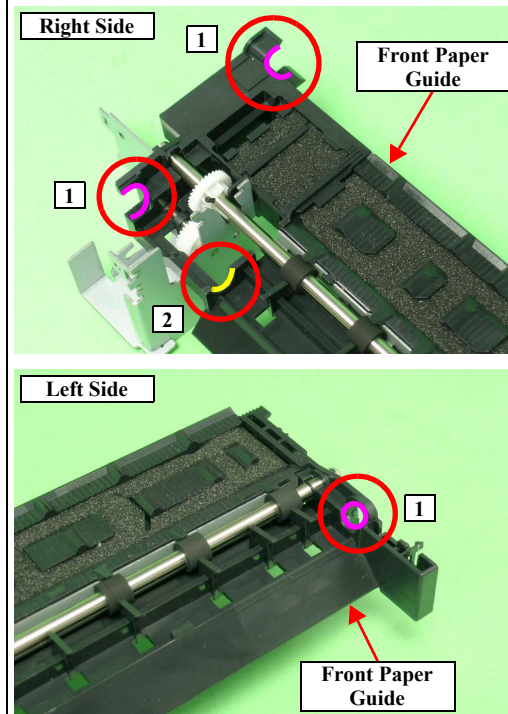

<Lubrication Point>
1. Contact points of the Rear Paper Guide and the PF Roller
2. Contact point of the PF Grounding Spring and the PF Roller
<Lubrication Type>
G-45
<Lubrication Amount>
1. Apply evenly.
2. $\phi 1\text{mm} \times 2\text{mm}$
<Remarks>
1. Apply with a brush.
2. Apply with a syringe. (Pin Head: $\phi 1\text{mm}$)

Figure 6-13. Lubrication (12)

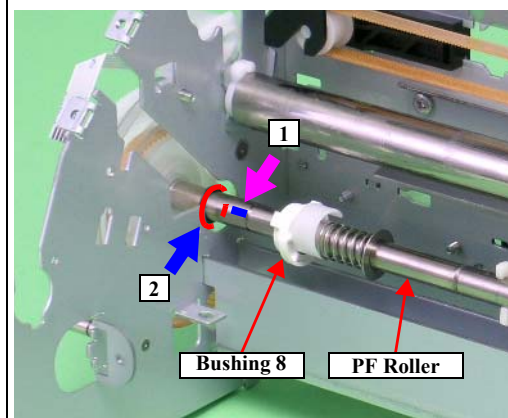
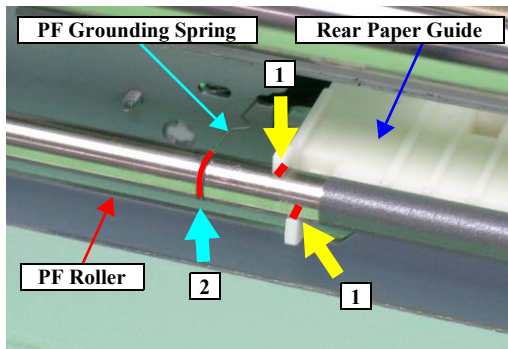
6.1.4.1 Lubrication of Carriage Shaft

1. Fit the Carriage Unit to the Carriage Shaft, and move it to the center of the Shaft.



In the following step, do not bring the needle of a syringe into contact with the Carriage Shaft.

2. Using a syringe, lubricate the 2 holes at both ends of the Carriage Unit rear side with the grease.

Lubrication Type	Lubrication Amount
G-71	140 ± 10mg x 2 points

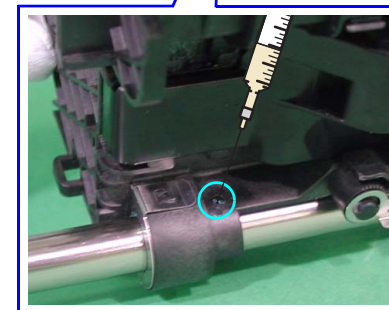
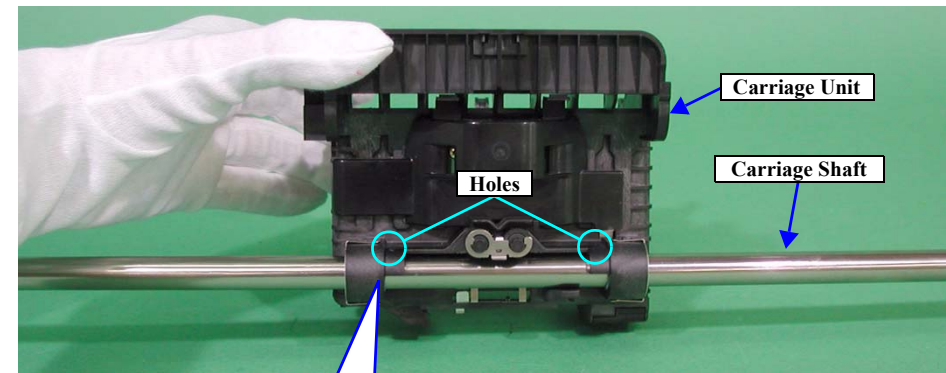

Figure 6-14. Carriage Shaft lubrication (1)

3. Hold the Carriage Unit, and turn the Carriage Shaft clockwise and counterclockwise, while moving the Carriage Unit sideways to spread the grease evenly.

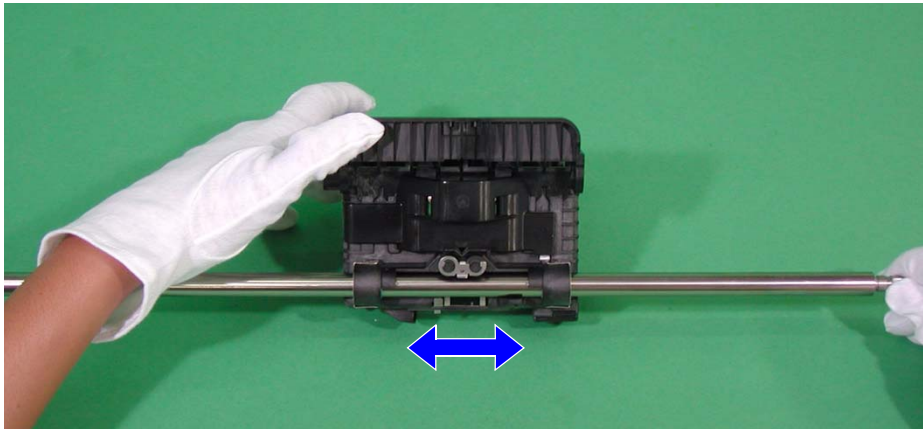

Figure 6-15. Carriage Shaft lubrication (2)

4. Move the Carriage Unit to the right end of the Carriage Shaft viewing the Unit from the rear, and lubricate the grease using a syringe at the point shown in *Figure 6-16*.

Lubrication Type	Lubrication Amount
G-71	140 ± 10mg

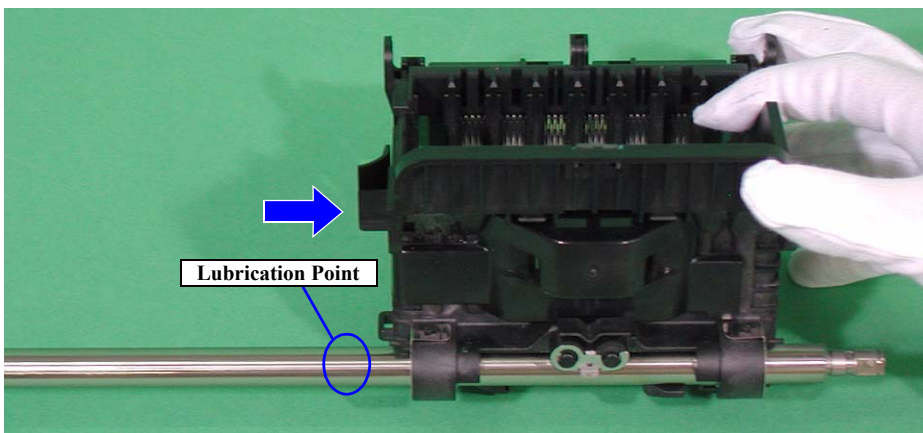

Figure 6-16. Carriage Shaft lubrication (3)

5. Hold the Carriage Unit, and while turning the Carriage Shaft, move the Carriage Unit to the left end of the Carriage Shaft to lubricate the grease evenly.
6. Lubricate the grease using a syringe at the point shown in *Figure 6-17*.

Lubrication Type	Lubrication Amount
G-71	140 ± 10mg

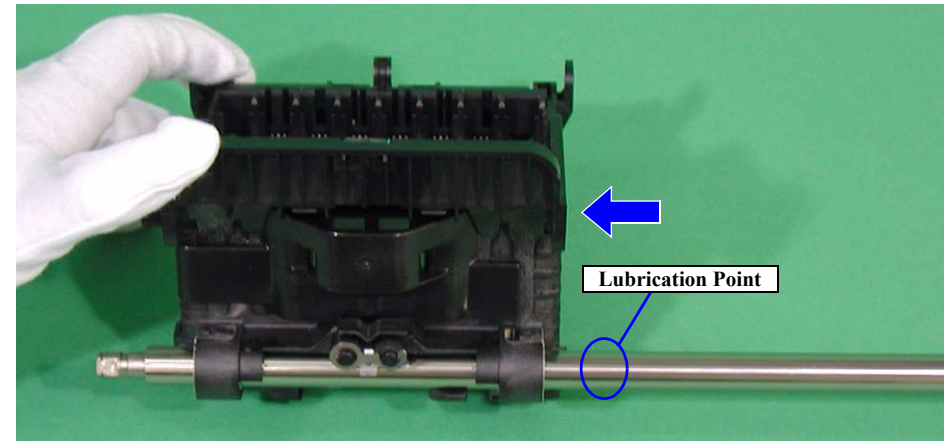

Figure 6-17. Carriage Shaft lubrication (4)

7. Hold the Carriage Unit, and while turning the Carriage Shaft, move the Carriage Unit to the right end of the Carriage Shaft to lubricate the grease evenly.

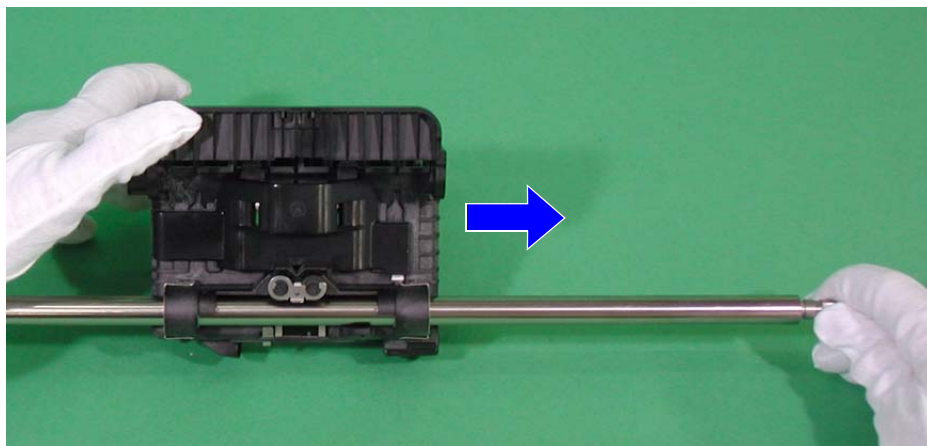

Figure 6-18. Lubricating the Carriage Shaft (5)

8. Repeat *Step 4 ~ 7*.

CHAPTER

7

APPENDIX

7.1 Connector Summary

This section shows connections between main components of Stylus Photo 1390/1400/1410.

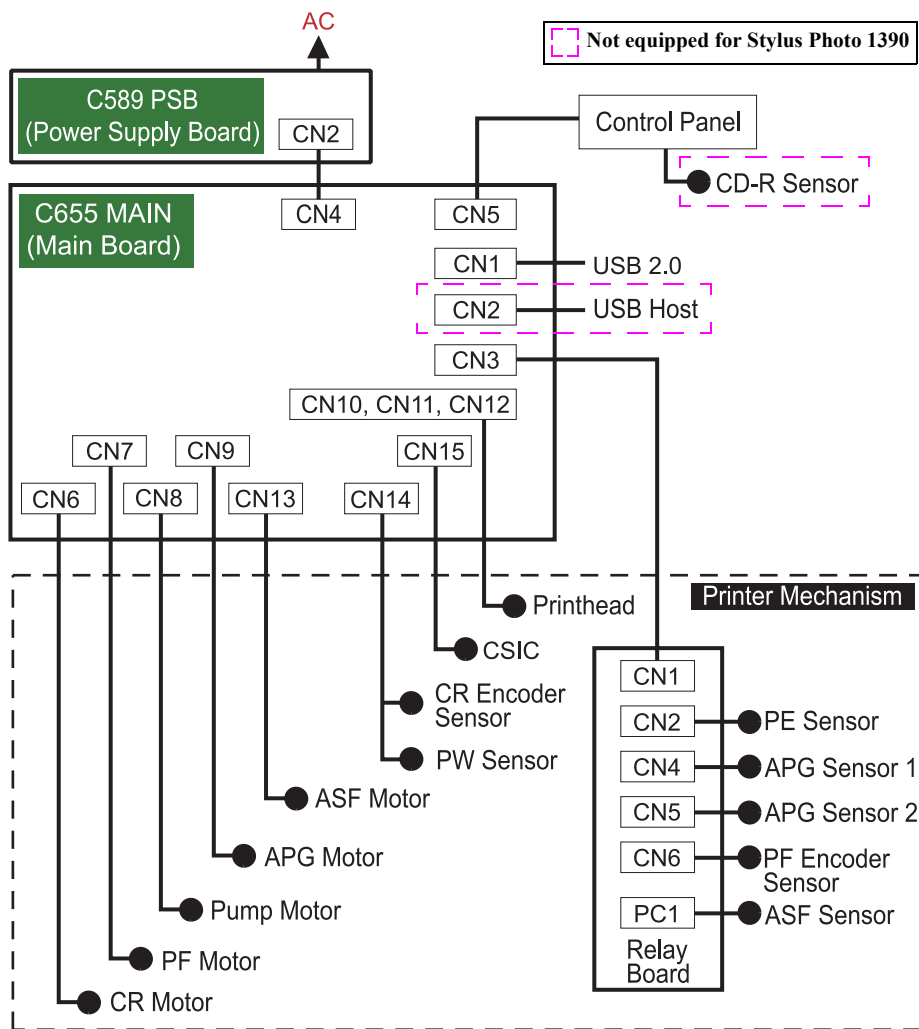

Figure 7-1. Connections of Main Components

7.1.1 Connectors and Pin Layouts

See the following tables for the connector summary of the C655 MAIN Board and each connector's pin alignment.

Table 7-1. Connector Summary

Connector	Function	Reference
CN1	USB Device	Table 7-2
CN2	USB Host*	Table 7-3
CN3	Relay Board	Table 7-4
CN4	Power Supply	Table 7-5
CN5	Panel	Table 7-6
CN6	CR Motor	Table 7-7
CN7	PF Motor	Table 7-8
CN8	Pump Motor	Table 7-9
CN9	APG Motor	Table 7-10
CN10	Printhead	Table 7-11
CN11	Printhead	Table 7-12
CN12	Printhead	Table 7-13
CN13	ASF Motor	Table 7-14
CN14	Sensors	Table 7-15
CN15	CSIC	Table 7-15

Note *: Stylus Photo 1390 does not have the connector.

Table 7-2. Connector CN1: USB Device

Pin	Signal	I/O	Function
1	VBUS_IN	–	USB VBUS input
2	D-	I/O	USB D- signal
3	D+	I/O	USB+ signal
4	GND	–	Ground

Table 7-3. Connector CN2: USB Host*

Pin	Signal	I/O	Function
1	VCC	–	USB VBUS output
2	D-	I/O	USB D- signal
3	D+	I/O	USB+ signal
4	GND	–	Ground

Note *: Stylus Photo 1390 does not have the connector.

Table 7-4. Connector CN3: Relay Board

Pin	Signal	I/O	Function
1	+3.3V_SN	–	+3.3V power supply for energy saving feature
2	+3.3V	–	+3.3V power supply
3	ASF	I	ASF sensor signal
4	GND	–	Ground
5	PF_ENCB	I	PF encoder input signal (phase B)
6	GND	–	Ground
7	PF_ENCA	I	PF encoder input signal (phase A)
8	GND	–	Ground
9	PE	I	PE sensor signal
10	APG1	I	APG1 sensor signal
11	APG2	I	APG2 sensor signal

Table 7-5. Connector CN4: Power Supply

Pin	Signal	I/O	Function
1	+42V	–	+42V
2	+42V	–	+42V
3	GND	–	Ground
4	+5V_OVP	–	Overvoltage detection
5	PSC	I	Power supply control
6	GND	–	Ground
7	+3.3V	–	+3.3V
8	GND	–	Ground
9	ESAVE	–	Energy saving

Table 7-6. Connector CN5: Panel

Pin	Signal	I/O	Function
1	SW3	I	SENSE2
2	CD-R	I	CDR signal*
3	SW2	I	SCNHP
4	SW1	I	PNLLEDEN
5	LED1	O	Panel LED output signal (1)
6	LED2	O	Panel LED output signal (2)
7	GND	–	Ground
8	+3.3V	–	+3.3V
9	LED0	O	Panel LED output signal (0)
10	SW0	I	Input signal (0) for panel switch
11	PSC	–	Power switch output signal

Note *: Not assigned for the Stylus Photo 1390.

Table 7-7. Connector CN6: CR Motor

Pin	Signal	I/O	Function
1	CR-A	O	CR motor drive signal (phase A)
2	CR-B	O	CR motor drive signal (phase B)

Table 7-8. Connector CN7: PF Motor

Pin	Signal	I/O	Function
1	PF-A	O	PF motor drive signal (phase A)
2	PF-B	O	PF motor drive signal (phase B)

Table 7-9. Connector CN8: Pump Motor

Pin	Signal	I/O	Function
1	PUMP-A	O	Pump motor drive signal (phase A)
2	PUMP-B	O	Pump motor drive signal (phase B)
3	PUMP-/A	O	Pump motor drive signal (phase /A)
4	PUMP-/B	O	Pump motor drive signal (phase /B)

Table 7-10. Connector CN9: APG Motor

Pin	Signal	I/O	Function
1	APG-A	O	APG motor drive signal (phase A)
2	APG-B	O	APG motor drive signal (phase B)

Table 7-11. Connector CN10: Printhead

Pin	Signal	I/O	Function
1	TH	I	Head temperature signal (AN1)
2	SI3	O	HSO3
3	GND	–	Ground
4	SI2	O	HSO2
5	GND	–	Ground
6	SI1	O	HSO1
7	GND	–	Ground
8	GND2_3	–	Ground
9	COMB_2	–	Trapezoid wave
10	GND2_1	–	Ground
11	COMA_3	–	Trapezoid wave
12	GND2_2	–	Ground
13	COMA_1	–	Trapezoid wave

Table 7-12. Connector CN11: Printhead

Pin	Signal	I/O	Function
1	GND2_1	–	Ground
2	COMA_2	–	Trapezoid wave
3	GND2_3	–	Ground
4	COMB_1	–	Trapezoid wave
5	GND2_2	–	Ground
6	COMB_3	–	Trapezoid wave
7	GND	–	Ground
8	VDD2	–	+3.3V
9	CH_B	O	EXHCH (head CH_B)
10	GND	–	Ground
11	SCK	O	Serial clock signal
12	GND	–	Ground
13	XHOT	I	Head temperature signal

Table 7-13. Connector CN12: Printhead

Pin	Signal	I/O	Function
1	GND	–	Ground
2	LAT	O	HLAT (head latch)
3	GND	–	Ground
4	NCHG	O	NCHG (head NCHG)
5	GND	–	Ground
6	CH_A	O	HCH (head CH_A)
7	VDD	–	+3.3V
8	GND	–	Ground
9	VHV	–	+42V power supply for printhead

Table 7-14. Connector CN13: ASF Motor

Pin	Signal	I/O	Function
1	ASF-A	O	ASF motor drive signal (phase A)
2	ASF-B	O	ASF motor drive signal (phase B)
3	ASF-/A	O	ASF motor drive signal (phase /A)
4	ASF-/B	O	ASF motor drive signal (phase /B)

Table 7-15. Connector CN14: Sensors

Pin	Signal	I/O	Function
1	GND	–	Ground
2	GND	–	Ground
3	GND	–	Ground
4	GND	–	Ground
5	GND	–	Ground
6	GND	–	Ground
7	CR-ENCA	I	CR encoder A signal
8	GND	–	Ground
9	CR-ENCB	I	CR encoder B signal
10	EVDD	–	Power supply for CR encoder (supports energy saving feature)
11	LEDON	–	Paper width sensor LED power supply
12	GND	–	Ground
13	PW	I	Paper width sensor signal (analog)

Table 7-16. Connector CN15: CSIC

Pin	Signal	I/O	Function
1	CSDA	I/O	CDIO (CSIC sent/received data)
2	COI	I	CO (cartridge detection)
3	CCLK	I/O	CCLK (CSIC sent/received clock)
4	GND	–	Ground
5	CRST	O	CXRST (CSIC reset)
6	CVDD	O	Power supply for CSIC
7	CH_A	O	HCH (head CH)
8	ENABLE	I	CENB
9	VDD	–	+3.3V
10	GND	–	Ground
11	COMA_1	–	Trapezoid wave
12	GND	–	Ground
13	VHV	–	+42V power supply for printhead

7.2 Exploded Diagrams and Parts List

This manual does not include the exploded diagrams and the parts list.
For information on the diagrams and the parts list, see the Service Parts Information.

7.3 Electrical Circuit Diagrams

The electrical circuit diagrams of Stylus Photo 1390/1400/1410 are shown on the pages that follow.

- C655 MAIN 1
- C655 MAIN 2
- C589 PSB
- C589 PSE
- C589 PANEL
- C653 HEAD

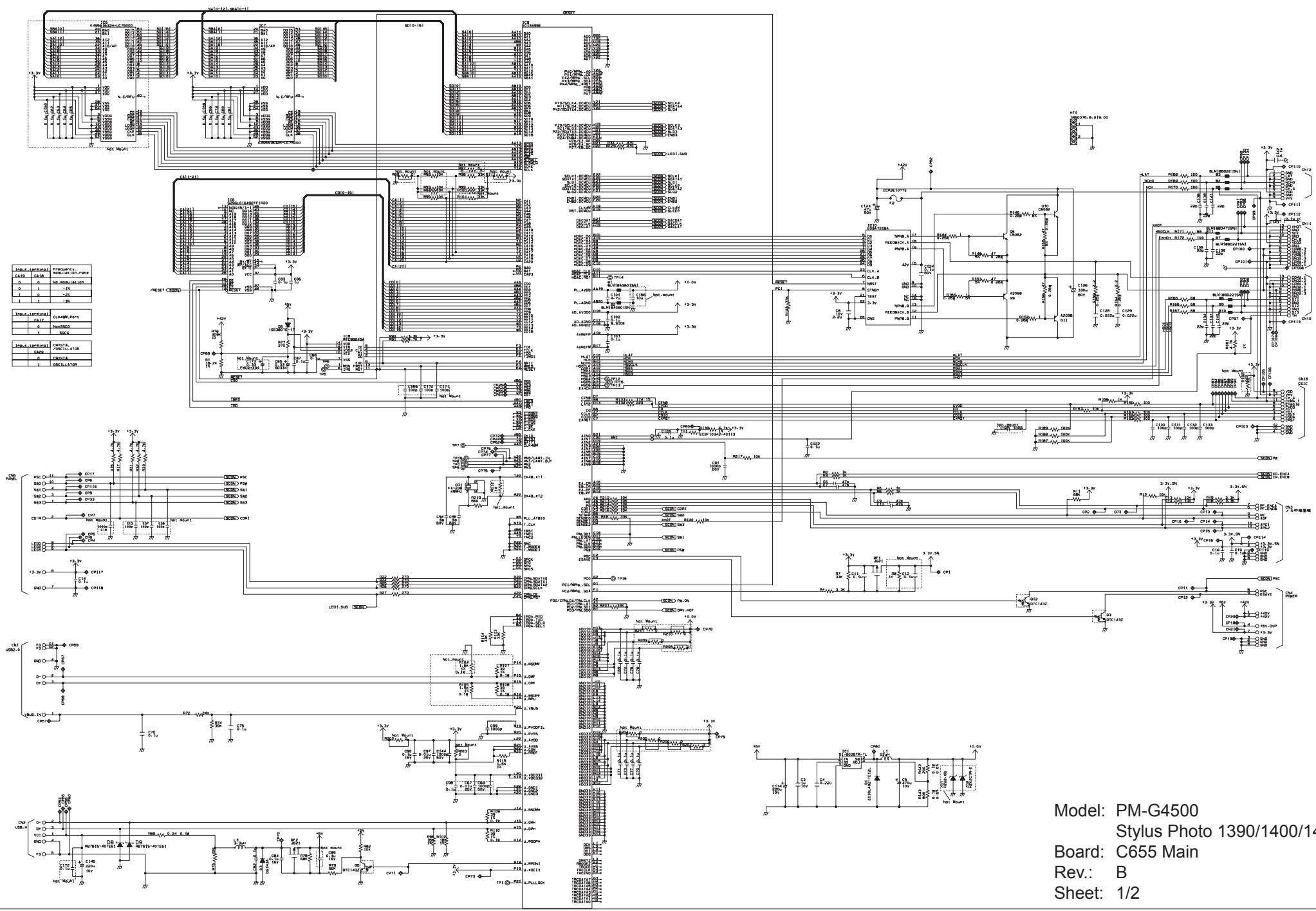

Model: PM-G4500
 Stylus Photo 1390/1400/1410
 Board: C655 Main
 Rev.: B
 Sheet: 1/2

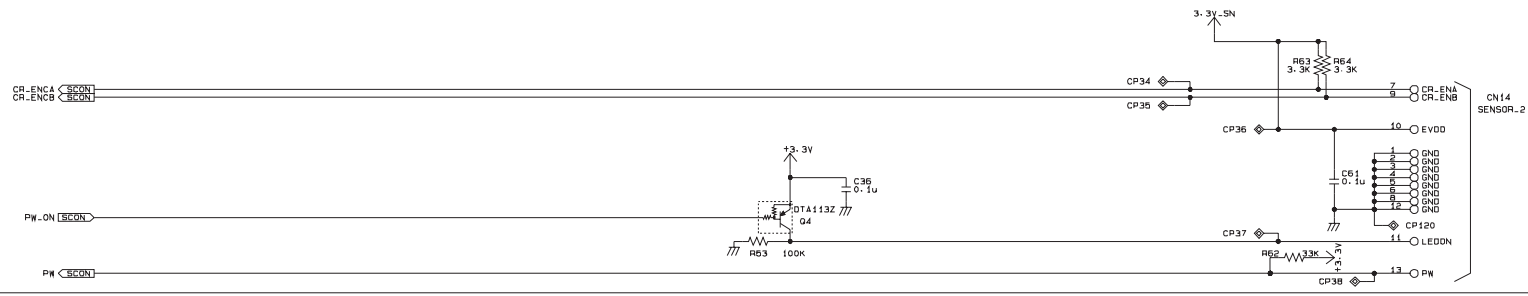
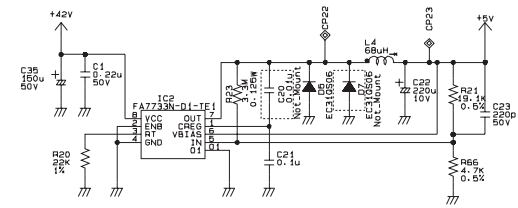
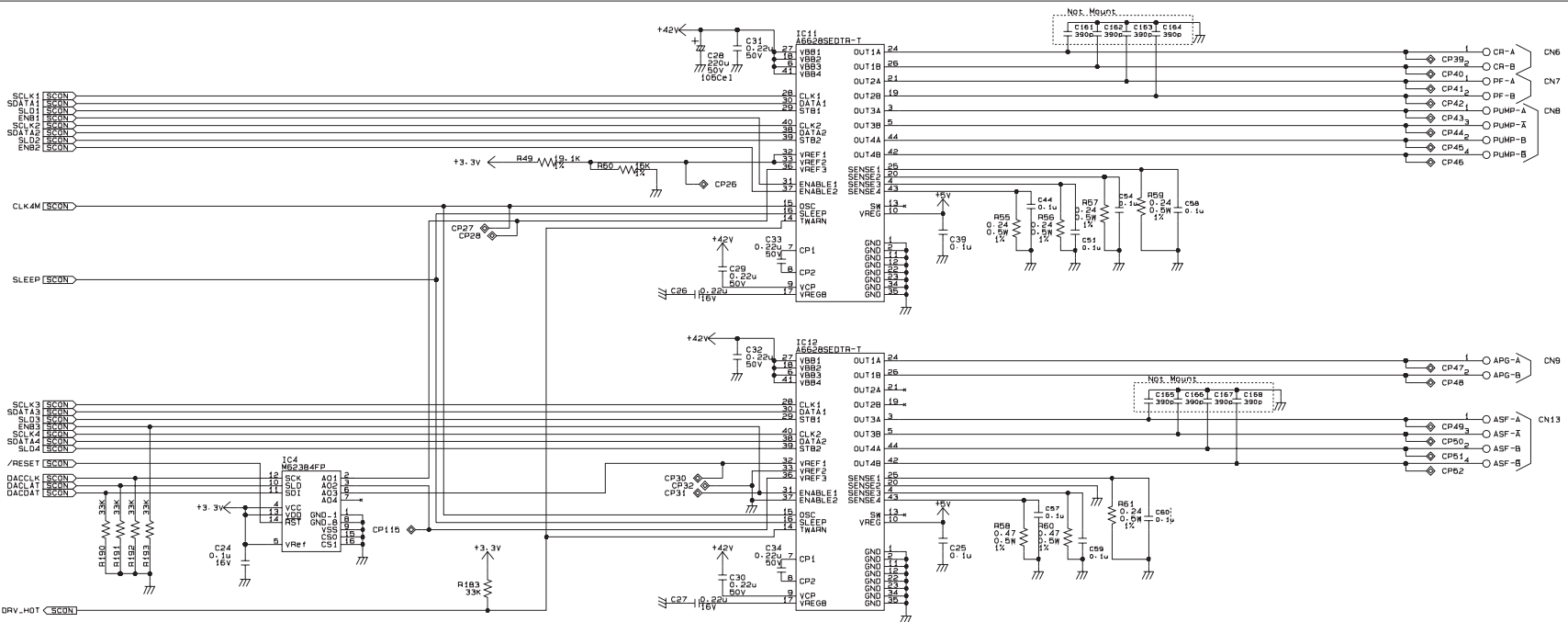

Model: PM-G4500
 Stylus Photo 1390/1400/1410
 Board: C655 Main
 Rev.: A
 Sheet: 2/2

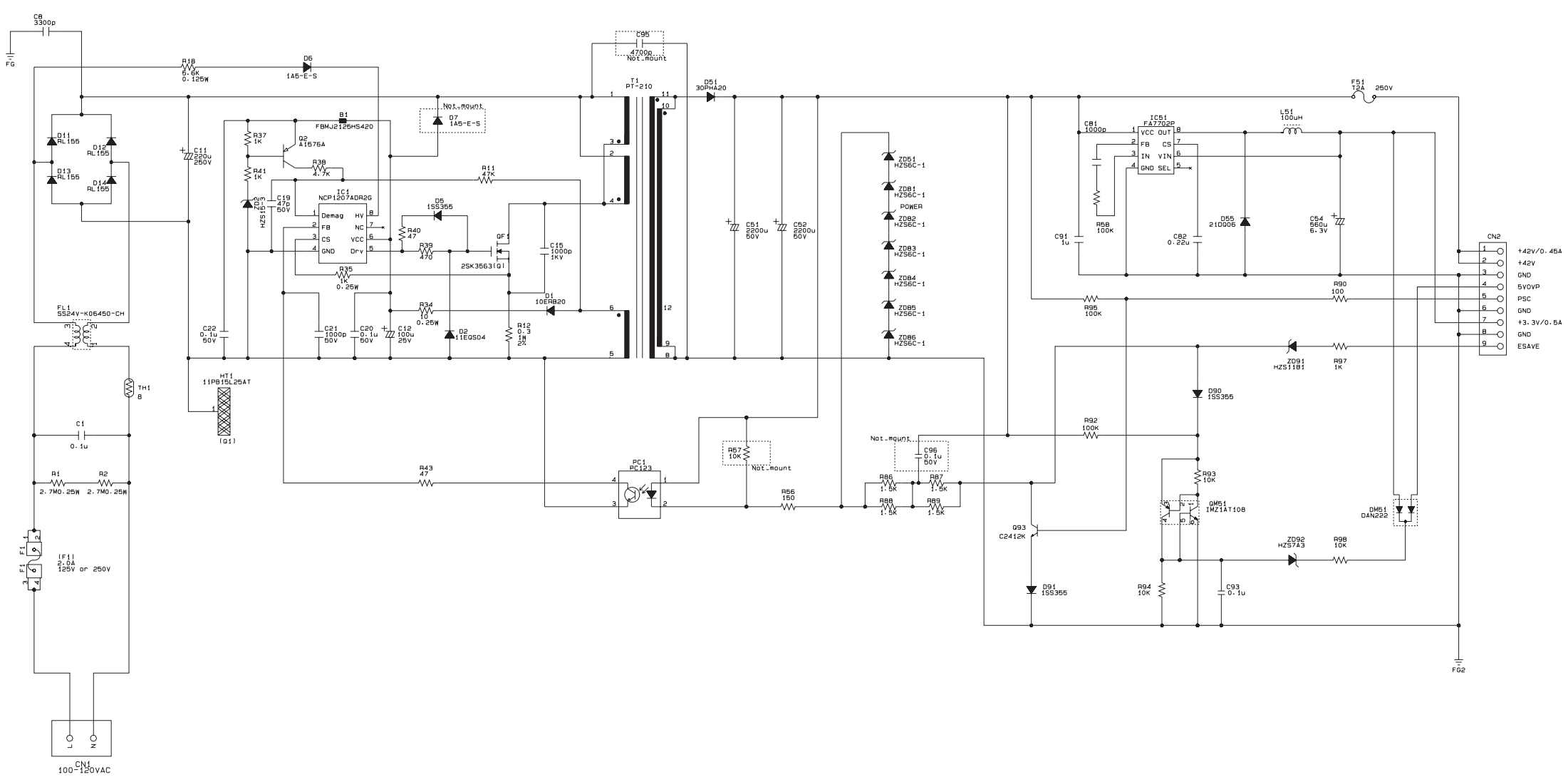

Model: PM-G4500
 Stylus Photo 1390/1400/1410
 Board: C589 PSB
 Rev.: D
 Sheet: 1/1

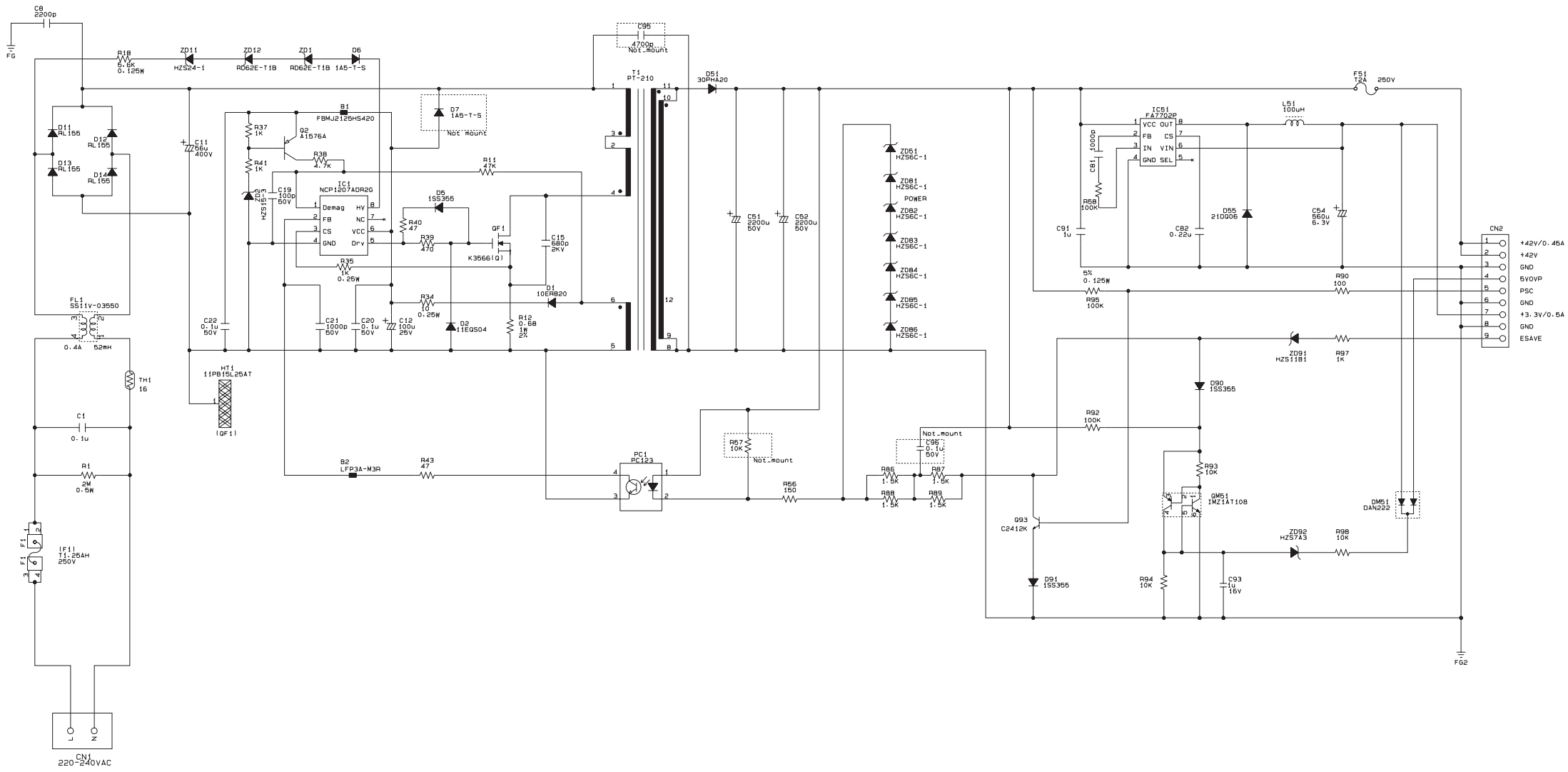

Model: PM-G4500
 Stylus Photo 1390/1400/1410
 Board: C589 PSE
 Rev.: B
 Sheet: 1/1

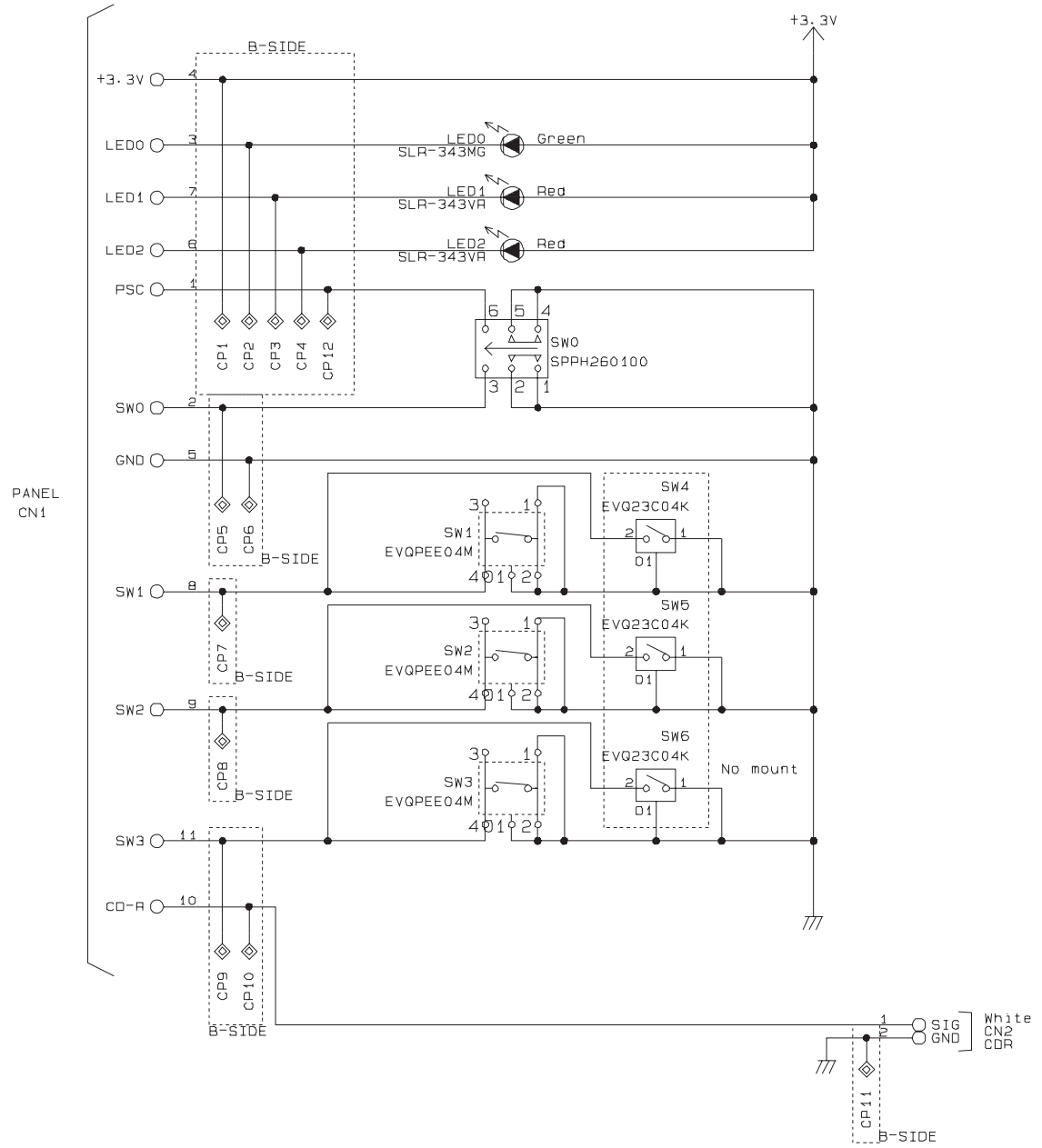

Model: PM-G4500
 Stylus Photo 1390/1400/1410
 Board: C589 Panel
 Rev.: B
 Sheet: 1/1

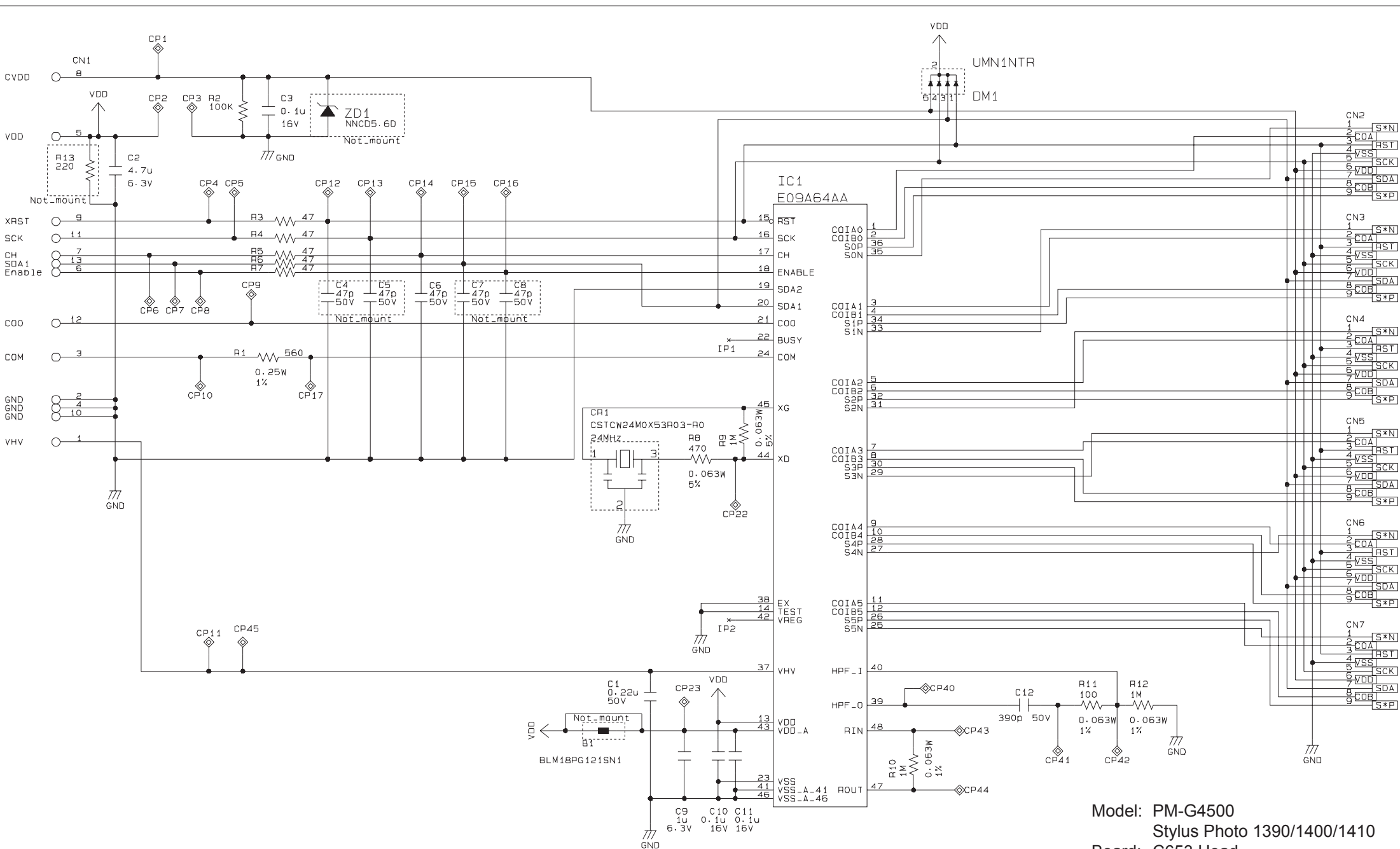

Model: PM-G4500
 Stylus Photo 1390/1400/1410
 Board: C653 Head
 Rev.: B
 Sheet: 1/1